

## MERCHANT GUIDE



**DESIGNED TO HELP YOU PROVIDE THE BEST ADVICE AND INFORMATION ABOUT OUR PRODUCTS.**



Thermal



Fire Safety



Acoustic



Sustainability



Moisture resistance



## ROCK + ROLL

We are the only UK insulation manufacturer to offer a mixed loads service on one vehicle, with no surcharge! Ordering a combination of Glass and Rock Mineral Wool products allows merchants to:

- Improve efficiency
- Free up warehouse space
- Improve stock turn
- Have fewer deliveries to site
- Order with flexibility

## BESPOKE SERVICES

We offer a comprehensive bespoke service to merchants.

- **Growth initiatives**
  - Point of sale support
  - Tailored training packages
  - Product content and images for your website
  - Trade day support
  - Promotional support
- **Flexible load sizes**
  - Quarter load
  - Half load
  - Full load

## WE ARE HERE FOR YOU

We have multiple dedicated teams ready to help and advise you every step of the way:

- Dedicated Merchant Support Team
- Technical Support Team
- Customer Service Team
- Commercial Support Team
- Customer Marketing Team

# CONTENTS

	Page Number		
INTRODUCTION	Mineral Wool Insulation with the Feel Good Factor	4	
	The benefits of Mineral Wool Insulation	5	
	Minimising our environmental impact	6	
	We are the best choice when it comes to performance	8	
	Packaging Updates	10	
	Improvements to our packaging	12	
APPLICATIONS	Application and Product Finder	14	
	Commercial Application Finder	16	
	Residential Application Finder	17	
	Pitched Roof - Ceiling Level	18	
	Pitched Roof - Rafter Level	20	
	Masonry Cavity Walls - Built-In	22	
	Timber Frame Walls - Built-In	26	
	Separating (Party Walls) - Built-In	28	
	Internal Walls	30	
	Internal Floors	32	
	Suspended Timber Ground Floors	34	
	Rainscreen Façade Systems	36	
	Exposed Soffit Floors	38	
	Timber Loft Conversion - Internal Floor	40	
	PRODUCTS	Loft Rolls	19
		Rafter Roll 32	21
		DriTherm® Cavity Slabs	23
		FrameTherm® Rolls & Slab	27
		Party Wall Slabs	29
Acoustic Roll		31	
OmniFit® Rolls		33	
OmniFit® Slab 35		35	
Rocksilk® RainScreen Slabs		37	
Rocksilk® Soffit Linerboards		39	
Rocksilk® Flexible Slab		41	
Rocksilk® Building Slabs		42	
SUPPORTING ASSETS		Product Comparison Chart	44
		PIR Substitution Chart	46
		Our accreditations	49
	Glossary	50	

# MINERAL WOOL INSULATION WITH THE FEEL GOOD FACTOR



**ECOSE® Technology is our unique bio-based binder which is used in the manufacture of all of our Glass Mineral Wool products, and the majority of our Rock Mineral Wool products.**

Our Mineral Wool made with ECOSE® Technology contains no added formaldehyde or phenol. This means our insulation generates very low levels of dust, increasing the comfort of those handling it. ECOSE® Technology makes our insulation soft to touch and easy to handle.

It is made from natural raw materials that are rapidly renewable and is 70% less energy-intensive to manufacture than traditional binders, so it is kinder to the environment too.

## HOW DO YOU KNOW IT'S MANUFACTURED USING ECOSE® TECHNOLOGY?

Products manufactured using ECOSE® Technology have a natural brown colour so you can see, as well as feel the difference.



- Soft to touch
- Low levels of dust
- Low VOCs\*



\*Volatile Organic Compounds

# MINERAL WOOL INSULATION PROVIDES A UNIQUE COMBINATION OF BENEFITS

It is widely known that buildings account for 40% of worldwide carbon emissions, and increasing their energy efficiency continues to be a priority for governments as they try to combat climate change. Whilst the primary role of insulation is to provide thermal performance, choosing the right insulation will also determine a building's acoustic and fire safety properties as well as the level of comfort it provides for its users. Our mineral wool insulation solutions provide a **unique combination of performance**.

## THERMAL



**The energy saving properties and thermal performance of insulation keep buildings warm in winter and cool in summer.**

The bigger the temperature difference between the inside and outside of a building, the faster the building will lose heat in winter and gain heat in summer.

Our Mineral Wool insulation solutions help maintain a stable inside temperature by slowing heat transfer by convection, conduction and radiation.

By insulating a property properly, energy can be saved either from the heating system when heating a cold building, or from the air conditioning system when cooling a warm building.

## ACOUSTIC



**The acoustic performance of insulation can help create an improved internal environment for building occupants.**

Protection from noise contributes towards the 'quality of life' afforded by dwellings, and a healthy, productive and attractive environment in offices, hospitals, schools and other non-domestic buildings.

Our Mineral Wool insulation solutions are the best choice for noise reduction in new build or retrofit when compared to other insulants (i.e. rigid insulation boards). Due to their unique fibre matrix, sound waves become trapped within the fibres, meaning less sound energy passes through increasing the amount of sound reduction.

## FIRE SAFETY



**The fire performance of our insulation gives it the ability to provide passive fire protection.**

Buildings must be designed and constructed to minimise the risk of fire and its spread should it occur, as well as to maximise the structure's stability and the ability of occupants to escape unharmed.

Our non-combustible Mineral Wool insulation solutions provide the best possible A1 and A2-s1,d0 Euroclass reaction to fire classification. This means that, as well as acting as a barrier to the fire, they will not add to its development stages, minimising its overall effect and consequences.



## COMFORT



**Insulation can help create dry, comfortable indoor environments and buildings and have a major impact on the health and wellbeing of their users.**

By preventing air leaks, uncontrolled condensation and possible mould spores, mildew or microbial organic compounds, a well-insulated, airtight building envelope also contributes to the health of a building — particularly if combined with efficient installation of the solutions and a controlled ventilation system.

Our Mineral Wool insulation solutions provide all of the above benefits, but more importantly, thanks to our ECOSE® Technology, they contribute to high levels of indoor air quality and were the world's first products to be awarded the Eurofins Gold Certificate for Indoor Air Comfort.

# USE INSULATION MATERIALS THAT MINIMISE ENVIRONMENTAL IMPACT

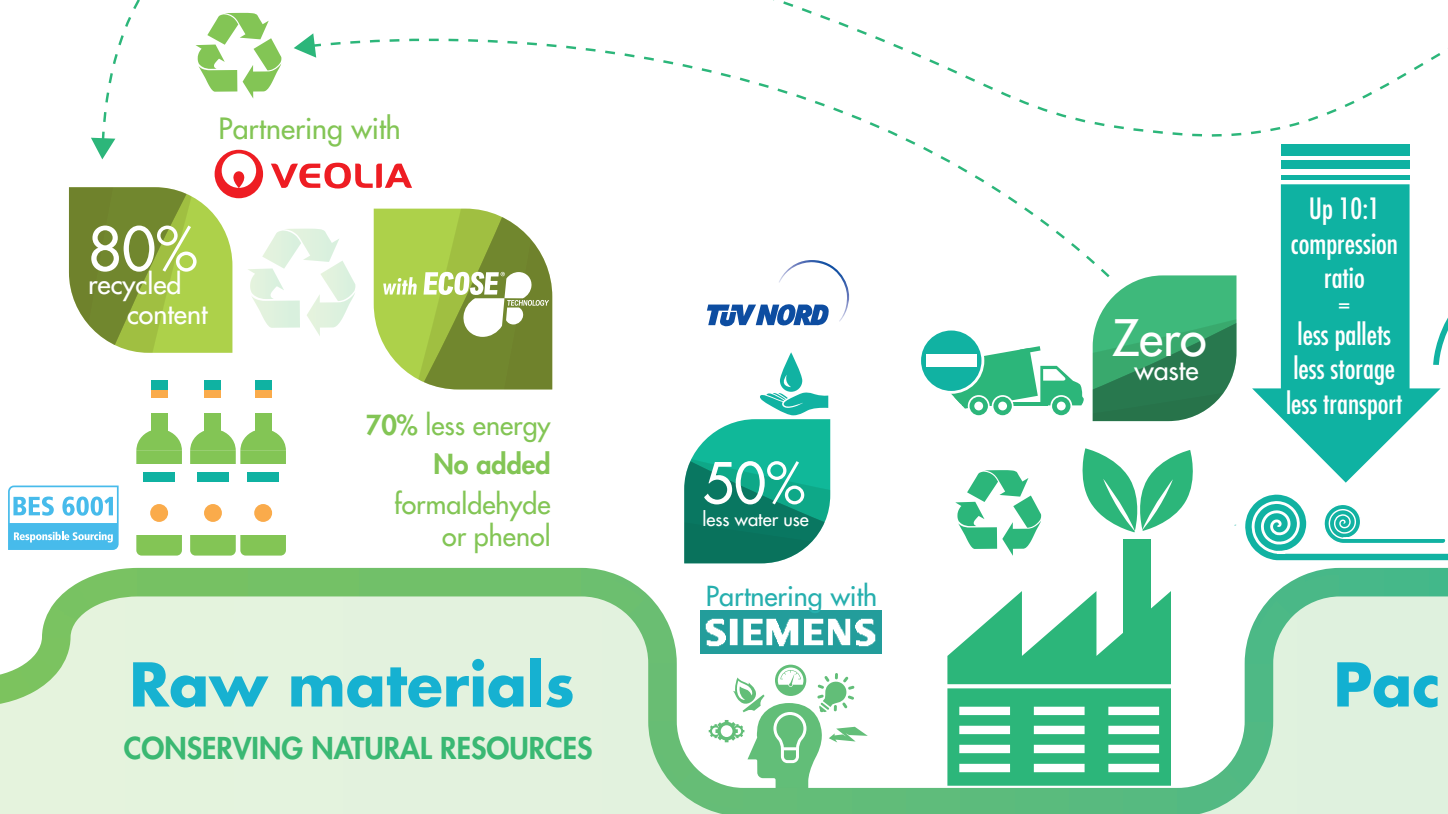

## Raw materials CONSERVING NATURAL RESOURCES

## Manufacturing

### REDUCING THE ENVIRONMENTAL IMPACT OF OUR OWN PROCESSES

**Our Glass Mineral Wool insulation solutions** contain up to 80% recycled content. By maximising the amount of recycled glass in the manufacture of our products, we minimise our need for virgin raw materials.

**Our unique bio-based binder, ECOSE® Technology** contains no added formaldehyde or phenol. It is made from natural raw materials that are rapidly renewable and is 70% less energy-intensive to manufacture than traditional binders, so it is more environmentally-friendly.

**Our work to ensure safe and legal operations in our supply chain** has enabled us to achieve certification to the Building Research Establishment's responsible sourcing standard BES 6001.

**Partnering with Siemens**, we are unlocking efficiency opportunities to reduce our carbon footprint, saving the equivalent annual energy usage of almost 800 homes.

**Our commitment to fair and safe working practices** in our own facilities is embedded in our code of conduct, and reflected in the ISO 45001 certification covering all our production sites.

All our facilities are also certified to ISO 14001 and ISO 50001 standards.

**We avoid waste and prevent pollution;** we segregate factory waste to maximise recycling and to meet our expectation of sending zero waste to landfill from our UK plants.

As the market leader and a non-stop innovator, quality excellence and sustainability are at the heart of everything we do; whilst we have a strong focus on the thermal, fire safety and acoustic performance of our products, our pursuit of sustainability has much wider horizons.

We are dedicated to supplying sustainable high performance insulation solutions for enhanced energy efficiency in buildings, but we also continually strive for improvements in our manufacturing and supply chain operations to improve quality and minimise our impact on the environment. All our production locations have state-of-the-art manufacturing equipment and meet the highest quality standards, supported by an ongoing research and development program.

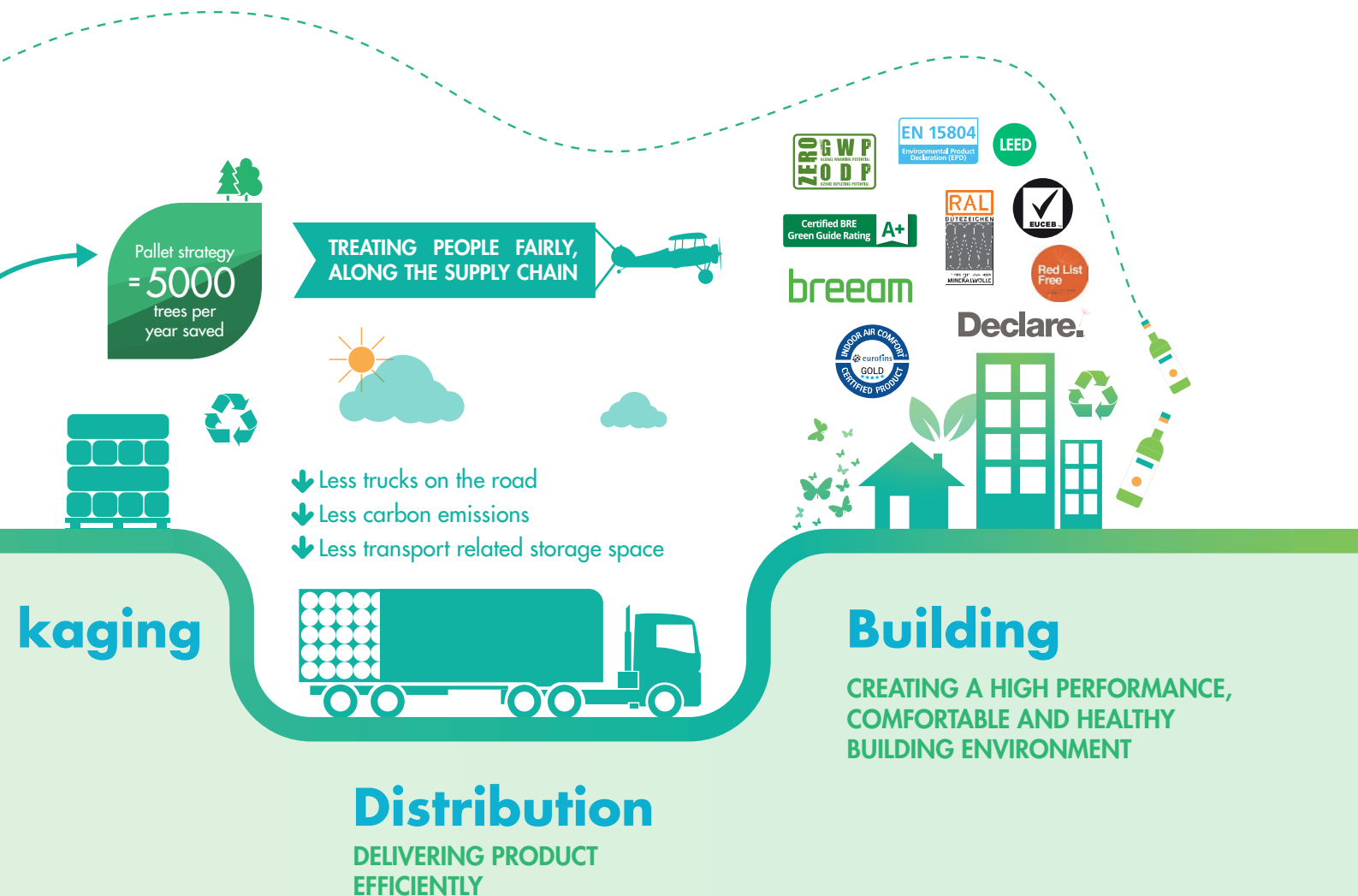

## Packaging

## Distribution

DELIVERING PRODUCT EFFICIENTLY

## Building

CREATING A HIGH PERFORMANCE, COMFORTABLE AND HEALTHY BUILDING ENVIRONMENT

### Packaging 'For A Better World'

We have recently improved our industry-leading compression-packaging, and have been able to further increase the amount of material per pack or pallet for our Glass Mineral Wool products.

This means even fewer trucks on the road, less storage and handling for our customers. In addition, we have re-designed our packaging to be more customer-centric, while reducing the amount of ink by up to 50%.

We are also introducing a new packaging film with a minimum of 30% recycled plastic content. This means the plastic we do use is even easier to recycle and reduces our carbon footprint.

Over the years, we have been trimming the weight of the pallets we use in the UK, cutting around 2kg per pallet, equating to a total saving of around 5,000 trees/year.

### Our products contain very low levels of VOCs

which affect indoor air quality, attested by their certification to Eurofins Gold Certificate for Indoor Air Comfort.

The overall environmental performance of our products is reported in Environmental Product Declarations. They are verified by an independent third-party and comply with the European standard EN 15804.

### Our Glass Mineral Wool and Blowing Wool products

are registered in the BRE's UK-specific Certified Environmental Profiles scheme. The majority of our products have a generic Green Guide rating of A+.

# WE ARE THE BEST CHOICE WHEN IT COMES TO PERFORMANCE

CURED GLASS MINERAL WOOL

There is a broad spectrum of insulation materials available on the market, with an equally broad variance in form, performance, sustainability, cost-effectiveness and availability.

All our Mineral Wool products meet the highest specifications and have demonstrated excellent performance in the most demanding projects, including those built to the Passivhaus standard.

## Cured Glass Mineral Wool

Our high performance Glass Mineral Wool insulation solutions contain up to 80% recycled glass content, to which sand, limestone and soda ash is added, before being melted in a furnace. The molten glass is spun to form millions of fine strands of mineral wool. We use our unique bio-based binder, ECOSE® Technology, to bind the mineral wool together to form a mat of material which is then cured in order to form the final product. The density of the product determines whether the insulation is a lightweight quilt supplied in rolls, a flexible slab or a rigid slab, and its thermal insulation value.

## Rock Mineral Wool

Our Rock Mineral Wool insulation solutions are mainly made from volcanic rock, typically basalt or dolomite. An increasing proportion is now recycled material from slag, a waste product from blast furnaces. The raw materials are melted and then spun into fine strands of wool. A binder is used to bind the wool together to form a mat of insulation, which is then cut into slabs or wired mattresses. Most of our Rock Mineral Wool products use our ECOSE® Technology.

## Industry-leading Compression Packaging

Our industry-leading compression packaging technology (up to 10:1 ratio across our Glass Mineral Wool products) allows for more product per pack, therefore less packaging used, fewer lorries on the roads and reduced transport related carbon emissions. All of which contributes to a low lifecycle impact. It also means our customers require less storage space, and less carrying and handling when compared to other products. As part of our continuous improvement process, we continually strive for further developments in our manufacturing and supply chain operations to enhance quality and minimise our impact on the environment.





ROCK MINERAL WOOL

	Glass Mineral Wool	Rock Mineral Wool	
<b>Features</b>	Naturally non-combustible	✓	
	Compression packed to limit transport & warehouse requirements	✓	
	Strand type	Long strands giving high levels of tear strength	Short strands giving high levels of compressive strength
	Available in slabs	✓	✓
	Available in rolls	✓	
	Available in wired mattresses		✓
	Available with a variety of facings	✓	✓
<b>Applications</b>	Residential buildings	✓	✓
	Commercial buildings	✓	✓
	New build	✓	✓
	Refurbishment	✓	✓
	Fire Protection*		✓

\*Specialist fire protection products only, consult our technical services team for more information.



Thermal

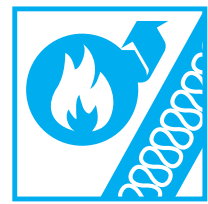

Fire Safety



Acoustic

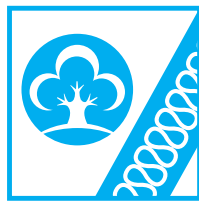

Sustainability



Moisture resistance

# OUR NEW PACKAGING

	OLD	NEW
Loft Roll 44		
Loft Roll 40		
Rafter Roll 32		
DriTherm® Cavity Slab 37		
DriTherm® Cavity Slab 34		
DriTherm® Cavity Slab 32		
FrameTherm® Roll 40		
FrameTherm® Roll 35		
FrameTherm® Roll 32		
FrameTherm® Slab 32		

OLD

NEW

Timber Frame Party Wall Slab



Masonry Party Wall Slab



OmniFit® Roll 40



OmniFit® Roll 34  
Formerly OmniFit® Stud



OmniFit® Slab 35



Acoustic Roll



Rocksilk® RainScreen Slab



Rocksilk® Flexible Slab



Rocksilk® RS45



Rocksilk® RS60



Rocksilk® RS80 & RS100





# NEW ROCK PACKAGING DESIGN



- **Knauf Insulation logo** — big and bold for better brand visibility
- **Rocksilk® brand introduced** —
- **Name of product big and clear** — for easier product identification

- **ECOSE® technology key messages** — highlighting the benefits to end-user
- **Packaging For A Better World mark** — reinforcing packaging sustainability credentials
- **Euroclass A1 Non-combustible logo and wording** — for fire safety assurance and compliance
- **Clear labelling of key product information and certifications** — for easier identification and compliance

Rocksilk® RainScreen Slab	
THICKNESS (mm)	1200
<b>100</b>	600
	2.880
	2.90
	0.034
	4
	A1
CE	1423151771111
	640914
	ROCK MINERAL WOOL



# APPLICATION AND PRODUCT FINDER

Whatever your application, we have a product that does the job!



Loft Rolls

Rafter Roll 32

DriTherm®  
Cavity Slabs

FrameTherm®  
Roll/Slabs

Party Wall Slabs

Acoustic Roll

		Loft Rolls	Rafter Roll 32	DriTherm® Cavity Slabs	FrameTherm® Roll/Slabs	Party Wall Slabs	Acoustic Roll
ROOF	<b>Pitched Roof Ceiling Level</b>	🏠	-	-	-	-	-
	<b>Pitched Roof Rafter Level</b>	-	🏠	-	🏠	-	-
WALL	<b>Masonry Cavity Walls</b>	-	-	🏠	-	-	-
	<b>Timber Frame Walls</b>	-	-	-	🏠	-	-
	<b>Separating Party Walls</b>	-	-	-	-	🏠	-
	<b>Internal Walls</b>	-	-	-	-	-	🏠
FLOOR	<b>Rainscreen Façade Systems</b>	-	-	-	-	-	-
	<b>Internal Floors</b>	-	-	-	-	-	🏠
	<b>Suspended Ground Floors</b>	-	-	-	-	-	-
	<b>Exposed Soffits</b>	-	-	-	-	-	-

## Key



Primary application



Also suitable



OmniFit® Slab 35



OmniFit® Roll 34



OmniFit® Roll 40



Rocksilk® Flexible Slab



Rocksilk® Building Slabs



Rocksilk® RainScreen Slabs



Rocksilk® Soffit Linerboards

-			-	-	-	-
		-			-	-
-	-	-	-	-	-	-
		-			-	-
-	-	-	-	-	-	-
					-	-
						-
					-	-
					-	-
-	-	-	-	-	-	

# SOLUTIONS FOR ALL APPLICATIONS

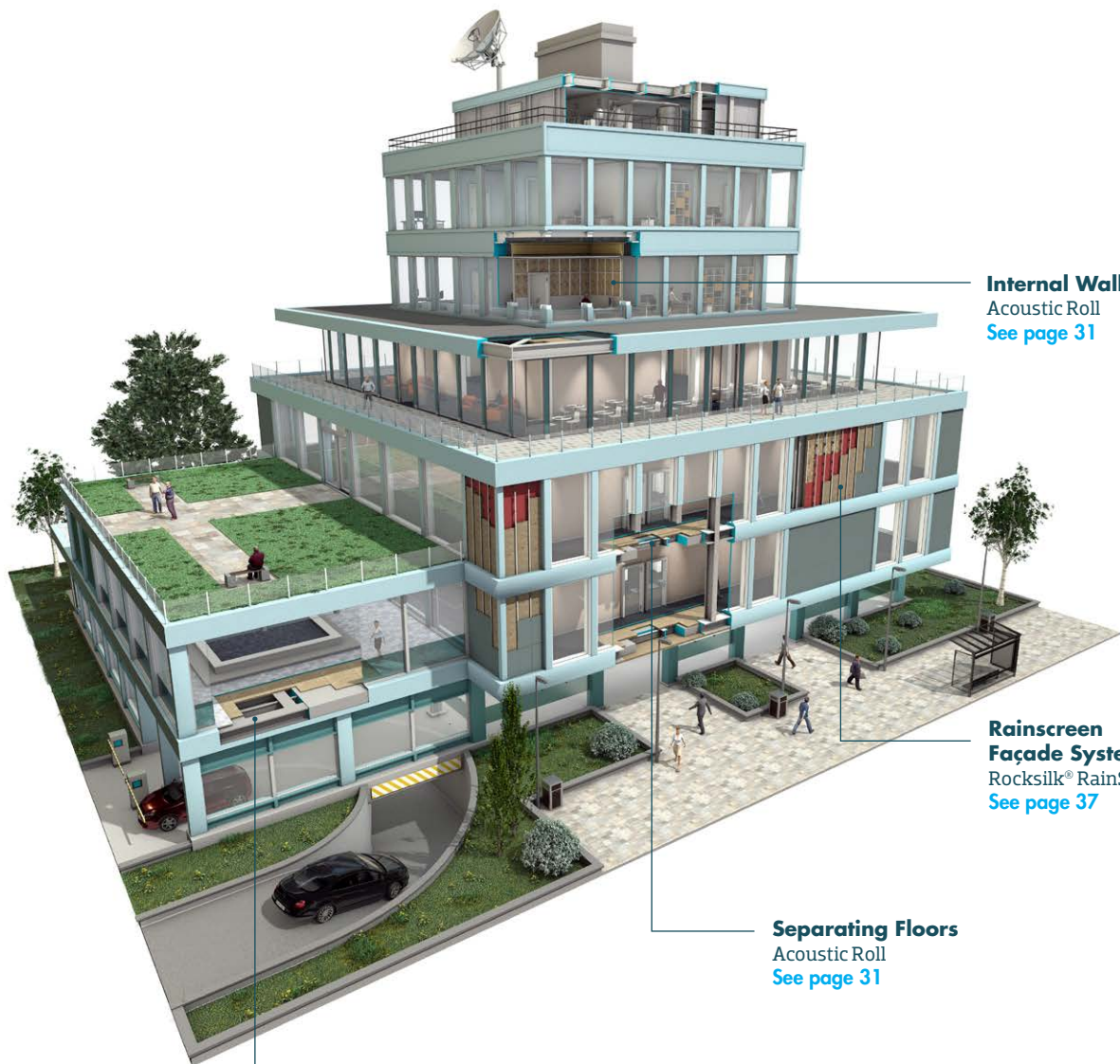

**Internal Walls**  
Acoustic Roll  
See page 31

**Rainscreen Façade Systems**  
Rocksilk® RainScreen Slabs  
See page 37

**Separating Floors**  
Acoustic Roll  
See page 31

**Exposed Soffits**  
Rocksilk® Soffit  
Linerboards  
See page 39



Recommended products for each application, other products are suitable.  
See application pages for more information.

**Pitched Roof  
(rafter level)**

Rafter Roll 32  
See page 21

**Timber Loft Conversion -  
Internal Floor**

Rocksilk® Flexible Slab  
See page 41

**Separating (Party) Walls (built-in)**

Masonry Party Wall Slab  
Timber Frame Party Wall Slab\*  
See page 29

**Pitched Roof  
(ceiling level)**

Loft Rolls  
See page 19

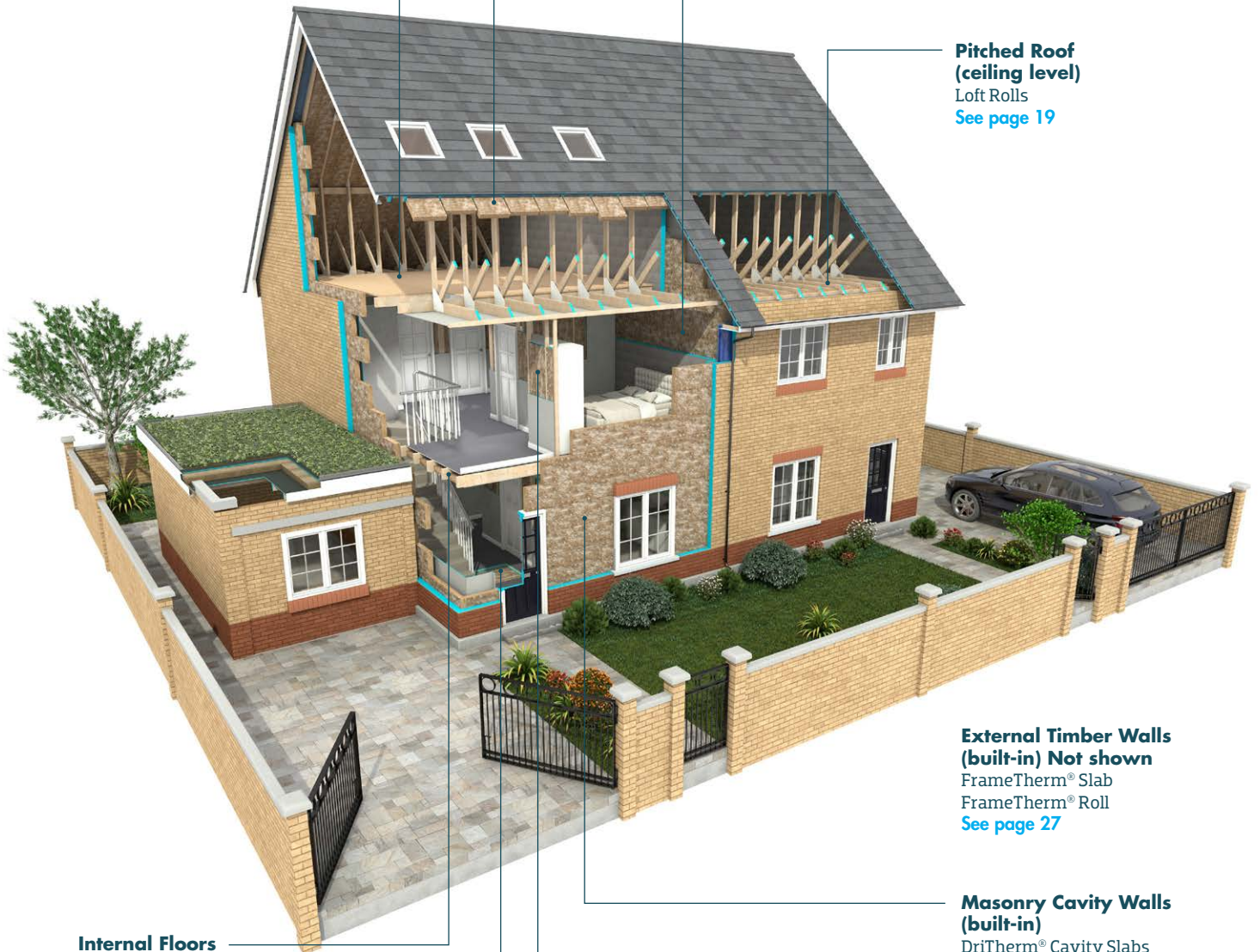

**Internal Floors**

Acoustic Roll  
See page 31

**Suspended Timber Ground Floors**

OmniFit® Slab 35  
See page 35

**External Timber Walls  
(built-in) Not shown**

FrameTherm® Slab  
FrameTherm® Roll  
See page 27

**Masonry Cavity Walls  
(built-in)**

DriTherm® Cavity Slabs  
See page 23

**Internal Walls**

Acoustic Roll  
See page 31

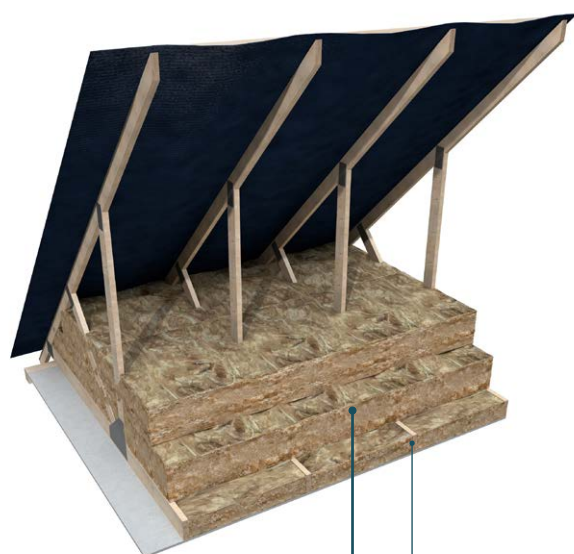

**Loft Roll 44**  
between and above ceiling joists

Ceiling joist



### APPLICATION OVERVIEW

Insulation in cold lofts is installed in a number of layers with the first layer being laid between ceiling joists, and subsequent layers being laid at right angles to the ceiling joists, with all edges butted to prevent thermal bridging and unwanted heat loss.

The principle consideration is thermal performance. Our loft insulation solutions provide excellent levels of thermal resistance in relation to cost of installation as thickness is largely unrestricted.

### RECOMMENDED PRODUCTS

- **Loft Roll 44** (see page 19)

### OTHER SUITABLE PRODUCTS

- **Loft Roll 40** (see page 19)
- **OmniFit® Roll 40** (see page 33)

### PITCHED ROOF - CEILING LEVEL

		U-value (W/m <sup>2</sup> K)	Between joists		Top layer	
			Product	Thickness	Product	Thickness
Refurbishment	Minimum required	0.16	Loft Roll 44	100mm	Loft Roll 44	170mm
	Medium performance	0.15	Loft Roll 44	100mm	Loft Roll 44	200mm
	Recommended	0.11	Loft Roll 44	100mm	Loft Roll 44	300mm (2 x 150)
New build	Recommended	0.11	Loft Roll 44	100mm	Loft Roll 44	300mm (2 x 150)
	High performance	0.09	Loft Roll 44	100mm	Loft Roll 40	400mm (2 x 200)

Current building regulations for loft insulation at ceiling level require a depth of 270-300mm insulation. This is achieved by using 2 layers of insulation; one base layer of insulation lengthwise between the joists and a top up or a super top up layer in a 'cross-layered' formation, at right angles to the joists.

# LOFT ROLLS

FOR PITCHED ROOF (COLD ROOF / LOFT INSULATION)



**NON-COMBUSTIBLE  
INSULATION**



## LOFT ROLL 40 (COMBI-CUT)

Thickness (mm)	Thermal conductivity (W/mK)	Thermal resistance (m <sup>2</sup> K/W)	Length (m)	Width (mm)	Area per pack (m <sup>2</sup> )	Rolls per pallet	Pallet product code
200	0.040	5.00	4.85	1140 (2x570/3x380)	5.529	24	2404169
150	0.040	3.75	7.53	1140 (2x570/3x380)	8.584	24	2404166
100	0.040	2.50	11.25	1140 (2x570/3x380)	12.825	24	2404167

## LOFT ROLL 44 (COMBI-CUT)

Thickness (mm)	Thermal conductivity (W/mK)	Thermal resistance (m <sup>2</sup> K/W)	Length (m)	Width (mm)	Area per pack (m <sup>2</sup> )	Rolls per pallet	Pallet product code
200	0.044	4.55	6.00	1140 (2x570/3x380)	6.840	24	715820
170	0.044	3.86	7.03	1140 (2x570/3x380)	8.014	24	2404156
150	0.044	3.41	8.05	1140 (2x570/3x380)	9.177	24	2404155
100	0.044	2.27	12.18	1140 (2x570/3x380)	13.885	24	2404154

## LOFT ROLL 44 (COMBI-CUT) SHORTER LENGTHS

Thickness (mm)	Thermal conductivity (W/mK)	Thermal resistance (m <sup>2</sup> K/W)	Length (m)	Width (mm)	Area per pack (m <sup>2</sup> )	Rolls per pallet	Pallet product code
200	0.044	4.50	3.40	1140 (2x570/3x380)	3.876	40	244329
170	0.044	3.85	4.30	1140 (2x570/3x380)	4.902	40	244328
150	0.044	3.40	4.90	1140 (2x570/3x380)	5.586	40	244327
100	0.044	2.25	7.28	1140 (2x570/3x380)	8.299	40	244326

## LOFT ROLL 44 (READY-CUT)

Thickness (mm)	Thermal conductivity (W/mK)	Thermal resistance (m <sup>2</sup> K/W)	Length (m)	Width (mm)	Area per pack (m <sup>2</sup> )	Rolls per pallet	Pallet product code
150	0.044	3.40	8.05	2x570	9.177	24	2404163
100	0.044	2.25	12.18	2x570	13.885	24	2404161

All dimensions are nominal



Generic BRE Green Guide Rating **A+**



Declare.





### APPLICATION OVERVIEW

Insulation is friction-fitted between rafters, with the option to underline the rafters with a layer of non-combustible insulation to further enhance thermal performance.

As rooms-in-roof are usually used as bedrooms, acoustic performance and noise reduction of external noise should be considered in addition to thermal performance.

Our insulation solutions for warm roofs provide thermal efficiency, whilst also contributing to acoustic performance.



LR underlay  
**Rafter Roll 32**  
**Rocksilk® RS45**  
 Vapour control layer

### RECOMMENDED PRODUCTS

(Between rafters)

- **Rafter Roll 32** (see page 21)

### OTHER SUITABLE PRODUCTS

(Between rafters)

- **FrameTherm® Rolls and Slabs** (see page 27)
- **OmniFit® Slab 35** (see page 35)
- **OmniFit® Roll 34** (see page 33)
- **Rocksilk® Flexible Slab** (see page 41)
- **Rocksilk® RS45** (see page 42)

### RECOMMENDED PRODUCTS

(Beneath rafters)

- **Rocksilk® RS45** (see page 42)

## PITCHED ROOF – RAFTER LEVEL

Rafter Roll 32 thickness (mm)	U-value (W/m <sup>2</sup> K)	
	Rocksilk® RS45 thickness (mm)	
	25	50
250 (100 + 2x75)	0.14	0.13
225 (3 x 75)	0.15	0.14
200 (2 x 100)	0.17	0.15
175 (100 + 75)	0.19	0.17
150 (2 x 75)	0.21	0.18
100 (1 x 100)	0.28	0.24

Note: Rafter sizes assumed to be 38mm wide at 600mm centres (6.3% bridging and the same depth as the insulation). Rocksilk® RS45 (0.035 W/mK) installed internally between 47mm wide timber battens at 600mm centres. (12% bridging and the same depth as the insulation layer). 12.5mm Plasterboard internal finish (λ0.190).

# RAFTER ROLL 32

FOR RAFTER LEVEL (WARM ROOF)



**NON-COMBUSTIBLE  
INSULATION**

## RAFTER ROLL 32 (UNCUT)

Thickness (mm)	Thermal conductivity (W/mK)	Thermal resistance (m <sup>2</sup> K/W)	Length (m)	Width (mm)	Area per pack (m <sup>2</sup> )	Rolls per pallet	Pallet product code
100	0.032	3.10	4.00	1200	4.800	24	2402020
75	0.032	2.30	5.25	1200	6.300	24	2402018

*All dimensions are nominal.*



Generic BRE  
Green Guide Rating **A+**

EPD<sup>®</sup>  
THE INTERNATIONAL EPD<sup>®</sup> SYSTEM



Declare.



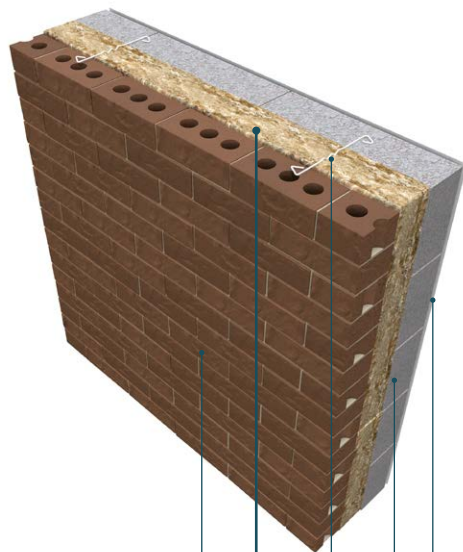

Brick outer leaf  
**DriTherm® Cavity Slab 32**  
 Suitable wall tie  
 Blockwork inner leaf  
 Plasterboard on dabs



### APPLICATION OVERVIEW

Full-fill built-in insulation solutions are installed as the walls are built, with slabs being friction-fitted between the inner and outer leaves of the wall and in between wall ties.

The principle consideration is thermal performance with a requirement for the insulation to be in intimate contact with both leaves of the wall to prevent air movement and subsequent heat loss.

Our non-combustible DriTherm® Cavity Slabs are designed to fully fill the cavity and are BBA certified for use in all exposure zones.

### RECOMMENDED PRODUCT

- **DriTherm® Cavity Slab 32** (see page 23)

### OTHER SUITABLE PRODUCTS

- **DriTherm® Cavity Slab 34** (see page 23)
- **DriTherm® Cavity Slab 37** (see page 23)

## MASONRY CAVITY WALLS

		U-value (W/m <sup>2</sup> K)	Lightweight aggregate block (0.28W/mK)		Standard aircrete block (0.15W/mK)	
			Product	Thickness	Product	Thickness
Extensions	Minimum required	≤0.28	DriTherm® Cavity Slab 32	100mm	DriTherm® Cavity Slab 37	100mm
	Recommended	≤0.26	DriTherm® Cavity Slab 32	100mm	DriTherm® Cavity Slab 32	100mm
New build	Recommended	≤0.25	DriTherm® Cavity Slab 32	125mm	DriTherm® Cavity Slab 32	100mm
	Wales	≤0.21	DriTherm® Cavity Slab 32	125mm	DriTherm® Cavity Slab 32	100mm
	High performance	≤0.18	DriTherm® Cavity Slab 32	150mm	DriTherm® Cavity Slab 32	150mm

U-value figures are in line with UK Building Regulations. For construction projects in Ireland, please contact Technical Support on 01744 766 666.

# DRITHERM® CAVITY SLABS

FOR MASONRY CAVITY WALLS (BUILT-IN)



## DRITHERM® CAVITY SLAB 32

Thickness (mm)	Thermal conductivity (W/mK)	Thermal resistance (m <sup>2</sup> K/W)	Length (mm)	Width (mm)	Slabs per pack	Area per pack (m <sup>2</sup> )	Packs per pallet	Pallet product code
150	0.032	4.65	1200	455	4	2.184	30	580216
125	0.032	3.91	1200	455	4	2.184	40	715828
100	0.032	3.13	1200	455	6	3.276	30	715829
85	0.032	2.66	1200	455	5	2.730	45	715830
75	0.032	2.34	1200	455	6	3.276	45	715827

## DRITHERM® CAVITY SLAB 34

Thickness (mm)	Thermal conductivity (W/mK)	Thermal resistance (m <sup>2</sup> K/W)	Length (mm)	Width (mm)	Slabs per pack	Area per pack (m <sup>2</sup> )	Packs per pallet	Pallet product code
150	0.034	4.41	1200	455	5	2.730	30	715834
125	0.034	3.68	1200	455	6	3.276	30	715836
100	0.034	2.94	1200	455	8	4.368	30	715832
75	0.034	2.21	1200	455	10	5.460	30	715833

## DRITHERM® CAVITY SLAB 37

Thickness (mm)	Thermal conductivity (W/mK)	Thermal resistance (m <sup>2</sup> K/W)	Length (mm)	Width (mm)	Slabs per pack	Area per pack (m <sup>2</sup> )	Packs per pallet	Pallet product code
150	0.037	4.05	1200	455	8	4.368	25	715835
125	0.037	3.35	1200	455	6	3.276	40	316660
100	0.037	2.70	1200	455	12	6.552	25	715831
85	0.037	2.25	1200	455	8	4.368	45	316656
75	0.037	2.00	1200	455	8	4.368	50	316654
65	0.037	1.80	1200	455	10	5.460	40	316652
50	0.037	1.40	1200	455	12	6.552	30	316650

All dimensions are nominal



# DRITHERM® CAVITY SLAB

## BUILDING REQUIREMENTS



### DRITHERM® CAVITY SLAB 32

DriTherm® Cavity Slab 32 thickness (mm)	U-value (W/m <sup>2</sup> K)			
	Medium block (0.45 W/mK)	High strength aircrete (0.19 W/mK)	Standard aircrete (0.15 W/mK)	Lightweight aircrete (0.11 W/mK)
300 (2 x 150mm)	0.11	0.10	0.10	0.10
200 (2 x 100mm)	0.15	0.15	0.14	0.14
150	0.19	0.18	0.17	0.17
125	0.22	0.21	0.20	0.20
100	0.26	0.25	0.24	0.23



### DRITHERM® CAVITY SLAB 34

DriTherm® Cavity Slab 34 thickness (mm)	U-value (W/m <sup>2</sup> K)			
	Medium block (0.45 W/mK)	High strength aircrete (0.19 W/mK)	Standard aircrete (0.15 W/mK)	Lightweight aircrete (0.11 W/mK)
300 (3 x 100mm)	0.11	0.11	0.11	0.10
200 (2 x 100mm)	0.16	0.15	0.15	0.15
150 (2 x 75mm)	0.20	0.19	0.18	0.18
125	0.23	0.22	0.21	0.20
100	0.27	0.26	0.25	0.24



### DRITHERM® CAVITY SLAB 37

DriTherm® Cavity Slab 37 thickness (mm)	U-value (W/m <sup>2</sup> K)			
	Medium block (0.45 W/mK)	High strength aircrete (0.19 W/mK)	Standard aircrete (0.15 W/mK)	Lightweight aircrete (0.11 W/mK)
300 (2 x 150mm)	0.12	0.12	0.11	0.11
200 (2 x 100mm)	0.17	0.16	0.16	0.16
150	0.21	0.20	0.20	0.19
125	0.25	0.23	0.23	0.22
100	0.29	0.27	0.27	0.26



# WORRIED ABOUT PROVIDING BAD ADVICE? RECOMMENDING NON-COMBUSTIBLE SOLUTIONS GIVES PEACE OF MIND TO YOU AND YOUR CUSTOMER

## Reaction to Fire and Fire Resistance are two different, but very important considerations when it comes to designing a building.

Our non-combustible Mineral Wool insulation solutions offer the best performance when it comes to both reaction to fire and fire resistance, enabling building designers and specifiers to develop effective and robust fire safety strategies when they design new buildings.

**REACTION TO FIRE** - How quickly will the fire develop?

The measurement of how a material or system will contribute to the fire development and spread, particularly in the very early stages of a fire when evacuation is crucial.

By choosing non-combustible insulation materials, building designers and specifiers can design out the risk of fire within the building fabric from the start.

Using non-combustible materials minimises the risk that the building fabric will contribute to the development of the fire or contribute to fire spread.

**FIRE RESISTANCE** - How long can the construction withstand the fire?

The measurement of the ability of a material or system to resist, and ideally prevent, the passage of fire from one distinct area to another.

Our non-combustible solutions help inhibit fire spread, maintain structural integrity and limit the spread of smoke from one area to another, providing safe buildings for occupants, and added peace of mind for specifiers.

## TYPICAL INSULATION PRODUCT EUROCLASS REACTION TO FIRE CLASSIFICATIONS

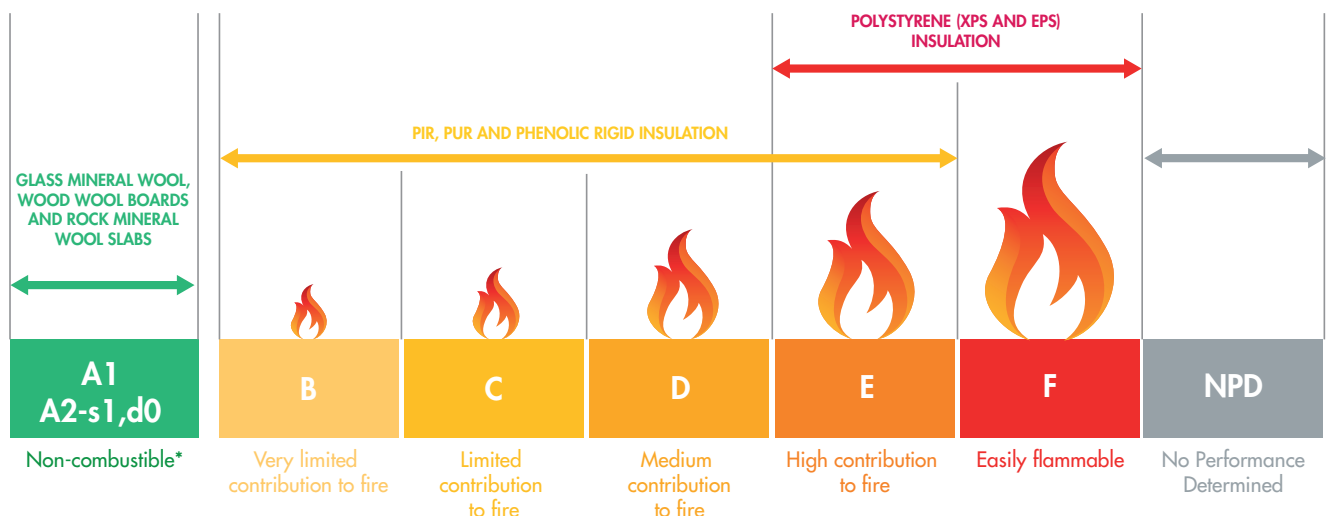

\*As set out in changes to the Building Regulations 2010 which bans the use of combustible materials, limiting the use of materials to those that achieve A1 or A2-s1,d0 on buildings in scope of the ban (as defined in regulation 7(4))

Notes: Other classifications of smoke and flaming droplets within A2 are classed as limited combustibility. (Not shown here as no insulant falls in that category).  
Flames are illustrative only.

NPD = No Performance Determined. In this instance no performance is declared and information regarding reaction to fire performance is unknown.  
Illustration for guidance only. It is crucial to check the actual Euroclass reaction to fire classification of a product before use.

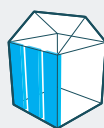
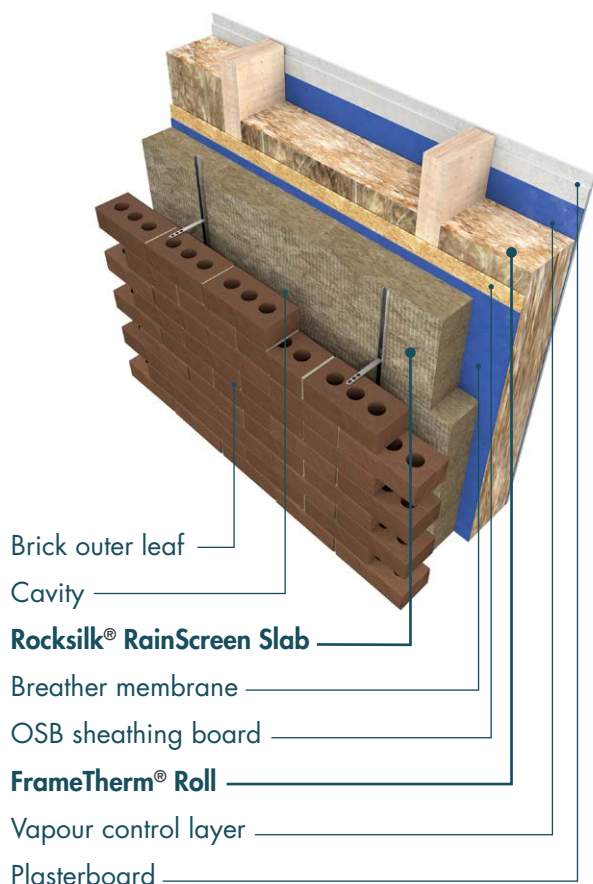

#### APPLICATION OVERVIEW

Mineral Wool rolls or slabs are friction-fitted between timber studs, additional non-combustible insulation partially filling the external cavity to further enhance thermal performance.

Insulation used to partially fill the cavity in timber frame buildings to enhance thermal performance, means the reaction to fire classification of products used should be considered to minimise the chance of fire spread through the cavity. In addition, the reduced mass of timber frame walls means that insulation materials need to provide a higher level of acoustic performance to compensate

Our non-combustible solutions for timber frame buildings are designed to friction fit between studs to minimise heat loss, whilst also providing acoustic absorption to enhance the overall acoustic performance of the wall.

#### RECOMMENDED PRODUCTS

- **FrameTherm® Roll** (see page 27)

#### OTHER SUITABLE PRODUCTS

- **FrameTherm® Slabs** (see page 27)
- **OmniFit® Slab 35** (see page 35)
- **Rocksilks® Flexible Slab** (see page 41)
- **Rocksilks® RS45** (see page 42)

#### RECOMMENDED PRODUCT

(Partially filling cavity)

- **Rocksilks® RainScreen Slab** (see page 37)

### TIMBER FRAME WALLS

		U-value (W/m <sup>2</sup> K)	Between studs	
			Product	Thickness
Extensions		0.25	FrameTherm® Roll 40	140mm
	Recommended	0.25	FrameTherm® Roll 40	140mm
New build	Wales	0.21*	FrameTherm® Roll 40	140mm
	High performance	0.19*	FrameTherm® Roll 32	140mm

Notes: Timber bridging is assumed at 15% and the stud depth is taken to be the same thickness of insulation specified. U-value figures are in line with UK Building Regulations. For construction projects in Ireland, please contact Technical Support on 01744 766 666. \*U-value of 0.19W/m<sup>2</sup>K & 0.21W/m<sup>2</sup>K achieved using service void and low emissivity VCL.

# FRAMETHERM® ROLLS & SLAB

FOR TIMBER FRAME WALLS (BUILT-IN)



**NON-COMBUSTIBLE  
INSULATION**



## FRAMETHERM® ROLL 32 (READY-CUT)

Thickness (mm)	Thermal conductivity (W/mK)	Thermal resistance (m <sup>2</sup> K/W)	Length (m)	Width (mm)	Area per pack (m <sup>2</sup> )	Rolls per pallet	Pallet product code
140	0.032	4.35	2.80	2x570	3.192	24	2435999
90	0.032	2.80	4.50	2x570	5.130	24	2402014
140	0.032	4.35	2.80	3x380	3.192	24	292208
90	0.032	2.80	4.50	3x380	5.130	24	605745

## FRAMETHERM® ROLL 35 (READY-CUT)

Thickness (mm)	Thermal conductivity (W/mK)	Thermal resistance (m <sup>2</sup> K/W)	Length (m)	Width (mm)	Area per pack (m <sup>2</sup> )	Rolls per pallet	Pallet product code
140	0.035	4.00	3.90	2x570	4.446	24	2407395
90	0.035	2.55	6.00	2x570	6.840	24	2407396
140	0.035	4.00	3.90	3x380	4.446	24	605754
90	0.035	2.55	6.00	3x380	6.840	24	605752

## FRAMETHERM® ROLL 40 (READY-CUT)

Thickness (mm)	Thermal conductivity (W/mK)	Thermal resistance (m <sup>2</sup> K/W)	Length (m)	Width (mm)	Area per pack (m <sup>2</sup> )	Rolls per pallet	Pallet product code
140	0.040	3.50	8.02	2x570	9.143	24	498560
90	0.040	2.25	12.50	2x570	14.250	24	498196

All dimensions are nominal.



## FRAMETHERM® SLAB 32

Thickness (mm)	Thermal conductivity (W/mK)	Thermal resistance (m <sup>2</sup> K/W)	Length (m)	Width (mm)	Area per pack (m <sup>2</sup> )	Slabs per pallet	Pallet product code
140	0.032	4.35	1170	570	2.668	16	2438531

All dimensions are nominal.



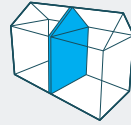

## APPLICATION OVERVIEW

Full-fill built-in insulation solutions are installed as the walls are built, with slabs being friction-fitted between the inner and outer leaves of the wall and in between wall ties.

Insulation is required to prevent heat loss via convection by fully filling the cavity to prevent an unwanted chimney effect, in addition to sound reduction to prevent noise transferring between dwellings.

Our non-combustible insulation solutions for party walls allow a zero-effective U-value to be claimed in SAP and are compliant with a wide range of constructions included in the Robust Details Handbook to demonstrate high levels of acoustic performance.

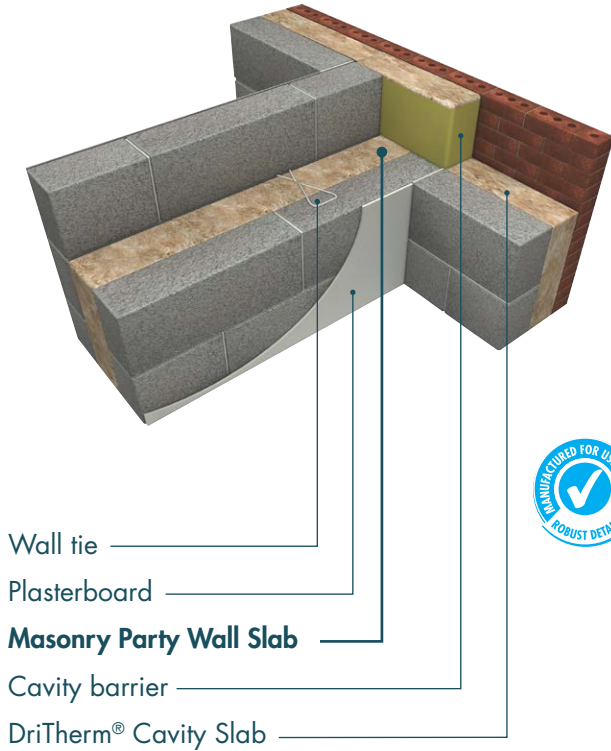

## RECOMMENDED PRODUCTS

- **Masonry Party Wall Slab** (see page 29)

## OTHER SUITABLE PRODUCTS

(Timber Frame Construction)

- **Timber Frame Party Wall Slab** (see page 29)

## SEPARATING (PARTY) WALLS

Performance Level	U-value (W/m <sup>2</sup> K)	Wall Type	Product	Thickness(i)
Recommended	Zero	Masonry	Masonry Party Wall Slab	100mm
				75mm
		Timber Frame	Timber Frame Party Wall Slab	85mm
				60mm

(i) Fully filling and effectively edge sealing the cavity between dwellings to the appropriate thickness will allow a zero effective U-value to be used within SAP

Image shown above is Masonry build up, Timber Frame not shown

# PARTY WALL SLABS

FOR MASONRY AND TIMBER FRAME  
SEPARATING PARTY WALLS



NON-COMBUSTIBLE  
INSULATION



## MASONRY PARTY WALL SLAB

Thickness (mm)	Density (kg/m <sup>3</sup> )	Length (mm)	Width (mm)	Slabs per pack	Area per pack (m <sup>2</sup> )	Packs per pallet	Pallet product code
100	18.00	1200	455	12	6.552	20	2441353
75	18.00	1200	455	16	8.736	20	2441351

All dimensions are nominal.



NON-COMBUSTIBLE  
INSULATION



## TIMBER FRAME PARTY WALL SLAB

Thickness (mm)	Density (kg/m <sup>3</sup> )	Length (mm)	Width (mm)	Slabs per pack	Area per pack (m <sup>2</sup> )	Packs per pallet	Pallet product code
85	18.00	1200	600	12	8.640	16	2441340
60	18.00	1200	600	16	11.520	16	2441338

All dimensions are nominal.



Generic BRE Green Guide Rating **A+**



Declare.



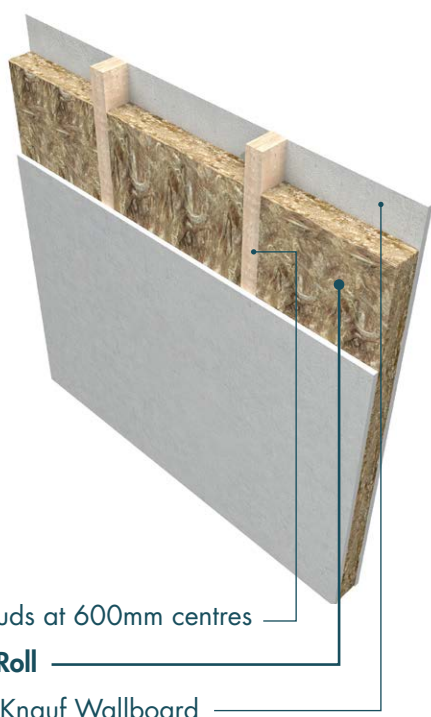

## APPLICATION OVERVIEW

Acoustic insulation is installed between two leaves of plasterboard. Variables within the system can include the type of plasterboard used, the types of studwork used and the orientation of studwork, all of which can be varied to provide differing levels of performance.

In addition to high levels of mass which is provided by the plasterboard layers, absorbent insulation is used to improve the sound reduction properties of internal walls. In certain buildings there may also be specific fire resistance requirements for walls between specific room types.

Our non-combustible solutions for internal walls provide the high levels of absorption required to contribute to excellent levels of sound reduction, and can also help towards high levels of fire resistance where required.

## RECOMMENDED PRODUCT

- **Acoustic Roll** (see page 31)

## OTHER SUITABLE PRODUCTS

- **OmniFit® Slab 35** (see page 35)
- **Rocksilk® Flexible Slab** (see page 41)
- **Rocksilk® RS45** (see page 42)

INTERNAL WALLS				
Stud type	Performance level	Plasterboard	Product	Thickness
48mm metal C stud	Minimum sound insulation required (40 R <sub>w</sub> dB)	1 layer 12.5mm standard plasterboard on each side (i)	Acoustic Roll	25mm
	Recommended	1 layer 12.5mm standard plasterboard on each side (i)	Acoustic Roll	50mm
63mm timber stud	Minimum sound insulation required (40 R <sub>w</sub> dB)	1 layer 12.5mm acoustic plasterboard on each side (ii)	Acoustic Roll	25mm
	Recommended	1 layer 12.5mm standard plasterboard on each side (i)	Acoustic Roll	50mm

(i) Plasterboards used for testing were Knauf Wallboard and British Gypsum Gyproc Wallboard.

(ii) Plasterboards used for testing were Knauf Soundshield Plus and British Gypsum Gyproc Soundbloc.

For other build-ups and further information, contact our Technical Support Team

# ACOUSTIC ROLL



**NON-COMBUSTIBLE  
INSULATION**



## ACOUSTIC ROLL (READY-CUT)

Thickness (mm)	Length (m)	Width (mm)	Rolls per pack	Area per pack (m <sup>2</sup> )	Rolls per pallet	Pallet product code
100	10.30	2x600	1	12.360	24	715843
100	10.30	3x400	1	12.360	24	715842
75	14.50	2x600	1	17.400	24	715841
63	15.00	2x600	2	18.000	24	603550
50	13.50	2x600	1	16.200	24	715837
25	11.10	4x600	4	26.640	24	715838

*All dimensions are nominal.*

## Building regulations compliant

Independent laboratory tested for proven use with major plasterboard brands.

- ✓ Knauf
- ✓ Siniat
- ✓ British Gypsum

Contact our Technical Support Team for details on  
01744 766 666 or [technical.uk@knaufinsulation.com](mailto:technical.uk@knaufinsulation.com)

### Building regulations

England and Wales: Approved Document E  
Northern Ireland: Technical Booklet G

All internal walls between a bedroom or room containing a WC and another room must provide a minimum sound insulation of 40 R<sub>w</sub> dB

### Building regulations

Scotland: Section 5

All internal walls between a bedroom or room containing a WC and another room must provide a minimum sound insulation of 43 R<sub>w</sub> dB

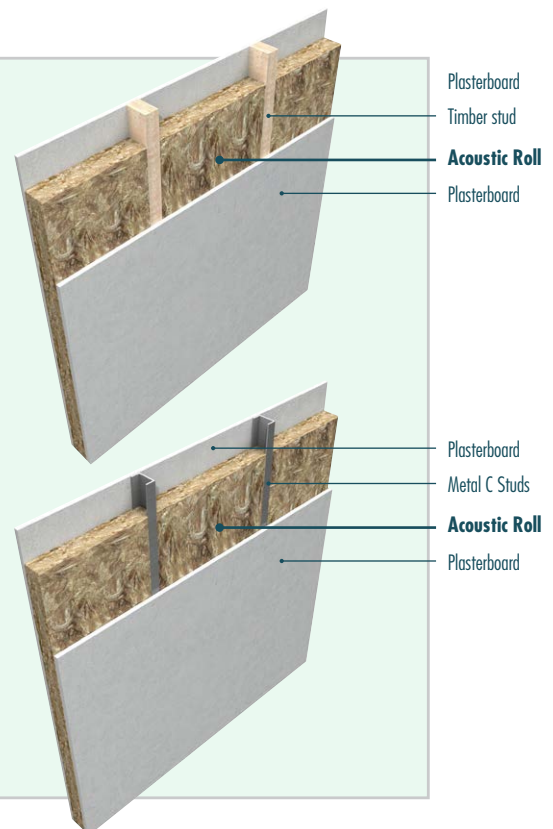



## APPLICATION OVERVIEW

Acoustic performance is the principle requirement for an internal floor, with both sound insulation and sound absorption being important considerations.

The sound absorption characteristics of our Mineral Wool insulation solutions make them ideal for use in internal floor build-ups.

We have a wide range of solutions which comply with sound related building regulations.

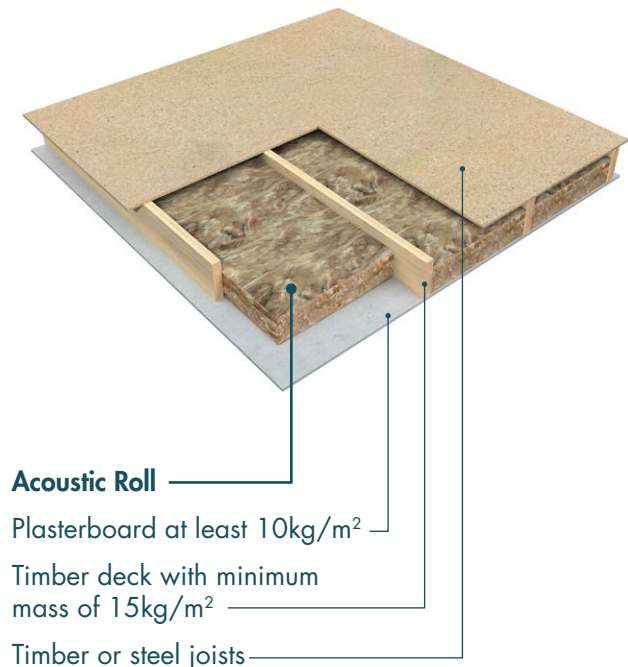

## RECOMMENDED PRODUCTS

- **Acoustic Roll** (see page 31)

## OTHER SUITABLE PRODUCTS

- **OmniFit® Roll 40** (see page 33)
- **OmniFit® Slab 35** (see page 35)
- **Rocksilk® Flexible Slab** (see page 41)
- **Rocksilk® RS45** (see page 42)

## INTERNAL FLOORS

		Required density	Product	Thickness
New build	Recommended	>10kg/m <sup>3</sup>	Acoustic Roll	100mm



# OMNIFIT® ROLLS



NON-COMBUSTIBLE  
INSULATION



## OMNIFIT® ROLL 40 (COMBI-CUT)

Thickness (mm)	Thermal conductivity (W/mK)	Thermal resistance (m <sup>2</sup> K/W)	Length (m)	Width (mm)	Area per pack (m <sup>2</sup> )	Rolls per pallet	Pallet product code
200	0.040	5.00	3.40	1200 (2x600 or 3x400)	4.080	40	474509
150	0.040	3.75	4.55	1200 (2x600 or 3x400)	5.460	40	474386
100	0.040	2.50	6.80	1200 (2x600 or 3x400)	8.160	40	474381

All dimensions are nominal

### PRODUCT ALSO SUITABLE FOR

- Pitched Roofs - Ceiling Level (see page 18)
- Internal Walls (see page 30)
- Internal Floors (see page 32)
- Suspended Timber Ground Floors (see page 34)

## OMNIFIT® ROLL 34 (UNCUT)

Thickness (mm)	Thermal conductivity (W/mK)	Thermal resistance (m <sup>2</sup> K/W)	Length (m)	Width (mm)	Area per pack (m <sup>2</sup> )	Rolls per pallet	Pallet product code
220*	0.034	6.45	2.50	1200	3.000	24	416121
180	0.034	5.25	3.00	1200	3.600	24	416113
150	0.034	4.40	3.50	1200	4.200	24	417800
140	0.034	4.10	4.20	1200	5.040	24	474996
100	0.034	2.90	5.20	1200	6.240	24	417796

All dimensions are nominal. \* Full loads only

### PRODUCT ALSO SUITABLE FOR

- Pitched Roofs - Rafter Level (see page 20)
- Timber Frame Walls - Built In (see page 26)
- Rainsreen Façade System (see page 36)





## APPLICATION OVERVIEW

In a suspended timber ground floor, insulation is placed between the joists and supported on netting (e.g. polypropylene) or timber battens.

In this application, an important consideration is the thermal and acoustic performance of the insulation.

Our Mineral Wool insulation solutions for suspended timber ground floors ensure that the product used fills all gaps between joists to prevent air movement which can lead to unwanted heat loss.

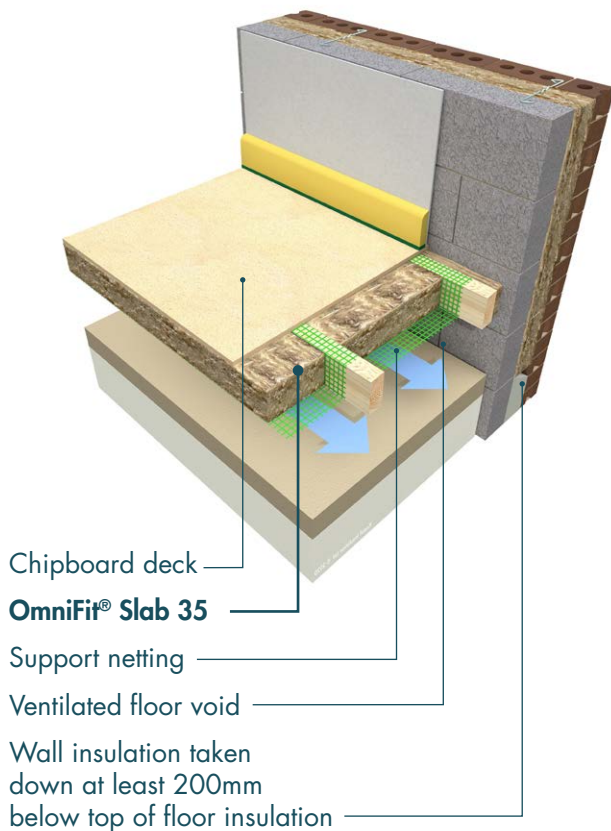

Chipboard deck  
**OmniFit® Slab 35**  
 Support netting  
 Ventilated floor void  
 Wall insulation taken down at least 200mm below top of floor insulation

## RECOMMENDED PRODUCTS

(installed from below)

- **OmniFit® Slab 35** (see page 35)
- **Rocksilk® Flexible Slab** (see page 41)

(installed from above)

- **OmniFit® Roll 40** (see page 33)

## OTHER SUITABLE PRODUCTS

- **Rocksilk® RS45** (see page 42)
- **OmniFit® Roll 34** (see page 33)

## SUSPENDED TIMBER GROUND FLOORS

	U-value (W/m <sup>2</sup> K)	Product	Thickness
Existing floors renovated elements	≤0.25	OmniFit® Slab 35	100mm
Extensions	≤0.22	OmniFit® Slab 35	140mm

# OMNIFIT® SLAB 35



**NON-COMBUSTIBLE  
INSULATION**



## OMNIFIT® SLAB 35 (600MM WIDE)

Thickness (mm)	Thermal conductivity (W/mK)	Thermal resistance (m <sup>2</sup> K/W)	Length (mm)	Width (mm)	Slabs per pack	Area per pack (m <sup>2</sup> )	Packs per pallet	Pallet product code
150	0.035	4.25	1200	600	4	2.880	32	587280
140	0.035	4.00	1200	600	4	2.880	36	474342
100	0.035	2.85	1200	600	6	4.320	32	474340
90	0.035	2.55	1200	600	6	4.320	36	474337
75	0.035	2.10	1200	600	8	5.760	32	587268
70	0.035	2.00	1200	600	8	5.760	32	474334
50	0.035	1.40	1200	600	12	8.640	24	474329

All dimensions are nominal.

## OMNIFIT® SLAB 35 (400MM WIDE)

Thickness (mm)	Thermal conductivity (W/mK)	Thermal resistance (m <sup>2</sup> K/W)	Length (mm)	Width (mm)	Slabs per pack	Area per pack (m <sup>2</sup> )	Packs per pallet	Pallet product code
140	0.035	4.00	1200	400	4	1.920	48	474318
100	0.035	2.85	1200	400	6	2.880	42	474314
50	0.035	1.40	1200	400	12	5.760	36	474293

All dimensions are nominal.

### PRODUCT ALSO SUITABLE FOR

- Pitched Roofs - Rafter Level (see page 20)
- Timber Frame Walls - Built In (see page 26)
- Internal Walls (see page 30)
- Rainsreen Façade System (see page 36)
- Internal Floors (see page 32)



Generic BRE Green Guide Rating **A+**



Declare.



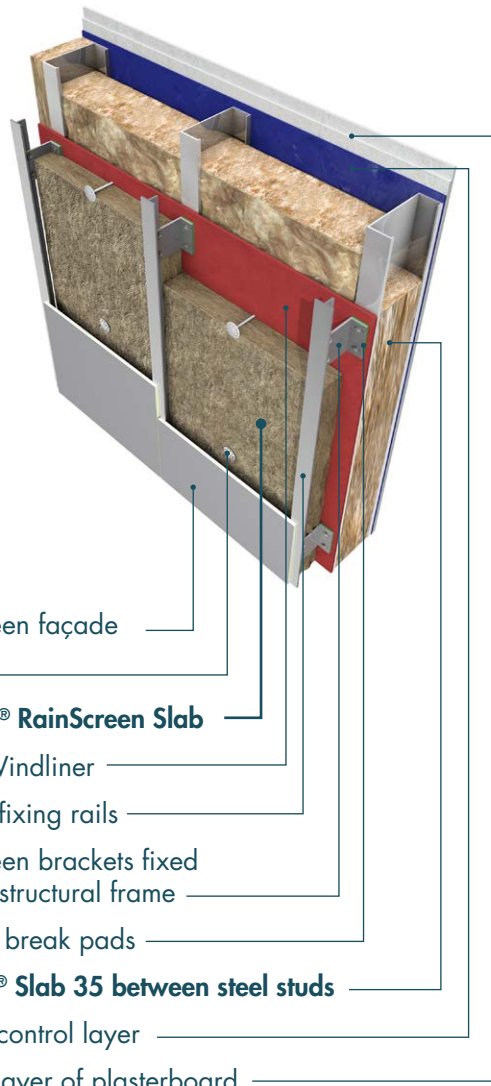

Rainscreen façade

Fixings

**Rocksilk® RainScreen Slab**

Knauf Windliner

Vertical fixing rails

Rainscreen brackets fixed  
back to structural frame

Thermal break pads

**OmniFit® Slab 35 between steel studs**

Vapour control layer

Double layer of plasterboard



## APPLICATION OVERVIEW

Rainscreen Façade Systems are lightweight when compared to brick and masonry solutions and can provide the designer with a wide range of aesthetic options.

In addition to thermal performance, fire performance of insulation materials is a crucial consideration, particularly when designing buildings in accordance with Building Regulations or when the building is to have high occupancy levels or be used by vulnerable occupants.

Our Rocksilk® RainScreen Slab can offer excellent thermal and acoustic performance, as well as being non-combustible, and can be installed on buildings over 18m.

## RECOMMENDED PRODUCTS (IN EXTERNAL RAINSCREEN ZONE)

- **Rocksilk® RainScreen Slabs** (see page 37)

## OTHER SUITABLE PRODUCTS (BETWEEN LIGHT STEEL FRAME STUDWORK)

- **OmniFit® Slab 35** (see page 35)
- **OmniFit® Roll 34** (see page 33)
- **Rocksilk® Building Slabs** (see page 42)
- **Rocksilk® Flexible Slab** (see page 41)

For more information on our Rocksilk® RainScreen Slab range please visit [knaufinsulation.co.uk/products/rocksilk-rainscreen-slab](http://knaufinsulation.co.uk/products/rocksilk-rainscreen-slab)

# ROCKSILK® RAINSCREEN SLABS

FOR RAINSCREEN FAÇADE SYSTEMS



**NON-COMBUSTIBLE  
INSULATION**



\*excludes BGV

## ROCKSILK® RAINSCREEN SLABS

Thickness (mm)	Thermal conductivity (W/mK)	Thermal resistance (m <sup>2</sup> K/W)	Length (mm)	Width (mm)	Pieces per pack	Packs per pallet	Area per pack (m <sup>2</sup> )	Area per pallet (m <sup>2</sup> )	MOQ (pallets)	Pallet product code
250	0.034	7.35	1200	600	2	10	1.440	14.40	16	656411
240	0.034	7.05	1200	600	2	10	1.440	14.40	16	656410
230	0.034	6.75	1200	600	2	12	1.440	17.28	14	656409
220	0.034	6.45	1200	600	2	12	1.440	17.28	15	656408
210	0.034	6.15	1200	600	2	12	1.440	17.28	1	640933
200	0.034	5.85	1200	600	2	12	1.440	17.28	1	640930
190	0.034	5.55	1200	600	2	12	1.440	17.28	17	652477
180	0.034	5.25	1200	600	3	10	2.160	21.60	1	640927
170	0.034	5.00	1200	600	3	10	2.160	21.60	15	651506
165	0.034	4.85	1200	600	3	10	2.160	21.60	16	658742
160	0.034	4.70	1200	600	3	10	2.160	21.60	16	651512
155	0.034	4.55	1200	600	3	12	2.160	25.92	14	658741
150	0.034	4.40	1200	600	3	12	2.160	25.92	1	640921
140	0.034	4.10	1200	600	3	12	2.160	25.92	15	651513
130	0.034	3.80	1200	600	3	12	2.160	25.92	17	651499
125	0.034	3.65	1200	600	4	10	2.880	28.80	2	658740
120	0.034	3.50	1200	600	4	10	2.880	28.80	1	640916
110	0.034	3.20	1200	600	4	12	2.880	34.56	15	650811
100	0.034	2.90	1200	600	4	12	2.880	34.56	1	640914
90	0.034	2.60	1200	600	5	12	3.600	43.20	15	650810
80	0.034	2.35	1200	600	5	12	3.600	43.20	16	650809
75	0.034	2.2	1200	600	6	12	4.320	51.84	1	640911
70	0.034	2.05	1200	600	6	12	4.320	51.84	15	650808
60	0.034	1.75	1200	600	7	12	5.040	60.48	15	650807
50	0.034	1.45	1200	600	8	12	5.760	69.12	1	640909
150 BGV*	0.034	4.40	1200	600	3	12	2.160	25.92	1	640959
120 BGV*	0.034	3.50	1200	600	4	10	2.880	28.80	1	640949
100 BGV*	0.034	2.90	1200	600	4	12	2.880	34.56	1	640935

Standard thickness. All dimensions are nominal. \* Black Glass Veil facing.



Generic BRE Green Guide Rating **A+**



Declare.





Wall insulation taken down at least 300mm below top of soffit insulation

**Rocksilk® Soffit Linerboard Standard**

Concrete slab

Floor screed

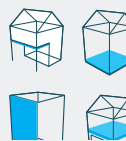

## APPLICATION OVERVIEW

If insulating below a structural floor, insulation can be fixed from below, allowing the floor to be insulated and finished in one process.

In timber frame exposed soffits, insulation is friction-fitted between timber joists, using the whole depth of the joist as an insulation zone. This allows high levels of thermal and acoustic insulation performance.

Our Rock Mineral Wool insulation solutions not only provide thermal and acoustic performance that would be required in an exposed soffit, but are also non-combustible giving additional peace of mind.

## RECOMMENDED PRODUCT

- **Rocksilk® Soffit Linerboard Standard** (see page 39)
- **Rocksilk® Soffit Linerboard Extra** (see page 39)

For more information on our Rocksilk® Soffit Linerboards range please visit [knaufinsulation.co.uk/products/rock-mineral-wool/soffit-linerboards](https://knaufinsulation.co.uk/products/rock-mineral-wool/soffit-linerboards)

# ROCKSILK® SOFFIT LINERBOARDS FOR EXPOSED SOFFIT FLOORS

Rocksilk® Soffit  
Linerboard Standard



**NON-COMBUSTIBLE  
INSULATION**

## ROCKSILK® SOFFIT LINERBOARD STANDARD

Thickness (mm)	Thermal conductivity (W/mK)	Thermal resistance (m <sup>2</sup> K/W)	Length (mm)	Width (mm)	Slabs per pallet	Area per pallet (m <sup>2</sup> )	Pallet product code
220	0.034	6.45	1200	600	20	14.400	469973
185	0.034	5.40	1200	600	28	20.160	672812
160	0.034	4.70	1200	600	28	20.160	2411455
130	0.034	3.70	1200	600	36	25.920	2411454

## ROCKSILK® SOFFIT LINERBOARD EXTRA

Thickness (mm)	Thermal conductivity (W/mK)	Thermal resistance (m <sup>2</sup> K/W)	Length (mm)	Width (mm)	Slabs per pallet	Area per pallet (m <sup>2</sup> )	Pallet product code
220/6*	0.034 / 0.24	6.55	1200	600	10	7.200	682465
185/6*	0.034 / 0.24	5.55	1200	600	12	8.640	682466
160/6*	0.034 / 0.24	4.75	1200	600	14	10.080	2411647
130/6*	0.034 / 0.24	3.75	1200	600	18	12.960	2411648

All dimensions are nominal. \*Thickness of facing board.

### Bespoke Sizes

Rocksilk® Soffit Linerboard is available in bespoke dimensions to suit specific thermal and aesthetic requirements in thicknesses from 50 to 270mm.



Generic BRE Green Guide Rating **A+**



Declare.



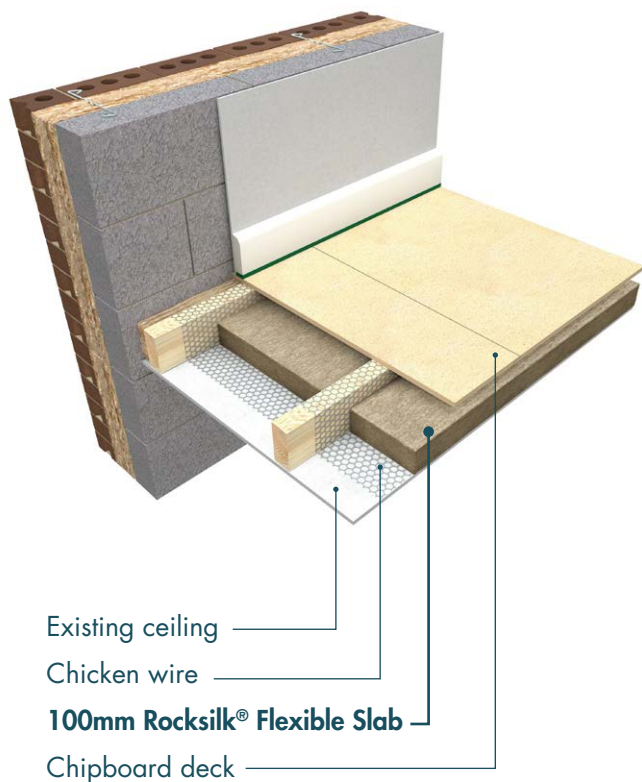

## UPGRADE OF TIMBER LOFT CONVERSION INTERNAL FLOORS

When the loft of a two-storey house is converted into habitable accommodation, the floor to the new rooms must have 30 minutes fire resistance over any part of the escape route directly below. This can be achieved by completely refreshing the ceiling or by retaining the existing ceiling and insulating the joists with insulation that achieves the fire resistance period.

For this reason, fire performance of an insulation solution in this application is a crucial consideration, as the insulation must provide its own fire resistance period if the existing ceiling is to be retained.

Our RocksilK® Flexible Slab is tested to meet the required fire resistance period as well as providing excellent acoustic properties in this application.

**RocksilK® Flexible Slab is tested to provide 60 minutes fire resistance in loft conversion floors at both 400mm and 600mm joist centres.**



# ROCKSILK® FLEXIBLE SLAB



**NON-COMBUSTIBLE  
INSULATION**



## ROCKSILK® FLEXIBLE SLAB

Thickness (mm)	Thermal conductivity (W/mK)	Thermal resistance (m <sup>2</sup> K/W)	Length (mm)	Width (mm)	Pieces per pack	Area per pack (m <sup>2</sup> )	Packs per pallet	Pallet product code
140	0.035	4.00	1200	600	3	2.160	12	2411335
100	0.037	2.70	1200	600	6	4.320	12	457994
90	0.037	2.40	1200	600	6	4.320	12	457997
70	0.037	1.85	1200	600	8	5.760	12	2411408
60	0.037	1.60	1200	600	10	7.200	12	457996
50	0.037	1.35	1200	600	12	8.640	12	457995
40	0.037	1.05	1200	600	14	10.080	12	531594

*All dimensions are nominal.*

## PRODUCT ALSO SUITABLE FOR

- Pitched Roofs - Rafter Level (see page 20)
- Timber Frame Walls (see page 26)
- Rainscreen Façade System (see page 36)
- Internal Walls (see page 30)
- Suspended Timber Ground Floors (see page 34)



Generic BRE Green Guide Rating **A+**



Declare.



# ROCKSILK® BUILDING SLABS



## PRODUCT SUITABLE FOR

- Pitched Roofs - Rafter Level (see page 20)
- Timber Frame Walls (see page 26)
- Internal Walls (see page 30)
- Suspended Timber Ground Floors (see page 34)

Thickness (mm)	Thermal conductivity (W/mK)	Thermal resistance (m <sup>2</sup> K/W)	Length (mm)	Width (mm)	Pieces per pack	Area per pack (m <sup>2</sup> )	Packs per pallet	Pallet product code
<b>ROCKSILK® RS45</b>								
150	0.035	4.25	1200	600	3	2.160	12	531096
100	0.035	2.85	1200	600	5	3.600	12	2411339
75	0.035	2.10	1200	600	6	4.320	12	2411328
60	0.035	1.70	1200	600	8	5.760	12	2411425
50	0.035	1.40	1200	600	10	7.200	12	2411327
40	0.035	1.10	1200	600	12	8.640	12	2411326
30	0.035	0.85	1200	600	16	11.520	12	2411424
25	0.035	0.70	1200	600	20	14.400	12	2411325
<b>ROCKSILK® RS60</b>								
100	0.034	2.90	1200	600	4	2.880	12	2411331
75	0.034	2.20	1200	600	6	4.320	12	2411330
60	0.034	1.75	1200	600	7	5.040	12	2411433
50	0.034	1.45	1200	600	9	6.480	12	2411329
40	0.034	1.15	1200	600	12	8.640	12	2411432
25	0.034	0.70	1200	600	18	12.960	12	2411430
<b>ROCKSILK® RS80</b>								
100	0.034	2.90	1200	600	3	2.160	16	2411332
75	0.034	2.20	1200	600	4	2.880	16	2411437
50	0.034	1.45	1200	600	6	4.320	16	2411435
<b>ROCKSILK® RS100</b>								
100	0.034	2.90	1200	600	3	2.160	16	2411334
75	0.034	2.20	1200	600	4	2.880	16	2411333
50	0.034	1.45	1200	600	6	4.320	16	2411441
40	0.034	1.15	1200	600	7	5.040	16	2411440
30	0.034	0.85	1200	600	10	7.200	16	2411439
25	0.034	0.70	1200	600	12	8.640	16	2411438
<b>ROCKSILK® RS100 WHITE TISSUE FACING 1</b>								
30	0.034	0.85	1200	600	10	7.200	16	528143

All dimensions are nominal.



## INTRODUCING ROCKSILK®

THE NEW BRAND FOR OUR ROCK MINERAL WOOL RANGE



**The same high quality products, under a new brand, with a fresh new look**

- Non-combustible insulation
- Made with ECOSE® Technology
- Thermal and Acoustic Performance

For more information on our Rock Mineral Wool range visit

[knaufinsulation.co.uk/rock-mineral-wool-insulation](http://knaufinsulation.co.uk/rock-mineral-wool-insulation)

# PRODUCT COMPARISON CHART

## Glass Mineral Wool

KNAUF INSULATION		ISOVER	SUPERGLASS	URSA	MAIN APPLICATIONS
<b>LOFT ROLLS</b>	Loft Roll 44 (Combi-cut) •	Spacesaver	Multi Roll 44	Ursa 10	<b>PITCHED ROOFS</b>
	Loft Roll 44 (Combi-cut/ Shorter Length) •	Spacesaver Lite	Handy Pack 44	-	
	Loft Roll 44 (Ready-cut) •	Spacesaver Ready-Cut	-	-	
	Loft Roll 40 (Combi-cut) •	Spacesaver Plus	Multi Roll 40	Ursa 20 Diverso	
<b>RAFTER ROLL</b>	Rafter Roll 32 •	Metac	Timber & Rafter Roll 32	Hometec Roll 32	<b>PITCHED ROOFS</b>
<b>FRAMETHERM® ROLL</b>	FrameTherm® Roll 40 (Ready-cut) •	Timber Frame Roll 40	Timber and Rafter Roll 40	-	<b>TIMBER FRAME WALLS</b> <b>PITCHED ROOFS</b>
	FrameTherm® Roll 35 (Ready-cut) •	Timber Frame Roll 35	Timber and Rafter Roll 35	Timber Frame Roll	
	FrameTherm® Roll 32 (Ready-cut) •	Timber Frame Roll 32	Timber and Rafter Roll 32	Timber Frame Roll 32	
<b>ACOUSTIC ROLL</b>	Acoustic Roll (Ready-cut) •	Acoustic Partition Roll	Acoustic Partition Roll	Acoustic Roll	<b>INTERNAL WALLS</b> <b>INTERNAL FLOORS</b> <b>SEPARATING FLOORS</b>
		Sound Deadening Floor Slab	Multi Acoustic Roll	-	
		RD Acoustic Floor Slab	Multi Purpose Acoustic Slab	-	
		RD 35	-	-	
<b>MASONRY PARTY WALL SLAB</b>	Masonry Party Wall Slab •	RD Party Wall Roll	Party Wall Roll	Party Wall Roll	<b>PARTY WALLS</b>
<b>TIMBER FRAME PARTY WALL SLAB</b>	Timber Frame Party Wall Slab •	-	Timber Frame Party Wall Slab	-	
<b>DRITHERM® CAVITY SLAB</b>	DriTherm® Cavity Slab 37 • DriTherm® Cavity Slab 34 • DriTherm® Cavity Slab 32 •	CWS 36	Superwall 36	-	<b>MASONRY CAVITY WALLS</b>
		CWS 34	Superwall 34	Cavity Batt 35	
		CWS 32	Superwall 32	Cavity Batt 32	
<b>FRAMETHERM® SLABS</b>	FrameTherm® Slab 32 •	-	Timber and Rafter Batt 40	-	<b>TIMBER FRAME WALLS</b> <b>PITCHED ROOFS</b>
		Timber Frame Batt 35	Timber and Rafter Batt 35	Timber Frame Slab 35	
		Timber Frame Batt 32	Timber and Rafter Batt 32	Timber Frame Slab 32	
		Low E Frame Batt	-	-	
<b>OMNIFIT®</b>	OmniFit® Roll 40 (Combi-cut) • OmniFit® Roll 34 (Uncut) • OmniFit® Slab 35 •	UniSlab	Multi Purpose Acoustic Slab	-	<b>MULTI APPLICATION</b>
		Metac	-	-	
		-	-	-	

The above is an interpretation only and is not intended to constitute recommendation for any products other than those offered by Knauf Insulation. Any third party wishing to use this information is advised to obtain further advice from the appropriate manufacturer of the product listed.

Details above are correct at time of print July 2021

• PRODUCTS MADE with **ECOSE™** TECHNOLOGY



Loft Roll 44



Loft Roll 40



Rafter Roll 32



FrameTherm® Roll 40



FrameTherm® Roll 35



FrameTherm® Roll 32



Acoustic Roll



FrameTherm® Slab 32



Masonry Party Wall Slab



Timber Frame Party Wall Slab



DriTherm® Cavity Slab 37



DriTherm® Cavity Slab 34



DriTherm® Cavity Slab 32



OmniFit® Roll 40



OmniFit® Roll 34



OmniFit® Slab 35

# Rock Mineral Wool

KNAUF INSULATION	ISOVER	SUPERGLASS	ROCKWOOL	MAIN APPLICATIONS
<b>GENERAL APPLICATION</b>				
Rocksilk® RS45 •	-	-	RWA45	PITCHED ROOFS RAFTER LEVEL
Rocksilk® RS60 •	-	-	RW3	INTERNAL FLOORS
Rocksilk® RS80 •	-	-	RW4	PARTITIONS
Rocksilk® RS100 •	-	-	RW5	PROLIGHT STEEL FRAME WALLS
				SUSPENDED TIMBER GROUND FLOOR FABRICATION
Rocksilk® Flexible Slab •	-	-	Flexi Slab	SEPARATING WALLS & PARTITIONS
			Thermal Slab	FLOORS
			Sound Slab	PITCHED ROOFS RAFTER LEVEL
				ONE HOUR FLOOR UPGRADE
<b>FLOOR SLABS</b>				
Rocksilk® Soffit Linerboard •	-	-	Soffit Slab	
Rocksilk® Soffit Linerboard Extra •	-	-	Soffit Slab	EXPOSED SOFFIT
<b>EXTERNAL WALLS</b>				
Rocksilk® RainScreen Slab •	Polterm Max Plus	-	DuoSlab	RAINSCREEN FACADES
Rocksilk® RainScreen Slab BGV •	-	-	DuoSlab BTF	

• PRODUCTS MADE with **ECOSE** TECHNOLOGY



Rocksilk® RS45



Rocksilk® RS60



Rocksilk® RS80



Rocksilk® RS100



Rocksilk® Flexible Slab



Rocksilk® Soffit Linerboard Standard



Rocksilk® Soffit Linerboard Extra



Rocksilk® RainScreen Slab



# KNAUF INSULATION

## PIR substitution chart

The table below shows DriTherm® Cavity Slab 32 thicknesses required to achieve the same or better U-value as PIR partial fill cavity insulation for different types of blocks.

BLOCK TYPE	INSULATION	U-VALUE REQUIRED (W/m²K)									
		0.28	0.25	0.23	0.22	0.21	0.20	0.19	0.18		
See reverse for blocks	Thermal Conductivity (W/mK)	Thickness (mm)									
Lightweight Aircrete	PIR 0.021	50	50	50	75	75	75	75	75		
	PIR 0.022	50	50	75	75	75	75	75	85		
	<b>DriTherm® Cavity Slab 32</b>	<b>75*</b>	<b>100</b>	<b>100</b>	<b>125</b>	<b>125</b>	<b>125</b>	<b>150</b>	<b>150</b>		
Standard Aircrete	PIR 0.021	50	50	75	75	75	75	75	85		
	PIR 0.022	50	50	75	75	75	75	85	85		
	<b>DriTherm® Cavity Slab 32</b>	<b>85*</b>	<b>100</b>	<b>125</b>	<b>125</b>	<b>125</b>	<b>125</b>	<b>150</b>	<b>150</b>		
Ultra Lightweight Aggregate	PIR 0.021	50	75	75	75	75	75	85	85		
	PIR 0.022	50	75	75	75	75	75	85	85		
	<b>DriTherm® Cavity Slab 32</b>	<b>85*</b>	<b>100</b>	<b>125</b>	<b>125</b>	<b>125</b>	<b>150</b>	<b>150</b>	<b>150</b>		
Lightweight Aggregate	PIR 0.021	50	75	75	75	75	75	85	85		
	PIR 0.022	50	75	75	75	75	85	85	100		
	<b>DriTherm® Cavity Slab 32</b>	<b>100</b>	<b>125</b>	<b>125</b>	<b>125</b>	<b>150</b>	<b>150</b>	<b>150</b>	<b>150</b>		
Medium Dense	PIR 0.021	50	75	75	75	75	85	85	100		
	PIR 0.022	50	75	75	75	75	85	85	100		
	<b>DriTherm® Cavity Slab 32</b>	<b>100</b>	<b>125</b>	<b>125</b>	<b>125</b>	<b>150</b>	<b>150</b>	<b>150</b>	<b>160**</b>		
Dense	PIR 0.021	50	75	75	75	75	85	85	100		
	PIR 0.022	50	75	75	75	75	85	100	100		
	<b>DriTherm® Cavity Slab 32</b>	<b>100</b>	<b>125</b>	<b>125</b>	<b>125</b>	<b>150</b>	<b>150</b>	<b>150</b>	<b>160**</b>		
		<b>Extensions in England</b>								<b>Extensions in Wales</b>	

\* The stated U-value can be achieved with this thickness in a smaller cavity than necessary for the PIR Solution. Either reduce the cavity width to the DriTherm® 32 thickness or use 100mm DriTherm® 32.

\*\* 85mm+75mm required to achieve thickness

**Simply substitute the 0.022 W/mK PIR partial fill for full fill DriTherm® Cavity Slab 32**

Thickness required is greater than the required cavity for PIR (0.022 W/mK) in this case either consider widening the cavity or call **Knauf Insulation Technical Support Team for advice on 01744 766666 or email [technical.uk@knaufinsulation.com](mailto:technical.uk@knaufinsulation.com)**

**Calculation method:** The U-values have been calculated assuming that all walls are lined with 12.50mm standard plasterboard on dabs on standard blocks with 10mm mortar joints. Wall ties assumed to be stainless steel at 2.5 per m² with a cross-sectional area of no more than 12.5mm² for structural cavities up to 100mm wide and no more than 24mm² for cavities over 100mm wide. Emissivity of foil facing for partial fill solutions assumed to be 0.05 and airspace resistance calculated accordingly.

## Block types and PIR brands

LIGHTWEIGHT AIRCRETE		≤0.11 W/mK
Manufacturer	Block	Compressive Strength (N/mm <sup>2</sup> )
Forterra (Hanson)	Thermalite Turbo	2.9
H+H (Celcon)	Solar Grade	2.9
Tarmac	Toplite GTI	2.9
Tarmac	Durox Supabloc	3.6
Thomas Armstrong	Airtec XL	2.9
Thomas Armstrong	Airtec Standard	3.6

STANDARD AIRCRETE		≤0.16 W/mK
Forterra (Hanson)	Thermalite Shield	3.6
H+H (Celcon)	Standard Grade	3.6
Quinn Lite	Super Blocks	2.9
Tarmac	Toplite Standard	3.6

ULTRA LIGHTWEIGHT AGGREGATE AND HIGH STRENGTH AIRCRETE		≤0.24 W/mK
Forterra (Hanson)	Thermalite HiStrength 7	7.3
Forterra (Hanson)	Thermalite Hi Strength 10	9
H+H (Celcon)	High Strength	7.3
H+H (Celcon)	Super Strength	8.7
Interfuse	Optilyte	3.6
Interfuse	Interyte Ultra	3.6
Plasmor	Fibolite	3.6
Quinn Lite	Standard Blocks	5.2
Quinn Lite	Seven Blocks	7.5
Skene	GlenSupaLite	7.3
Tarmac	Toplite 7	7.3
Tarmac	Durox Supabloc 4	4.2
Tarmac	Durox Supabloc 7	7.3
Tarmac	Durox Supabloc 8	8.7
Thomas Armstrong	Airtec Seven	7.3

LIGHTWEIGHT AGGREGATE		≤0.36 W/mK
Besblock	Pumice	7.0
Broome Bros	Extralite	3.6
CCP	Modulite Plus	4.2
Interfuse	Interyte Ultra	7.3
Lignacite	Fibo 850	3.6
Masterblock	Masterlite Ultra	3.6
Mona Precast	Fibotherm	3.6
Plasmor	Aglite Ultima	7.3
Plasmor	Aglite Ultima	10.4
Plasmor	Fibolite	7.3
Sellite	Ultralightweight	3.6
Sellite	Ultralightweight	7.3
Stowell	Fibotherm	3.6
Tarmac	Hemelite Ultralite	3.6
Thomas Armstrong	Ultralite	7.3
WD Lewis	Pumice	3.6

MEDIUM DENSE		≤0.51 W/mK
Besblock	Insulite	7
Broome Bros	Donlite 3.6	3.6
Broome Bros	Donlite 7.3	0.14
CCP	Modulite	7
Cemex	1400 Readyblock	7.3
Cemex	1100 Readyblock	3.6
Forterra (Hanson)	Fenlite	10.4
Forterra (Hanson)	Fenlite 1500	10.4
Glendenning	SC Solid Lightweight	7.3
Interfuse	Interyte	2.9
Interfuse	Interyte	3.6
Interfuse	Interyte	7.3
Laird Bros	Pummalite	7.3
Lignacite	Houseblock 1100	3.6
Lignacite	Ashlite	10.4
Mona Precast	Monalight 100s	7.6
Newlay	Newlite	7.3
Plasmor	Stranlite	7.3
Plasmor	Stranlite	10.4
Sellite	Thermal	10.4
Skene	GlenEcoLite	10.4
Skene	GlenTherm	10.4
Tarmac	Hemelite Std	3.6
Tarmac	Hemelite Std	7.3
Tarmac	Hemelite Std	10.4
Thakenham	Teklite	7.3
Thomas Armstrong	Insulite	7.3
WD Lewis	Medium Dense 3.6	3.6
WD Lewis	Medium Dense 7.3	7.3
WD Lewis	Medium Dense 10.3	10.3

DENSE		≤1.13 W/mK
Besblock	Bescrete	21
CCP	Consolite	21
Glendenning	SC Solid	10.4
Hillhouse Quarry group	Carrickcrete 7.3	7.3
Hillhouse Quarry group	Carrickcrete 10.4	10.4
Laird Bros	Lunacrete	22.5
Lignacite	Lignacite Medium GP /SP	10.4
Lignacite	Lignacite Medium Standard	10.4
Masterblock	Masterlite Pro	10.4
Masterblock	Masterdenz	22.5
Newlay	Newcon	22.5
Patterson Quarries Ltd	Standard Dense 7.3	7.3
Patterson Quarries Ltd	Standard Dense 10.4	10.4
Patterson Quarries Ltd	Lightweight	7.3
S Morris	Dense Solid	22.5
S Morris	Med Dense Solid	7.3
Sellite	Standard Concrete	10.4
Stowell	Stowlite	7.3
Thomas Armstrong	Dense Solid	10.4
WD Lewis	Dense Aggregate	10.4

PIR Thermal Conductivity	PIR Brand				
0.022 W/mK	Celotex CW4000	Kingspan TW50	Xtratherm XT CW	Ecotherm Eco Cavity	Quintherm QW-Cavity Wall
0.021 W/mK	Celotex CW5000	Xtratherm XT CWP			

## THE BEST KEEPS GETTING BETTER

From **improved packaging** to a further **upgrade of our compression technology**, the latest changes we've made are designed to **make our market-leading, non-combustible insulation even better.**

**Better for you**, because it's easier to choose, use, store and handle your insulation.

**And better for the world**, because together, we're reducing our carbon footprint even further.



**Learn more about our enhanced range, and what it means for you:**

[knaufinsulation.co.uk/the-best-keeps-getting-better](https://knaufinsulation.co.uk/the-best-keeps-getting-better)  
or scan our QR code with your smartphone camera.





# OUR ACCREDITATIONS

We're proud to have gained a number of accreditations and be able to provide our customers the assurance that our products are manufactured to the highest level of quality, having passed a series of comprehensive and rigorous assessments which ensures they're fit for purpose.



## Euroclass reaction to fire classification

All of our products are non-combustible and achieve the best Euroclass A1 or A2-s1,d0 reaction to fire classification.



## BBA Certification

The British Board of Agrément offers third party certification for the use of building products and systems in critical applications. We have a number of products certified, and are always seeking to increase our portfolio.



## BES 6001

The BES6001 accreditation shows that our products have been made with constituent materials that have been responsibly sourced.



## ISO

All of our manufacturing plants are certified to ISO standards.



## BRE Green Guide Rating A+

We have received the BRE Green Guide Rating A+ for the best environmental performance for the majority of our products.



## EUCEB

An independent certification authority that guarantees our Mineral Wool products are made of certified bio-soluble fibres.



## CE Marking

All our products are CE marked where required.



## DECLARE 'Red List' Free

All of our glass mineral wool products and our unfaced rock mineral wool products made with ECOSE® Technology have been awarded the DECLARE 'Red List Free' label. This allows product transparency disclosure that identifies where a product comes from and what it is made of.



## Eurofins Indoor Air Comfort Gold Certified

The Eurofins Gold certification for Indoor Air Comfort means our Glass and Rock Mineral Wool products are the best-in-class low VOC emissions and are therefore the ideal solution for indoor air quality.



## Made in Britain

As a member of the Made in Britain organisation, it helps customers identify that our Mineral Wool products are manufactured in the UK.



## EN 15804

Our Environmental Product Declarations (EPD) are in line with the BRE and European standard EN 15804.

## Density

The degree of mass per unit volume of a substance.

## ECOSE® Technology

ECOSE® Technology is our unique bio-based binder, that is used in the manufacture of all of our Glass Mineral Wool products and the majority of our Rock Mineral Wool products, to bind insulation strands together.

ECOSE® Technology contains no added formaldehyde or phenol. It is made from natural raw materials that are rapidly renewable and is 70% less energy-intensive to manufacture than traditional binders, so it is more environmentally-friendly.

Products made with ECOSE® Technology are soft to touch and easy to handle. They generate low levels of dust and VOCs and have been awarded the Eurofins Gold Certificate for Indoor Air Comfort.

## Euroclass reaction to fire classification

The Euroclass system is a harmonised methodology for the classification of building products based on their reaction-to-fire performance. The system also defines the test methods according to which construction products shall be recognised. The purpose of harmonization is to facilitate the trade of building products between the member countries of the EU by removing trade barriers due to differences in test methods and classification systems. There are seven levels of classification, please refer to page 25 for more detail.

## Glass Mineral Wool

Our high performance Glass Mineral Wool insulation solutions contain up to 80% high quality recycled content, to which sand, limestone and soda ash is added before being melted in a furnace. The molten glass is spun to form millions of fine strands of wool.

To manufacture our Cured Glass Mineral Wool, we use our unique bio-based binder, ECOSE® Technology, to bind the mineral wool together to form a mat of material which is then cured in order to form the final product. The density of the product determines whether the insulation is a lightweight quilt supplied in rolls, a flexible slab or a rigid slab, and its thermal insulation value.

## Non-Combustible

Non-combustible means that the material will not ignite, burn or release flammable vapours when exposed to fire or heat.

## R-Value

A measure of how well a two-dimensional barrier, such as a layer of insulation, a window or a complete wall or ceiling, resists the conductive flow of heat.

## Rock Mineral Wool

Our rock mineral wool is manufactured using around 35% recycled content (recycled material mostly from the steel industry along with customer production waste). An increasing proportion is now recycled material from slag, a waste product from blast furnaces. The raw materials are melted and then spun into fine strands of wool. A binder is used to bind the wool together to form a mat of insulation, which is then cut into slabs or wired mattresses. Most of our Rock Mineral Wool products use our ECOSE® Technology.

## Robust Detail

Robust details provide an alternative to pre-completion testing for demonstrating compliance with the performance standards of Part E for new build dwellings.

## Sound Absorption

Sound energy converted into mechanical vibration energy and/or heat energy. Sound absorption is usually expressed as a sound absorption coefficient.

## Thermal Bridging

A thermal bridge (or cold bridge), is an area of a building which has a significantly higher heat transfer than the surrounding materials resulting in an overall reduction in thermal insulation of the object or building.

A thermal bridge describes a situation in a building where there is a direct connection between the inside and outside through one or more elements that are more thermally conductive than the rest of the building envelope.

## Thermal Conductivity

The rate at which heat is transmitted through a material, measured in watts per square metre of surface area for a temperature gradient of one Kelvin per metre thickness, simplified to W/mK.

## U-value

A measure of the rate of heat loss of a building component. It is expressed as watts per square metre, per degree Kelvin, W/m<sup>2</sup>K. The U-value is calculated from the reciprocal of the combined thermal resistances of the materials in the element, air spaces and surfaces, also taken into account is the effect of thermal bridges, air gaps and fixings.

## Vapour Control Layer (VCL)

A vapour control layer is a material that substantially reduces the water vapour transfer through a building element into which it is incorporated i.e. polythene sheet materials or foil backed plasterboard. Vapour control layers are sometimes required on the warm side of the insulation, to reduce the possible risk of interstitial condensation within the construction element.

## BOOK YOUR TRAINING TODAY!



**We have created six 10-15 minute online training presentations to help you provide the best service to your customers.**

**Our training sessions are made with you in mind and will be presented by a member of our dedicated team at a time that is good for you. The presentations available are:**

- Introduction to Insulation
- Introduction to Acoustics
- Introduction to Reaction to Fire
- Loft Insulation (Cold & Warm Roofs)
- Masonry Cavity Wall Insulation
- Timber Frame Wall Insulation

To book any of our training sessions please visit [knaufinsulation.co.uk/merchants](https://knaufinsulation.co.uk/merchants)

# KNAUFINSULATION

## CONTACTS

### Customer Service (sales)

01744 766 766

[sales.uk@knaufinsulation.com](mailto:sales.uk@knaufinsulation.com)

### Merchant Support Team

01744 766 866

[kimerchantsupport@knaufinsulation.com](mailto:kimerchantsupport@knaufinsulation.com)

### Technical Services Team

01744 766 666

[technical.uk@knaufinsulation.com](mailto:technical.uk@knaufinsulation.com)



**Knauf Insulation Ltd** PO Box 10, Stafford Road, St.Helens, Merseyside, WA10 3NS. UK

For more information please visit [knaufinsulation.co.uk](http://knaufinsulation.co.uk)

All rights reserved, including those of photomechanical reproduction and storage in electronic media. Extreme caution was observed when putting together and processing the information, text and illustrations in this document. Nevertheless, errors cannot be completely ruled out. The publisher and editors cannot assume legal responsibility or any liability for incorrect information and consequences thereof. The publisher and editors will be grateful for improvement suggestions and details of possible errors pointed out. For the most up-to-date document versions and product information, please always refer to our website.