

Ecophon Solo™ Pentagon

Solo Pentagon is a free-hanging unit, offering high level design possibilities. Three different suspension systems offer opportunities to create several layers and angles. Suitable when the room volume should be maintained or when it's not possible to install a wall-to-wall ceiling.



Ghalamco Arena, Belgium

SYSTEM RANGE



Size, mm	1139x1198
Special Fixing	•
Thickness	40
Inst. Diag.	M427

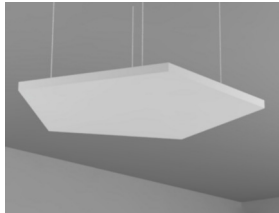

Acoustic panel Solo Freedom in cloud shape



Suspension with Connect Adjustable wire hanger and Connect Absorber anchor

Acoustic



The values in the diagram refer to a single unit. If the units are arranged in a cluster with distances between units less than 0,5 meters, the Aeq per unit will be slightly reduced.

Sound Absorption:

Based on test results according to EN ISO 354.

A_{eq} Equivalent absorption area per unit (m² sabin)

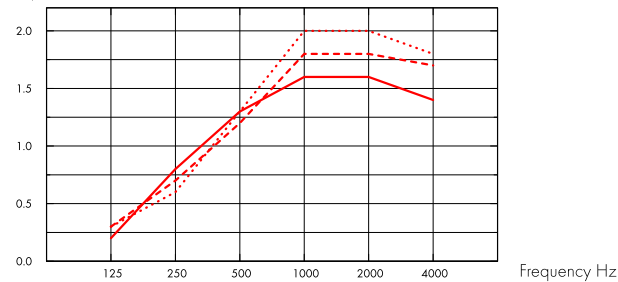

- Solo Pentagon 1139x1198, 200 mm o.d.s.
 - - - Solo Pentagon 1139x1198, 400 mm o.d.s.
 - ... Solo Pentagon 1139x1198, 1000 mm o.d.s.
- o.d.s. = overall depth of system

THK mm	o.d.s. mm	A_{eq} Equivalent absorption area per unit (m ² sabin)					
		125 Hz	250 Hz	500 Hz	1000 Hz	2000 Hz	4000 Hz
40	200	0.2	0.8	1.3	1.6	1.6	1.4
40	400	0.3	0.7	1.2	1.8	1.8	1.7
40	1000	0.3	0.6	1.3	2.0	2.0	1.8

Indoor Air Quality



Certificate / Label	Plant	
Eurofins Indoor Air Comfort®	IAC	IAC Gold
French VOC	A	A+
Finnish M1	•	•



Environmental Footprint



	kg CO ₂ equiv./m ²
Solo Freedom	8,41
Solo Freedom/Plant	5,21

Life-cycle stages A1 to C4 from EPD, in conformity with ISO 14025 / EN 15804

Circularity



Minimum post-consumer recycled content	57%
Recyclability	Fully recyclable



Fire safety

Country		Class
Europe	EN 13501-1	A2-s1,d0

The glass wool core of the tiles is tested and classified as non-combustible according to EN ISO 1182.



Humidity Resistance

Product	
Standard	Class C, RH 95% and 30°C
Plant	Class A, RH 70% and 25°C

According to EN 13964:2014



Visual appearance

White Frost, nearest NCS colour sample S 0500-N, 85% light reflectance. Gloss < 1.



Cleanability

Daily dusting and vacuum cleaning. Weekly wet wiping.



Accessibility

The tiles are demountable.



Installation

Installed according to installation diagrams, installation guides and drawing aid. For information regarding minimum overall depth of system see quantity specification.



Mechanical properties

The tile can take both point loads and distributed loads. See Functional demands, Mechanical properties at www.ecophon.com.



CE

Ecophon ceiling systems are CE marked according to the European harmonized standard EN 13964:2014. CE marked construction products are covered by a Declaration of Performance (DOP) which enables customers and users to easily compare performance of products available on the European market.

INSTALLATION DIAGRAM (M427) FOR ECOPHON SOLO PENTAGON

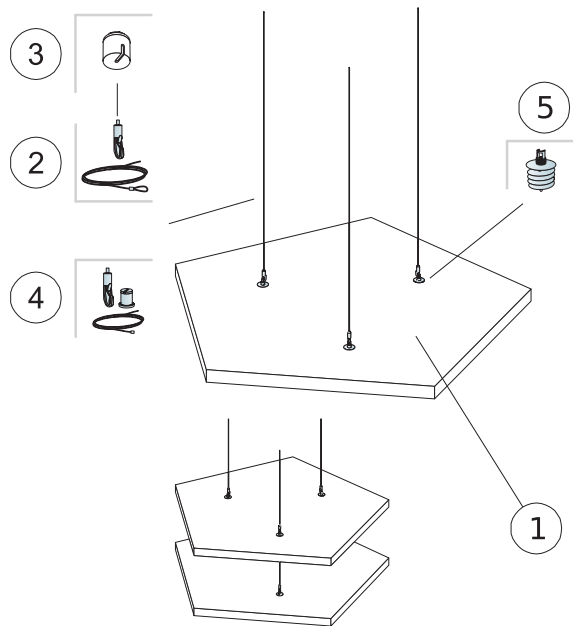

QUANTITY SPECIFICATION (EXCL. WASTAGE)

		Size, mm
		1139x1198
1	Solo Pentagon	0,94m ² /panel
2	Connect Adjustable wire hanger (Alt 1)	3/panel
3	Connect Covering cup (Alt 1, Optional)	3/panel
4	Connect Adjustable wire Kit (Alt 1, Optional)	3/panel
5	Connect Absorber anchor (Alt 1)	3/panel
Δ Min. overall depth of system: 140 mm		-
To install Connect Absorber Anchor, use Connect Absorber Anchor Bit.		-

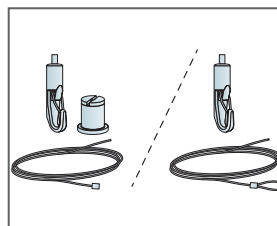
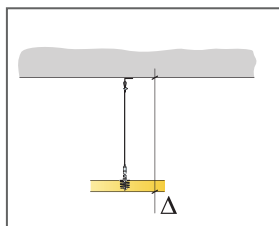

Two types of Adjustable wire solutions

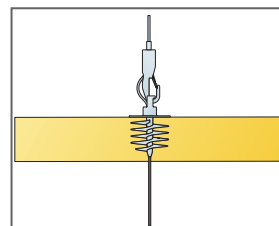

Panels can be suspended underneath each other

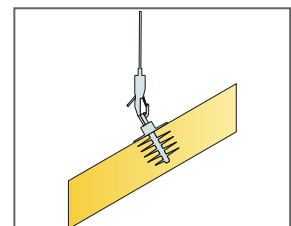

Panels can be installed in angles