

Marley's Roof Defence roll and ridge section are designed to provide fire resisting performance between separate properties.

Roof Defence forms a fire-resistant barrier below the roof and ridge tiles – and above the party walls or spandrel panels below the roof covering – which separate different properties within roof spaces or provide lines of compartmentation, typically in attached or terraced housing.

Roof Defence roll and ridge section is manufactured from low smoke zero halogen, highly intumescent flexible material.

GENERAL PREPARATION

- 1 Roof Defence Roll must be installed in a continuous band across the roof, following the party wall (compartmentation) line.

The correct positioning should be confirmed with the project designer or specifier.

- 2 Any joints that need to be formed between rolls must be overlapped (see step 2, page 6).

- 3 The party wall/spandrel panel/compartment wall should be constructed with the appropriate fire resistance rating required and the head of the wall should be completed in a flat plane in line with the timber truss/rafters either side of the wall.

- 4 Roof Defence Ridge must be installed in a continuous line across the ridge, following the party wall and or compartmentation line.

The correct positioning should be confirmed with the project designer or specifier.

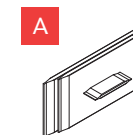

Roof Defence Ridge

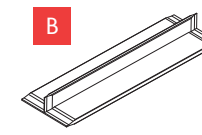

Roof Defence Roll

FIRE COMPARTMENT WALL/PARTY WALL LINE

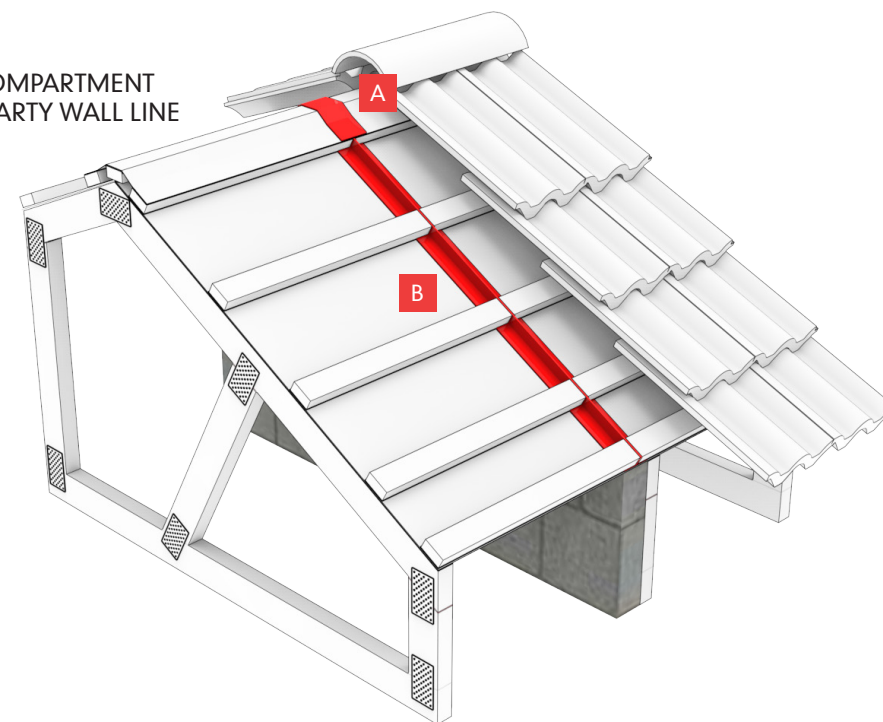

PRODUCT SPECIFICATION

DESCRIPTION

Each Roof Defence Roll, is 6.3m long x 100mm wide x 6mm thick with an upstand (forming an inverted T shape) 25mm high x 4mm thick. Suitable for maximum 96mm gaps between wall head (above the breather membrane) and the highest point of roof tile profile (to the underside of the tile).

Each Roof Defence Ridge, is formed with a T shaped profile, similar to the roll above, typically measuring 150mm long x 100mm wide x 4mm thick, or 50mm long x 25mm wide x 4mm thick, the ridge section is also provided with an additional flat section measuring 200mm long x 100mm wide by 4mm thick.

BEFORE ORDERING

Roof Defence Roll and Ridge section are designed to be used in conjunction with appropriately fire rated spandrel panels / masonry walls and non combustible roof tiles only.

The system selected should be confirmed as being approved with the persons responsible for design, for example the architect and or the fire engineer.

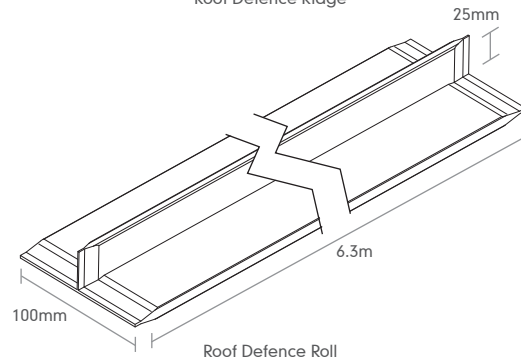
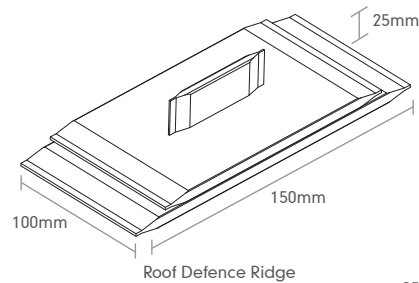

FIXINGS

FIXING TO TIMBER

Staples - When fixing directly into timber substrates with T50 staples, a minimum 12mm and maximum 14mm long stainless-steel staples should be used.

Screws - When fixing directly into timber substrates with screws stainless steel screws should be used, the diameter of the screw head should be a minimum of 10mm and a maximum width of 11.5mm, the length of the screw should be a minimum of 25mm.

Nails - Nail guns may be used, however the firing pressure should be careful controlled to ensure that the stainless steel nail, head minimum diameter 10mm and maximum 11.5mm does not push through the 6mm fire barrier, the nail should be a minimum of 25mm long.

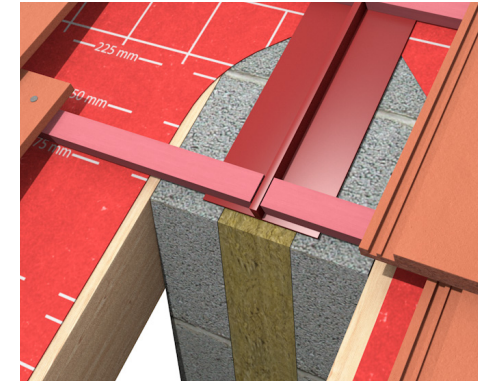

FIXING TO MASONRY

When fixing into masonry self-tapping stainless steel screws should be used, the diameter of the screw head should be a minimum of 10mm and a maximum width of 11.5mm, the length of the screw should be a minimum of 25mm.

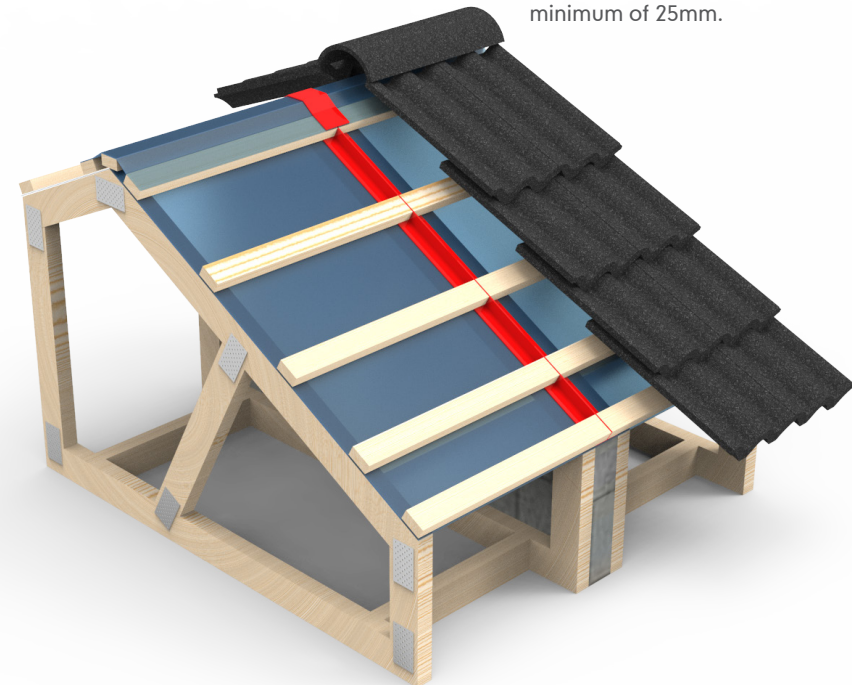

ROLL INSTALLATION

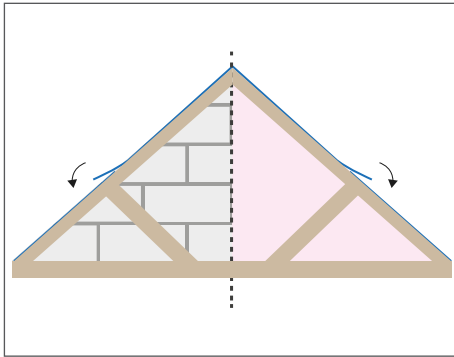

Fig. 1 – Follow plane of roof

- 1 Fix the breather membrane into position as required.

The top of the spandrel panel or brick/block wall should be completed in a flat plane in line with the top of the roof truss/rafters.

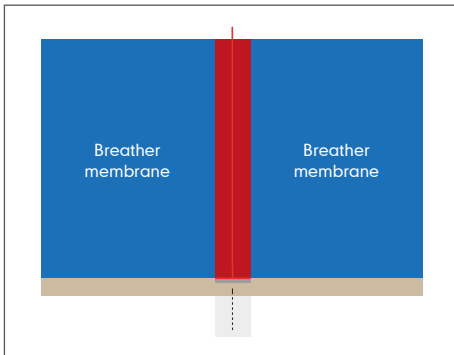

Fig. 2 – Place over breather membrane/underlay

- 2 The Roof Defence roll should be placed over the breather membrane, freely facing upwards, with the 100mm flat side positioned centrally on the centre line of the party/compartiment wall/spandrel panel (forming the line of compartmentation) separating the properties or compartments.

Any joints made must be overlapped by a minimum of 25mm so that the intumescent material is continuous across the roof compartmentation line. This can be achieved by cutting the plastic sleeve between the flat section and the inverted T upstand, taking care not to damage the intumescent strip.

Cut at least 25mm of the intersection of the plastic sleeve and fold the up stand back, overlap the flat section of the fire barrier with the adjoining section of fire barrier. Fold the inverted T section back into its central position and staple the upstands to each other.

The sleeve covering the fire barrier may be left open ended where it may have been cut to suit the installation.

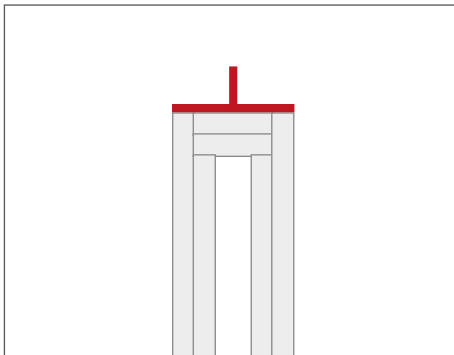

Fig. 3 – Roll positioned over party wall

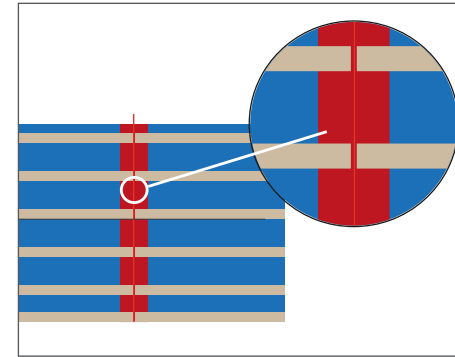

Fig. 4 – Roll sits between batten ends

- 3 The 25mm vertical upright of the fire barrier should stand upright and be positioned on the centre line between where the roof tile battens will be fixed, again on the centre line of the party wall/spandrel panel separating the line of compartmentation.

The Roof Defence Roll will sit between and beneath the roof tile battens.

Note: The Roof Defence fire barrier, should be installed in such a way that ensures the fire barrier is not interrupted, roof tile battens should not interrupt the fire barrier, roof tile battens must be cut either side of the fire barrier.

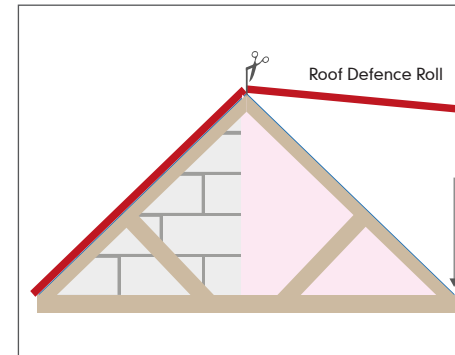

Fig. 5 – Cut roll at ridge apex

- 4 Where the Roof Defence Roll passes over the ridge the 25mm upstand will require cutting at the apex of the ridge to allow the roll to continue down the other side of the roof.

- 5 Roof Defence Ridge may be fixed permanently into position prior to the fixing of the roof tile battens, the barrier should as a minimum be fixed within 500mm of the ridge and 500mm from the lower edge of the roof, with a maximum of 1metre distance between all intermediate fixing points.

Fit and fix roof tile battens, either side of the fire barrier, as per required roof fixing details, all battens can be fixed through the ridge section if required.

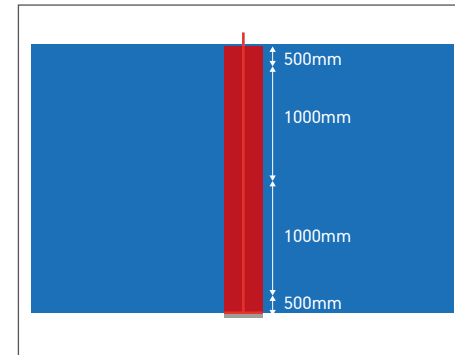

Fig. 6 – Fixing positions

- 6 Fit roof tiles as per required details, not ridge tiles (see page 8-9).

RIDGE INSTALLATION

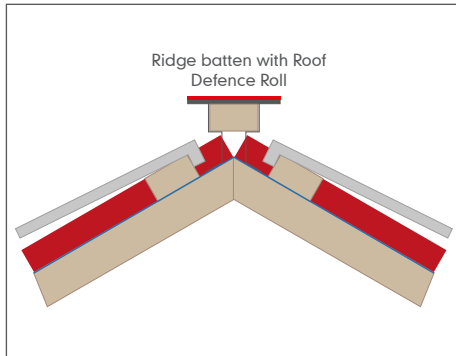

Fig. 7a – Position ridge section

- 7 Fit ridge timbers as per manufacturer's instructions ensuring that a 5mm gap is left between the ridge batten associated with the ridge details.

Alternatively, fit one side of the ridge timbers, to one side of the compartment line and attach the shorter part of the T (25mm by 4mm thick) section of the ridge cap to the end of the ridge timber, ensuring that the ridge cap is positioned centrally to the ridge batten. Fit the adjoining ridge batten as required.

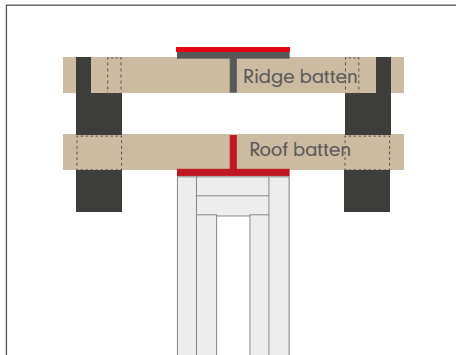

Fig. 7b – Ridge, side elevation

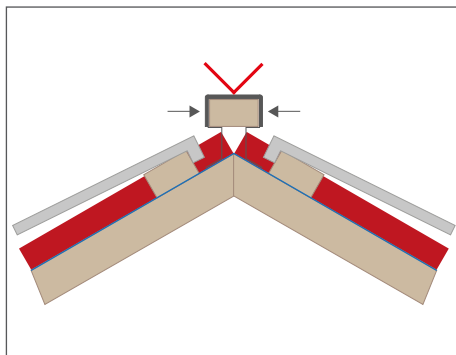

Fig. 8 – Wrap ridge section around ridge batten

- 8 Wrap the remaining part of the ridge section (100mm wide by 150 long by 4mm thick) down the sides of the ridge battens and fix to the ridge battens.

Ensure that the second flat layer of roll is freely moving, not fixed down to the ridge timbers or battens and is only fixed at the centre to the wide/flat part of the inverted T strip below, this should be as it was supplied.

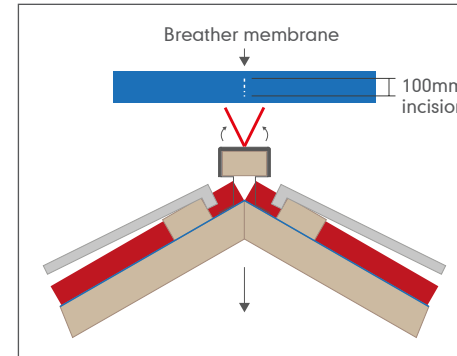

Fig. 9a – Position ridge section

- 9 Fit ventilated ridge kit breather membrane as per manufacturer's instructions and make a 100mm incision longitudinally in the breather membrane (to the line of the ridge tiles) in line with the roll below, ensuring that the ridge section below is not cut.

Lift one side of the breather membrane and fold the two halves of the upper roll pad together and gently insert these two halves of the pad through the incision and then fold the ridge section down over the ridge kit breather membrane.

The upper strip of roll should now be sitting over the breather kit membrane in a position that will be beneath the ridge tile.

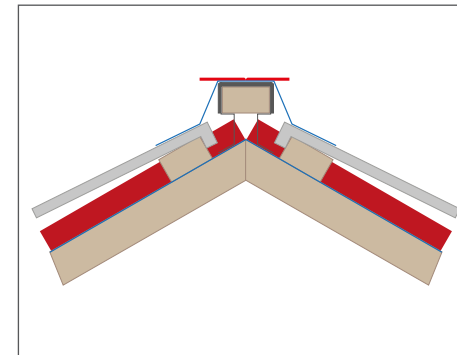

Fig. 9b – Ridge section below ridge tile

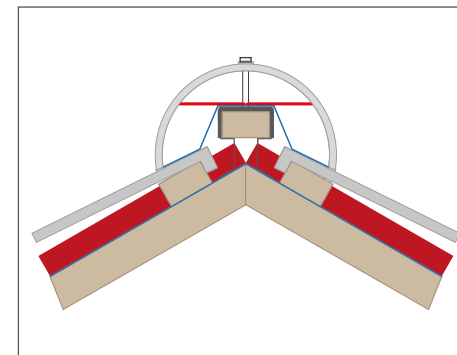

Fig. 10 – Complete ridge tiles

- 10 Fit the roof ridge tiles as per the manufacturer's instructions.



Tell me more



Call 01283 722588

Email info@marley.co.uk

Or visit www.marley.co.uk/roofdefence

Marley, Lichfield Road, Branston, Burton upon Trent, DE14 3HD