



# MANUFACTURER. DISTRIBUTOR. RECYCLER

Specification Guide – Window, Door and Roof Systems

**eurocell**<sup>®</sup>

*All together better*



# CONTENTS

## WELCOME TO EUROCELL

### Introduction

Discover Eurocell	4
A Guide to Specification	6
Our Product Range	8
Building Regulations Compliance	12
Recycled PVC-U	14
Our Accreditations	16

### Modus 75mm Window System

Overview	18
Features, Benefits & Options	20
Slim Rebate Sash Casement	24
Flush Sash Casement	26
Reversible Windows	28
Tilt & Turn Windows	30
French Doors	32
Entrance Doors	34
Product Chart	36

### Eurologik 70mm Window System

Overview	38
Features, Benefits & Options	40
Casement Windows	44
Tilt & Turn Windows	46
French & Residential Doors	48
French Doors	50
Joint Assemblies	52
Window Cills, Joints, Trims & Reinforcements	54
Product Charts	56

### Charisma Sash Windows

Overview	60
Features, Benefits & Options	62
Charisma & Charisma Classic Technical Drawings	66
Product Chart	68

### Cavalok Cavity Closers

Overview	70
Product Range	72
Installation Guide	76
Product Chart	78



## Aspect Bi-Fold Door System

Overview	80
Features, Benefits & Options	82
Door Configurations	86
Technical Information	88

## Euroslide Patio Door System

Overview	90
Features, Benefits & Options	92
Technical Information	94
PAS24 / Lifetime Homes	96
Product Chart	98

## The Dales Collection Composite Doors

Overview	100
Features, Benefits & Options	102
Composite Door Frame Components	106
Composite Door Style Options	108

## Skypod Roof Lanterns

Overview	110
Features, Benefits & Options	114
Product Range	114
Components	116
Assemblies	118

## Equinox Tiled Roof System

Overview	120
Features, Benefits & Options	122
Technical Information	124

## Conservatory Roof System

Overview, Features, Benefits & Options	126
Main Assemblies	130
Components	132

<b>PVC-U Profiles</b> Technical Information	134
---	-----

<b>Case Studies</b>	144
---------------------	-----

<b>Branch List</b>	154
--------------------	-----



## DISCOVER EUROCELL

THE UK'S LEADING PVC-U PROFILE MANUFACTURER,  
DISTRIBUTOR AND RECYCLER

Precision-manufactured PVC-U products designed to meet the aesthetic and regulatory demands of fabricators, specifiers and fitters – backed by on-time delivery, expert advice and hands-on support

### **Cradle-to-grave PVC-U solutions**

Eurocell is the UK's leading PVC-U product manufacturer, distributor and recycler thanks to a combination of precision extrusion capabilities, ceaseless product innovation and customer service excellence. That means we are the only UK PVC-U manufacturer to offer complete cradle-to-grave solutions, from manufacturing new products to disposing of old ones and recycling them into new components.

### **Investing in continuous product development**

Since 1974, we've been developing window, door and conservatory products that are designed not only to meet the specific needs of architects, specifiers, fabricators and installers, but also to help homeowners improve the appearance and energy efficiency of their properties. Our design and development team works with toolmakers, fabricators, hardware suppliers and customers to continuously improve the performance and appearance of our products to ensure they meet latest consumer demand and strict environmental legislation.

Our dedication to innovation, backed by massive investment in research, development and manufacturing equipment, means that Eurocell now offers the widest PVC-U product range of any single UK brand, backed by unrivalled technical support and design capabilities.



### **Assured-quality products delivered on time**

Such dedication to product excellence assures you of consistently high quality standards in every Eurocell product, matched by a fast, reliable distribution service. With a fleet of more than 200 delivery vehicles and state-of-the-art order-fulfilment technology at our advanced logistics centre, we have the ability to get your products where they are needed, right on schedule.

### **Unique colour-match guarantee**

All Eurocell products are manufactured in a wide range of colours and finishes, including more than 25 woodgrain options available on special order. Because we extrude all of our own window and door profiles, conservatory roofs and roofline products, Eurocell is the only manufacturer able to guarantee an exact colour match across PVC-U products for the entire building envelope – so you can offer customers a unified look and style for every part of their property.

### **BIM models and CAD drawings for accurate specification**

To support specifiers in planning, designing and costing more efficient and economical buildings, we offer an online BIM model library for our products, which is growing all the time. You can view and download BIM models quickly and easily at [www.eurocell.co.uk/bimmodels](http://www.eurocell.co.uk/bimmodels).

### **QUALITY SEAL OF APPROVAL**

Most Eurocell products are fully accredited by the British Board of Agrément (BBA), British Standards Institute (BSI) and approved by the Association of Chief Police Officers' Secured by Design initiative.

## A GUIDE TO SPECIFICATION

### MAXIMISING PVC-U FOR YOUR PROJECTS

Balancing an ideal specification against an actual budget can be difficult – and for this reason, we recommend specifiers obtain project-specific advice from the Eurocell technical department. However, the following provides an initial guide:

#### **Fabrication**

All main profiles are of multi-chambered construction for enhanced thermal performance, strength and effective separation of reinforcement from drainage channels. Our systems are fully welded, however a number of our products, can also be mechanically jointed using specially designed tooling and reinforcement. All frames must be manufactured in strict accordance with Eurocell technical manuals.

#### **Weather performance**

All window systems conform to the provisions of BS 6375 Part 1.

Specifiers are recommended to seek guidance from the Eurocell technical department for actual requirements of specific schemes/strengths.

#### **Operation and strength**

All window systems must meet the requirements of BS 6375: Part 2, specification for window operation and strength characteristics. Any optional safety or security additions should be vetted separately. All opening lights at first-floor level and above must conform to the requirements for safe window cleaning of Code of Practice BS 8213: Part 1.

#### **Reinforcement**

Eurocell product design policy is to manufacture integrated multi-chamber profile systems wherever possible. Sometimes additional reinforcement is required, depending on product specification and environmental conditions. This should be completed in accordance with the guidelines set out in the appropriate Eurocell technical manual.

## Glass and glazing

Refer to building regulations part K for location of safety glazing. Glass units must meet the requirements of BS EN 1279. Thermal and sound insulation can be dramatically improved by the use of specialist glazing products.

## Hardware

Eurocell window systems have been designed to be compatible with a wide range of hardware, and to cater especially for safety, security and the needs of the elderly and disabled.

## Ventilation

A range of ventilation options is available – adjustable ventilators to meet the Building Regulation Approved Document F requirements, and permanent ventilators for combustion air complying with BS 5440: Part 2.

## Maintenance and cleaning

The faces of window frames should be cleaned every 3-4 months with warm water and a mild liquid detergent. Abrasive cleaning agents should not be used. Proprietary glass cleaner is recommended for sealed units. Hardware should be lubricated with a light machine oil every 6-12 months. Concise guidance notes should be offered to end-users for routine maintenance and corrosion protection.

## Weather seals

Eurocell window systems use post co-extruded gasket weather seals for optimum performance and ease of fabrication.

\* Do not use any type of solvent to clean foiled products





## OUR PRODUCT RANGE

### AT A GLANCE

The range of PVC-U window, door and conservatory roof systems offered by Eurocell is constantly evolving to meet the aesthetic, security, energy-efficiency and value requirements of consumers, specifiers and fabricators.

#### **Modus** **Fully integrated 75mm window and door system**

Modus is a revolution in PVC-U window and door design, engineering and performance. It enables you to create a whole range of window and door types with the clean, slim-framed, flush-fitting styles that consumers crave.

With its superior thermal efficiency, Modus offers a genuine alternative to sought-after but expensive aluminium and timber products – offering considerably better value with no compromise on aesthetics and virtually no maintenance.





modus & modus S



eurologik window & door system



charisma vertical sliders



aspect bi-fold doors



skypod pitched skylights



dales collection composite doors



Fascias, soffits and guttering



euroslide patio doors



cavalok cavity closers



equinox tiled roof system



Conservatories



roomline skirting and architraves

## Modus S Square-jointed flush sash casement window system

For the ultimate in authentic traditional window looks, Modus S is an advanced mechanical joint flush sash system specially engineered to eliminate the tell-tale diagonal corner welds of standard PVC-U windows. Suited to premium properties, conservation area requirements and self-build projects, Modus S is the top-of-the-range Eurocell window system.

## Eurologik 70mm window and door system

The Eurologik profile system offers leading energy-efficiency performance and aesthetics. It is specially designed for ease and speed of fabrication and fitting.

Ideally suited for new-build or replacement windows, its 70mm front-to-back dimension enables the seamless replacement of timber frames.

The profile features multiple chambers to enhance thermal efficiency and strength, and improve drainage. Available in chamfered or sculptured ovolo styles in a range of colours, Eurologik profiles can be used to fabricate a full range of window and door styles.

## Charisma

### Vertical sliding sash windows

The Charisma vertical sliding sash window system enables you to achieve classically styled traditional windows with all the low-maintenance and thermal efficiency benefits of PVC-U.

As one of the most highly engineered vertical sliding windows on the market, it captures the stylish looks of the Georgian era, with none of the associated problems of draughts, rattling sashes and high maintenance.

The Charisma classic – an extension to the Charisma range – has been designed to meet the exacting planning requirements of conservation areas and historic buildings, with a deep bottom rail and unique design run-through horns.

### Cavalok Cavity closer systems

Cavalok PVC-U cavity closers are the simplest, most effective components for sealing cavities around openings in any wall – whether masonry, timber or steel. They are an essential component for any new-build project, helping to maximise thermal-efficiency performance, while minimising time spent on site to boost the productivity of installation teams.

The Cavalok cavity closer product range includes the one-hour fire-rated FlameBlok closer, and the BigBlok closer, which is uniquely designed to fit cavities up to 300mm wide.

### Aspect Bi-fold door system

This high-performance, secure and visually stunning bi-fold door system offers all the aesthetic and functional benefits of timber and aluminium alternatives, but at a more affordable price.

Aspect incorporates a host of intelligently designed and precision-engineered components that enable consistent, straightforward fabrication and installation – setting new standards for PVC-U bi-fold doors.

### Euroslide In-line patio doors

The space-saving Euroslide patio door system has been re-engineered to provide improved safety and strength – creating the best patio door system in its class. This highly secure system gives you a reliable way to provide a PAS24-certified product for your customers – automatically meeting the requirements of Document Q and Lifetime Homes standard.\*

*\*2 pane only*

## OUR PRODUCT RANGE

### AT A GLANCE



The Euroslide patio door system offers a host of innovative design features and is available in two, three or four-pane options. It is fully compatible with the Eurologik window and door profile system.

## **Dales Collection Composite entrance doors**

The Dales Collection of composite doors offers the most advanced engineering, design and technology for front or back entrance doors.

A huge range of styles, colours and glazing options is available to suit every home, with unrivalled aesthetics, security and energy efficiency for all residential building projects – whether new-build or refurbishment.

## **Skypod Lantern roofs**

The Skypod lantern roof system enables you to create an eye-catching, contemporary feature that floods the interior of a property with natural light.

It brings life, space and freshness to uninspiring flat-roofed buildings, and is an affordable, energy-efficient alternative to aluminium skylights – ideal for refurbishment, extension or new-build projects.

## **Equinox Tiled roof system**

Transform under-used conservatories into year-round living spaces with the market-leading Equinox tiled roof product.

Designed for fast, unobtrusive, precision installation, Equinox is available in a range of colours with a choice of slate-effect or steel tile finishes. Roof windows provide plentiful natural light while a multi-layered structure offers excellent energy efficiency.

The SlateSkin GRP sheet tile roofing system enables Equinox roofs to be tiled up to 50% faster than using standard composite tile systems.

## **Conservatory roof system**

Eurocell offers a full range of conservatory roof systems, fully compatible with all our high-performance doors and windows.

Designed for speed and ease of installation and fabrication, our bespoke conservatory roof enables you to fabricate any conservatory design, or you can choose from our range of classic styles, including Victorian, Edwardian and gable-ended.

Modus S casement windows in Irish Oak





# BUILDING REGULATIONS COMPLIANCE

## PVC-U PRODUCTS FOR SUSTAINABLE BUILDINGS

### Supporting carbon-neutral construction

Sustainability is a key issue for the construction industry. In the UK, buildings are responsible for producing around half the nation's total CO2 emissions, which is why the government is setting strict targets for carbon reduction to encourage more efficient, sustainable building design and construction.

As the UK's leading manufacturer of PVC-U building components, Eurocell has developed a range of high-performance, energy-efficient products to help specifiers, fabricators and fitters to achieve this target.

### PVC-U – the sustainable building material

Thanks to advances in recycling and product innovation, PVC-U is now widely recognised as a sustainable option for the construction industry. Old PVC-U window and door frames can be recycled and repurposed up to ten times without deterioration in quality or performance. According to the Building Research Establishment (BRE), the average lifespan of PVC-U windows is 35 years, which means PVC-U can offer up to 350 years of high performance, with minimal impact on the environment.

PVC-U windows have been given the highest rating possible in the BRE Green Guide to Specification, with an A rating for residential buildings and an A+ rating for commercial projects.

The main Eurocell PVC-U profile systems now contain up-to 50% recycled material.

### Building Regulations Part L

All Eurocell window systems comply with Part L of the Building Regulations. The performance of our window systems can be improved significantly by using very low-emissivity glazing, gas-filled units, warm-edge spacer bars and other enhancements to meet the most stringent energy-efficiency requirements.

At Eurocell, we have BFRC-certified simulators who are fully qualified to calculate U-values and Window Energy Ratings (WERs) and to advise on regulatory compliance. Please contact our design department for more information.

### Approved Document Q security regulations

Building Regulations Approved Document Q aims to prevent thieves breaking into a home through lower-level doors and windows. It applies to new-build properties, which must have windows and doors that are robust enough to resist physical attack by a burglar, and must be fitted with appropriate high-security hardware. Door and window products that have been certified to PAS 24 comply with all Document Q requirements – and any firm with 'Secured by Design' (SBD) New Homes 2014 certification will also meet the requirements.

# A GUIDE TO WINDOW ENERGY RATINGS (WER)

## What are energy ratings?

Window Energy Ratings (WER) provide information about the energy efficiency of windows. The British Fenestration Ratings Council (BFRC) checks all the parts of a window and then grades its performance accordingly. The scale goes from A++ to E, with 'A++' being the most efficient, and 'E' the least. The latest Building Regulations require all new homes to have windows with a minimum 'C' WER rating.

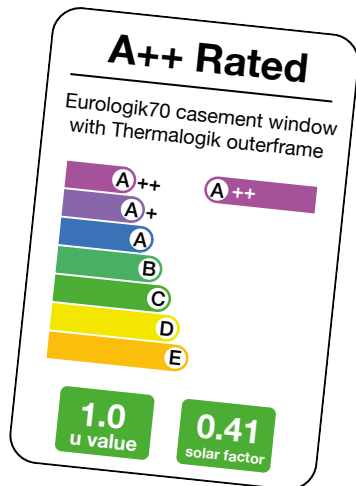

## How are they calculated?

The rating is determined by a formula which takes into account various factors, all of which have an effect on the overall energy performance of the window:

- ▶ UK Standard Domestic Occupancy
- ▶ UK climate data
- ▶ Thermal transmittance (window U value)
- ▶ Solar factor (G value)
- ▶ Air leakage (L value)

## What do WER labels tell you?

The labels are similar to those used on other household appliances. An A++-rated window is the most efficient, and E the least efficient.

For information or advice on Door Energy Ratings (DERs), please contact our technical department or visit [www.bfrc.org/TradeMain/doors](http://www.bfrc.org/TradeMain/doors).

## Building Regulations Part M

Private housing has been covered by Building Regulations Part M since 1 October 2015. Planning departments will determine the level of compliance required, based on the local plan. There are three compliance levels – Categories 1-3 – based on the needs of occupiers.

## Local Plans and Optional Requirements

Every Local Authority is expected to have a Local Plan for managing the housing needs of its area, taking account of the specific demographics of the area. It means that planning authorities have the right to request Optional Requirements over and above the minimum standards set out in Building Regulations, in return for granting planning permissions.

## Penalties for non-compliance

It's essential to ensure that any building work complies fully with the relevant Building Regulations. The fine for non-compliance with Building Regulations is now unlimited.

## Window design regulations

When designing windows to achieve regulatory compliance you should consider the following:

- ▶ Updated Building Regulations Part L (April 2014) require a U value of 1.60w/m<sup>2</sup>K for windows and external doors in both new and existing properties or a WER (Window Energy Rating) of 'C'.
- ▶ If you are considering a zero-carbon build, you need to choose a window design that achieves a U-value of 0.8w/m<sup>2</sup>K, or better.
- ▶ 0.8 U-value (or better) windows are an important element in passive home design. These use solar energy to provide heating, cooling, and lighting for a house.

## A++ rated performance

Eurocell offers A++ rated energy-efficient window systems that allow you to deliver sustainable products to your customers. The Eurocell Modus and Eurologik systems produce market-leading A++ rated windows, with U-values as low as 0.7 and WER Energy Index Ratings of A++31, certified by the British Fenestration Ratings Council (BFRC).



## RECYCLED PVC-U

### IN-HOUSE CLOSED-LOOP RECYCLING FOR END-TO-END SUSTAINABILITY

PVC-U is a highly sustainable product, robust enough to be recycled and repurposed up to ten times without detriment to its quality or performance. Eurocell reuses almost 100% of its own production waste. But we go much further than that. At our recycling plant in Derbyshire – the largest in the UK – we process up to 12,000 old PVC-U window frames per week. Once recycled, this material is used to create a variety of new products, from cavity closers to our revolutionary Modus window system. This means we minimise the amount of waste going to landfill.

360° approach – for reduced cost and energy consumption  
Wherever possible, we offer a ‘closed loop’ service, re-engineering the PVC-U taken from old frames to make new windows, doors and building products. This process uses less

energy and gives customers a high-performance, more efficient product. We even collect PVC-U waste from fabricators and trade customers free of charge, for processing at our recycling plant.

#### **Environmental accreditations**

The Eurocell environmental management system has achieved the widely recognised ISO 14001 accreditation. Our environmental policy commits us to ongoing improvements that will help us to reduce carbon emissions from transport and energy use, improve energy efficiency in our business and offer more energy-efficient products to our customers, as well as further reducing waste and promoting recycling in all areas of our business.



## SERIOUS ABOUT SUSTAINABILITY

- ▶ Our PVC-U Thermal Inserts and Cavalok cavity closers are made from 100% recycled PVC-U
- ▶ Modus and Eurologik window and door systems are made using up-to 50% recycled PVC-U
- ▶ Up to 12,000 end of life frames are recycled each week
- ▶ Almost 100% of production waste re-used
- ▶ We recycle 22,000 tonnes of waste PVC-U each year
- ▶ We provide a free PVC-U waste collection and storage service



## OUR ACCREDITATIONS

YOUR GUARANTEE OF HIGH QUALITY STANDARDS

All Eurocell products are manufactured to stringent specifications in a carefully controlled environment where high standards can be maintained and guaranteed. To give customers the assurance that all Eurocell products meet the highest standards, we have achieved accreditations from leading UK certification bodies.

Eurocell products meet the requirements of current Building Regulations, and exceed the standards set out in Part L1 and 2 Conservation Of Fuel & Power (Windows).

As new regulations are introduced, Eurocell remains committed to meeting and exceeding these ever more demanding standards, so that we continue to set the quality benchmark for the building plastics industry.

### AWARDS



**Manufacturer of the Year**



**Materials Recycler of the Year (large)**



**Sustainable Company of the Year Finalist**

### CCIEM

**Sustainability Manufacturing Leaders**



**Aspect bi-fold doors**  
Highly commended



**Best Product Launch**





**Assessment report number 2480**  
The Eurologik window and door system



Eurocell's PAS 24 high security windows have gained Secured by Design status



**Assessment report number 00/3673**  
The Cavalok cavity closer system



Eurocell's composite doors have gained Secured by Design status



**Assessment report number 2663**  
The Eurocell vertical slider system



Eurocell's Aspect bi-fold doors have gained Secured by Design status



**Assessment report number 13/5043**  
The Eurocell Aspect bi-fold door system



**Assessment report number 14/5150**  
Modus single leaf and double leaf door system  
**Assessment report number 14/5154**  
Modus fully reversible system



**BS EN 12608 (certificate number KM 32821)**  
Specification for white PVC-U extruded hollow profiles with heat welded corner joints for plastic windows and Eurocell window systems, type 'A' material



BPF Windows Group give codes of practice guidelines and recommendations for both surveying and installation of PVC-U windows and door-sets



**PAS 24 (certificate number KM 52187)**  
Enhanced window system supplier



**Certificate number FM 45551**  
BSI registered firm.  
Quality Management System

**BS EN ISO 9001:2008**



**PAS 24 (certificate number 500319)**  
Enhanced door system supplier



**ISO 14001**  
Eurocell's environmental management activities are ISO 14001 accredited



**Certificate No: EW606**  
Eurocell Equinox Solid Roof system

**PAS 23/24**

**Eurocell composite door system**  
ERA test centre  
To-PAS 23-1 and PAS 24-1  
Certificate number 050



Member

**BRE supply partner to the Exemplar projects**



modus®

## FULLY INTEGRATED CONTEMPORARY 75MM WINDOW AND DOOR SYSTEM

Clean, contemporary looks, slim sightlines and superior thermal efficiency

Modus represents a revolution in PVC-U window and door design, engineering and performance. Nothing can beat its combination of aesthetics, performance and value for money. It enables you to create a whole range of window and door types and styles using a single system.

Unrivalled versatility to create multiple window styles  
From casement, reversible and tilt-and turn windows to French doors and entrance doors, Modus allows you to create the clean, slim-framed, flush-fitting styles that consumers crave. As well as offering such unrivalled versatility, Modus is easier and faster to fabricate than other leading systems on the market.

Energy-efficient alternative to timber and aluminium frames  
With its superior thermal efficiency, Modus offers a genuine alternative to sought-after but expensive aluminium and timber products – offering considerably better value with no compromise on aesthetics and virtually no maintenance.

### modus® S – innovative square-jointed flush sash casement system for traditional aesthetics

For the ultimate in timber or aluminium looks, the Modus S is an advanced flush sash system specially engineered to eliminate the tell-tale diagonal corner welds of standard PVC-U windows. The mechanically jointed system has been precision engineered to create a flush sash with perfect square joints, without the need for welding.

The aesthetics of Modus S mean that it can be specified for prestigious developments where planning requirements or aesthetic restrictions would not normally allow PVC-U windows to be considered.



Modus S square joint flush sash casement windows



Modus S system components



modus®

## FULLY INTEGRATED CONTEMPORARY 75MM WINDOW AND DOOR SYSTEM

### Nine systems in one

Modus offers the ultimate in flexibility, enabling you to create a whole range of popular window and door styles from a single PVC-U system.

### Standard sash casement windows

You can create a vast range of casement window styles and configurations, including wide-opening French windows. Our sash casements have 28mm (double) and 44mm (triple) glazing options.

### Slim rebate sash casement windows

Offering clean sight lines with an internally flush sash and slim external rebate, allowing a variety of window configurations. Better thermal performance than equivalent aluminium systems.

### Flush sash casement windows

With internally and externally flush sash, this window rivals timber for aesthetics. It is the first dual material extrusion technology (DMET) flush sash, offering superior thermal performance to timber windows.

### Reversible windows

With a completely flush sash, Modus offers the first DMET reversible system in the UK, providing the most thermally efficient product currently available.

### Tilt & Turn windows

Featuring a stepped sash design for improved aesthetics and thermal performance, with dummy mullion and no need for steel reinforcement.\*

### Entrance doors

With slim sightlines and equal 8mm of cover inside and out.

### French doors

A dedicated French door mullion offering improved aesthetics and thermal performance.

### Composite door frame

The Modus outer frame, transom and mullion is compatible with 56mm or rebated 70mm panels for improved thermal performance over existing 44mm doorsets.

\* Depending on size and location

## FEATURES AND BENEFITS

- ▶ Sleek, contemporary styling for authentic traditional aesthetics.
- ▶ Four casement sash type options: standard rebate, slim rebate sash, flush sash and mechanical joint flush sash.
- ▶ Available in more than 30 colours and finishes, including wood grain and metallic look options.
- ▶ Unique 75mm six-chamber profile offers superior thermal efficiency, enabling A++ Window Energy Rating and a 0.7 U-value – exceeding Passive House standards.
- ▶ Sustainable product using up-to 50% post-consumer recycled PVC-U as standard.\*
- ▶ Modus S costs up to 50% less than the nearest equivalent product.
- ▶ 12-year profile guarantee.\*\*
- ▶ Traditional architectural looks are perfect for premium properties, conservation areas and self-build projects where planning restrictions would exclude other PVC-U systems.
- ▶ Advanced profile design for fast, simple fabrication.
- ▶ BBA certification for quality assurance – certificate numbers 14/5154 (Casement Tilt & Turn & Reversible windows) and 14/5150 (Door systems)
- ▶ ACPO Secured by Design (SBD) accredited (with appropriate fabricator certification)

\* Average. Post-consumer and virgin PVC-U content varies between profiles. \*\* White profiles only

## PRODUCT RANGE



Standard sash casement windows



Slim rebate sash casement windows



Flush sash casement windows

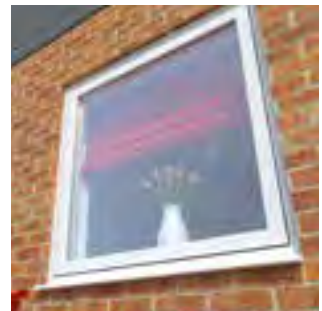

Reversible windows



Entrance doors



French doors



Composite door frame



Tilt & Turn windows



modus®

## FULLY INTEGRATED CONTEMPORARY 75MM WINDOW AND DOOR SYSTEM

### Superior energy efficiency and thermal performance

Eurocell has invested £3million in research and development to enable Modus to deliver industry-leading energy efficiency. A triple-seal option provides superior thermal performance and air tightness, enabling you to achieve U-values as low as 0.7–exceeding Passive House standards.

By specifying Modus profiles, double- and triple-glazing costs can be significantly reduced, making like-for-like windows more cost-effective. With such exceptional thermal performance, Modus is supporting the drive towards an affordable zero-carbon future.

### Built-in sustainability – 50% recycled PVC-U content

Environmental sustainability is one of the biggest issues in construction today. That's why as well as offering superior energy-efficiency performance, Modus is made from up-to 50%\* recycled PVC-U as standard. Intelligent design engineering means that the recycled material is concentrated in the central core of the profiles, where it is invisible in an installed window. The outer face remains virgin PVC-U – which guarantees colour-matching, UV stability and finish quality.

Manufactured and recycled at our state-of-the-art plants in Derbyshire, Modus achieves a lower carbon footprint than rival systems manufactured or recycled outside the UK.

\* Average. Post-consumer and virgin PVC-U content varies between profiles.

## COLOUR OPTIONS

The Modus standard colour range has been extended to meet the changing needs and tastes of today's consumers. Our standard colour range is available from stock, ready for delivery. A further range of more than 25 colours is available to order for delivery in just three weeks. Standard, woodgrain or smooth metallic finishes are available to create the aesthetic that you need.

MODUS IS AVAILABLE IN THE FOLLOWING COLOURS AS STANDARD (WHITE INTERIOR UNLESS STATED):

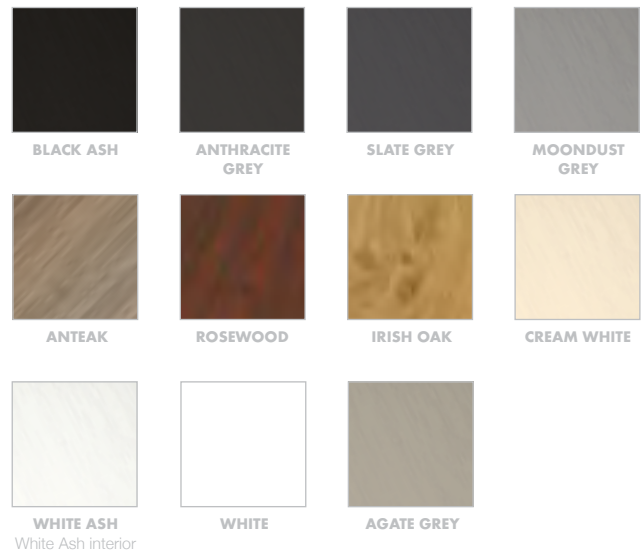

Modus S casement windows in Irish Oak



# TECHNICAL INFORMATION

## SLIM REBATE SASH CASEMENT



modus slim rebate sash casement windows offer flush internal aesthetics for ultimate sleek looks

modus slim rebate sash windows offer internally flush and externally slim rebated sashes for a sleek look to rival aluminium systems. A range of Grey and metallic finishes add to the aesthetic, and you can even experiment with differing internal finishes. This delivers significant cost savings over aluminium, as well enhanced thermal performance.

Min / max sizes	Width (mm)	Height (mm)
Top hung (espag)	Min: 320 Max: 1200	Min: 375 Max: 1350
Side hung	Min: 400 Max: 750	Min: 320 Max: 1500
Fixed	Max: 1500	Max: 2100

Config	Glass 1 (external)	Glass 2 (internal)	Glass 3 (internal)	Gas fill	Spacer bar	Reinforcing	WER	Energy index	U value
4/16/4/16/4	Diamant	Planitherm One	Planitherm One	Krypton	SuperSpacer Premium	Full Thermal	A	9	0.7
4/16/4/16/4	Optiwhite	Pilkington KS	Pilkington KS	Argon	SuperSpacer Premium	Full Thermal	A++	31	0.8
4/20/4	Optiwhite	N/A	Pilkington KS	Argon	SwisSpacer Ultimate	None	A+	12	1.3
4/20/4	Diamant	N/A	Planitherm Total+	Argon	SuperSpacer Premium	None	A+	12	1.3
4/20/4	Float	N/A	Planibel A	Argon	SuperSpacer Premium	None	A	2	1.4



### Slim rebate sash window Triple-glazed

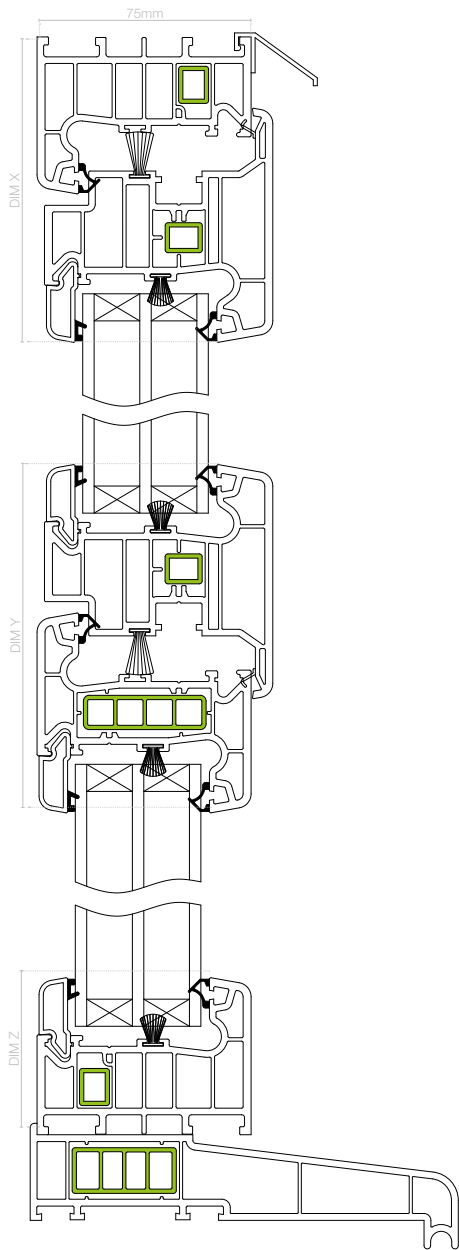

Frame dimension	Dim X
Main Frame (LSF 1021) with Slim Rebate Sash (LSF 1004)	107mm
Large Main Frame (LSF 1006) with Slim Rebate Sash (LSF 1004)	122mm

### Slim rebate sash window Double-glazed

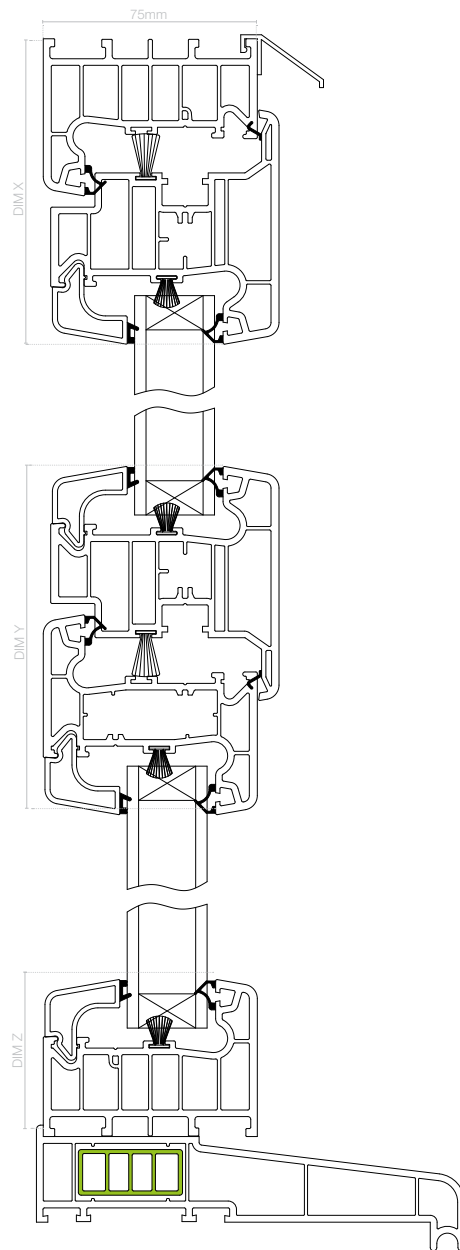

Frame dimension	Dim Y
Slim Rebate Sash (LSF 1004) with Transom Z (LSF 1003)	122mm
Slim Rebate Sash (LSF 1004) with Intermediate Transom Z (LSF 1023)	137mm

Frame dimension	Dim Z
Main Frame (LSF 1021)	55mm
Large Main Frame (LSF 1006)	70mm

# TECHNICAL INFORMATION

## FLUSH SASH CASEMENT



modus flush sash windows in Irish Oak offer a quality, natural woodgrain appearance to rival timber

modus flush sash casement windows offer internally and externally flush sashes for an aesthetic to rival timber systems. A range of woodgrain foils means you can achieve a truly natural woodgrain appearance, without the associated costs. It is the first co-extruded flush sash on the UK market, and offers better thermal performance than traditional timber windows.

Min / max sizes	Width (mm)	Height (mm)
Top hung (espag)	Min: 320 Max: 1200	Min: 375 Max: 1350
Side hung	Min: 400 Max: 750	Min: 320 Max: 1500
Fixed	Max: 1500	Max: 2100

Config	Glass 1 (external)	Glass 2 (internal)	Glass 3 (internal)	Gas fill	Spacer bar	Reinforcing	WER	Energy index	U value
4/16/4/16/4	Diamant	Planitherm One	Planitherm One	Krypton	SuperSpacer Premium	Full Thermal	A	9	0.7
4/16/4/16/4	Optiwhite	Pilkington KS	Pilkington KS	Argon	SuperSpacer Premium	Full Thermal	A++	31	0.8
4/20/4	Optiwhite	N/A	Pilkington KS	Argon	SwisSpacer Ultimate	None	A+	13	1.3
4/20/4	Diamant	N/A	Planitherm Total+	Argon	SuperSpacer Premium	None	A+	13	1.3

Contact our Technical department for additional performance specifications

## Flush sash window Triple-glazed

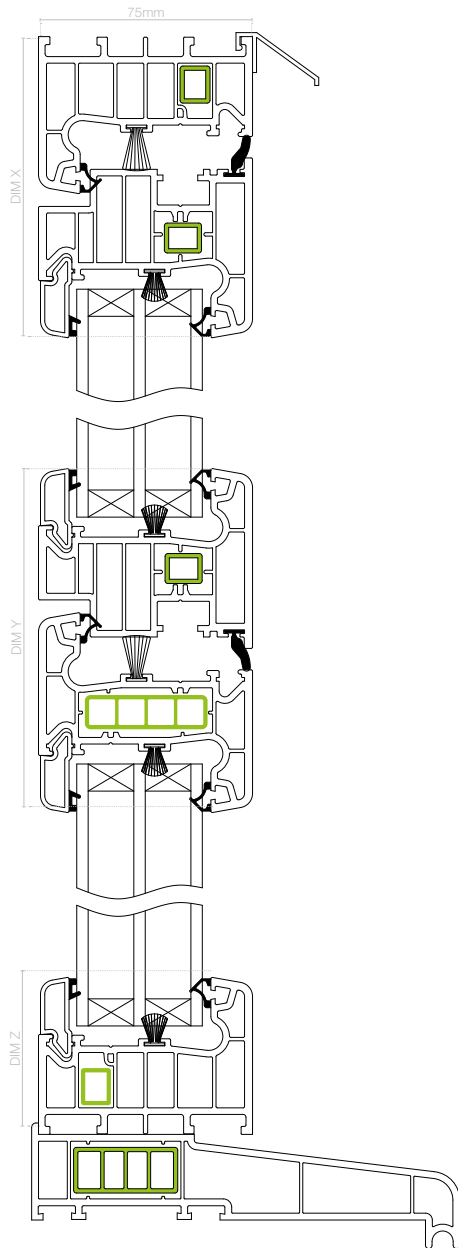

Frame dimension	Dim X
Main Frame (LSF 1021) with Reversible Sash (LSF 1008)	105mm
Large Main Frame (LSF 1006) with Reversible Sash (LSF 1008)	120mm

## Flush sash window Double-glazed

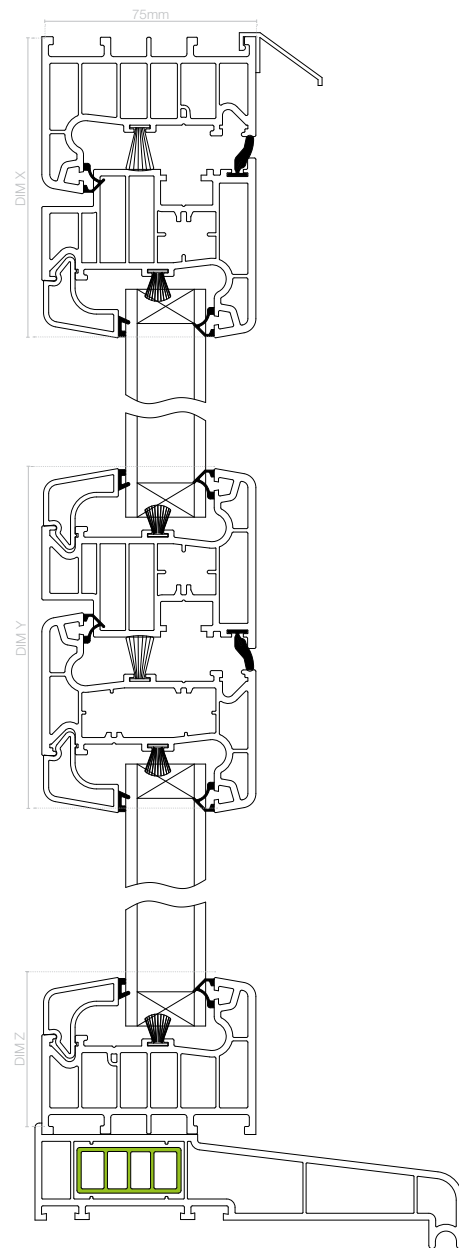

Frame dimension	Dim Y
Reversible Sash (LSF 1008) with Transom Z (LSF 1003)	120mm
Reversible Sash (LSF 1008) with Intermediate Transom Z (LSF 1023)	135mm

Frame dimension	Dim Z
Main Frame (LSF 1021)	55mm
Large Main Frame (LSF 1006)	70mm

# TECHNICAL INFORMATION

## REVERSIBLE WINDOWS



modus reversible windows have a completely flush sash internally and externally. As the first co-extruded reversible system in the UK, this innovative product delivers enhanced aesthetics as well as being the most thermally efficient in the UK. With a U-value as low as 0.7 achievable with a triple-glazed unit, it is the clear choice for new build and commercial projects.

Min / max sizes	Width (mm)	Height (mm)
Reversible windows	Min: 400 Max: 1250	Min: 563 Max: 1500
Fixed	Max: 1500	Max: 2100

Config	Glass 1 (external)	Glass 2 (internal)	Glass 3 (internal)	Gas fill	Spacer bar	Reinforcing	WER	Energy index	U value
4/16/4/16/4	Diamant	Planitherm One	Planitherm One	Argon	SuperSpacer Premium	Full Thermal	A	3	0.8
4/16/4/16/4	Optiwhite	Pilkington KS	Pilkington KS	Argon	SuperSpacer Premium	Full Thermal	A++	30	0.8
4/20/4	Diamant	N/A	Planitherm Total+	Argon	SuperSpacer Premium	None	A+	11	1.3
4/20/4	Optiwhite	N/A	Pilkington KS	Argon	SwisSpacer Ultimate	None	A+	11	1.3

Contact our Technical department for additional performance specifications

## Reversible window Triple-glazed

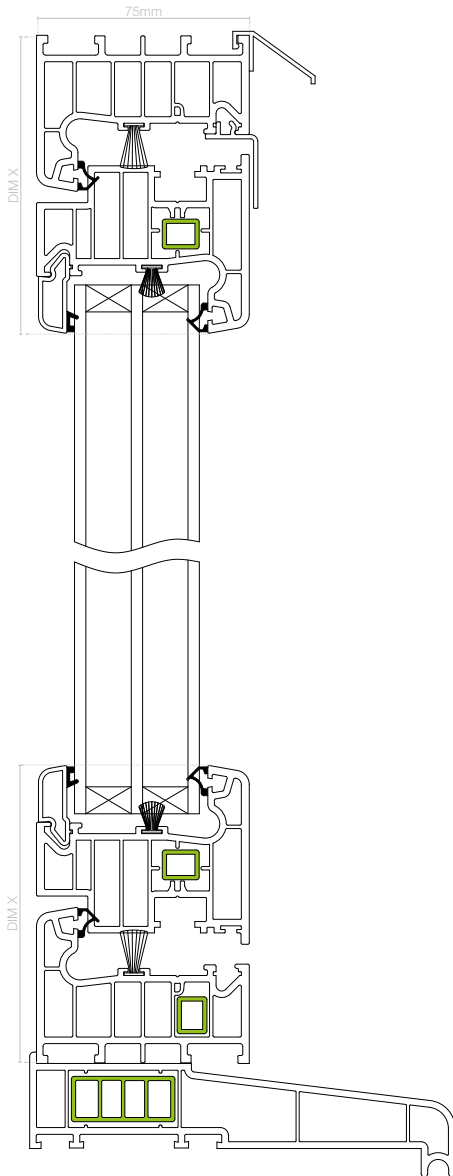

## Reversible window Double-glazed

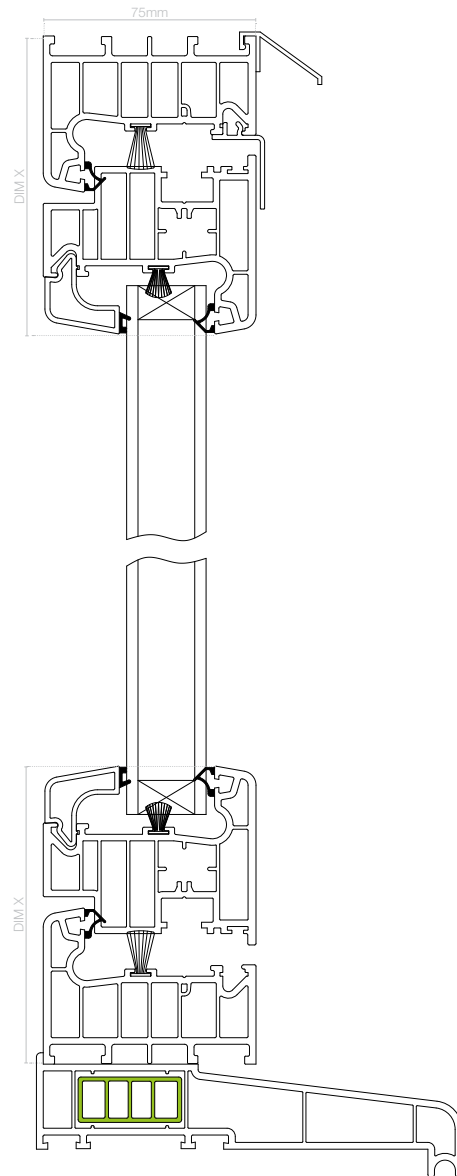

Frame dimension	Dim X
Main Frame (LSF 1021) with Reversible Sash (LSF 1008)	105mm
Large Main Frame (LSF 1006) with Reversible Sash (LSF 1008)	120mm

# TECHNICAL INFORMATION

## TILT AND TURN WINDOWS



Dual opening **modus** tilt and turn windows are ideal for high-rise buildings where cleaning access is restricted

**modus** tilt and turn windows feature a stepped sash design that is complemented by a variety of foil options, including stunning new metallic foils in the Architectural Range. With no need for steel reinforcements and U-values as low as 0.7 achievable with a triple-glazed unit, it's the clear choice for commercial works.

Min / max sizes	Width (mm)	Height (mm)
Tilt and turn windows	Min: 550 Max: 1500	Min: 550 Max: 1500
Fixed	Max: 1500	Max: 2100

\* Dependant on size and location

Config	Glass 1 (external)	Glass 2 (internal)	Glass 3 (internal)	Gas fill	Spacer bar	Reinforcing	WER	Energy index	U value
4/16/4/16/4	Diamant	Planitherm One	Planitherm One	Krypton	SuperSpacer Premium	Full Thermal	A	9	0.7
4/16/4/16/4	Diamant	Planitherm One	Planitherm One	Argon	SuperSpacer Premium	Full Thermal	A	5	0.8
4/16/4/16/4	Optiwhite	Pilkington KS	Pilkington KS	Argon	SuperSpacer Premium	Full Thermal	A++	31	0.8
4/20/4	Optiwhite	N/A	Pilkington KS	Argon	SwisSpacer Ultimate	None	A	14	1.3
4/20/4	Diamant	N/A	Planitherm Total+	Argon	SuperSpacer Premium	None	A+	14	1.3

Contact our Technical department for additional performance specifications

**Tilt and Turn window**  
Triple-glazed

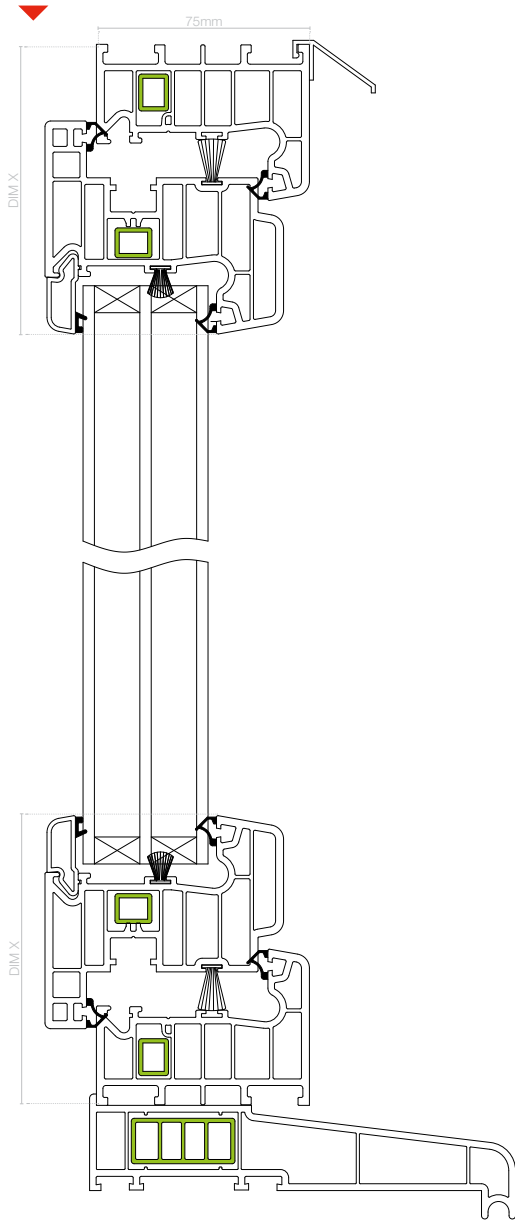

**Tilt and Turn window**  
Double-glazed

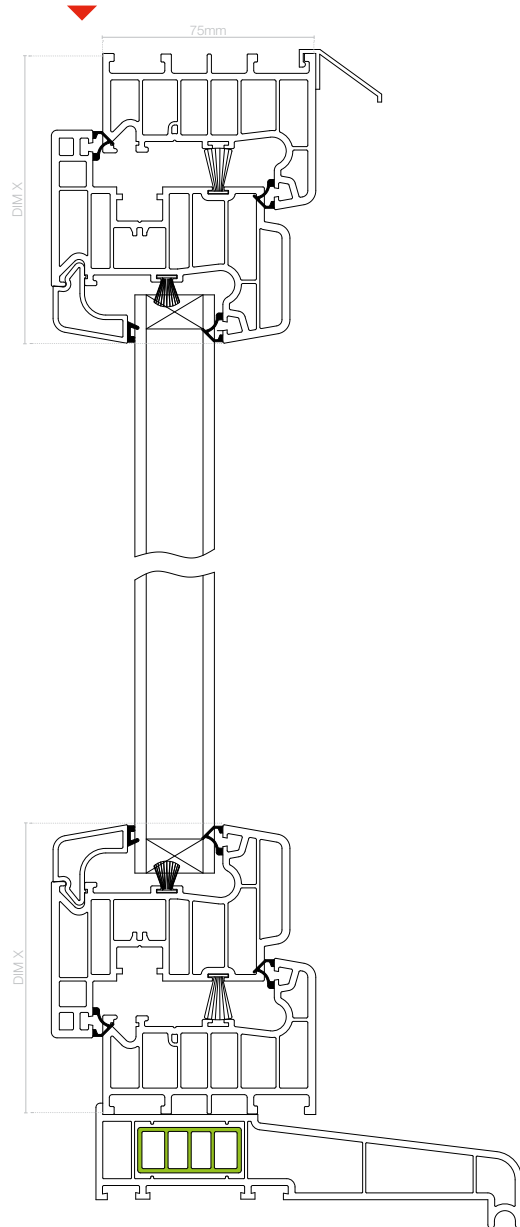

Frame dimension	Dim X
Main Frame (LSF 1021) with Tilt & Turn Sash (LSF 1007)	103mm
Large Main Frame (LSF 1006) with Tilt & Turn Sash (LSF 1007)	118mm

# TECHNICAL INFORMATION

## FRENCH DOORS



These stunning modus French doors feature sleek, flat faces and authentic timber aesthetics

modus French doors feature sleek, flat faces for sophisticated looks. A dedicated mullion with a slim rebate improves sightlines, whilst an option of an additional third seal to improve weather performance is also available. Maximum thermal performance can be achieved with a triple-glazed specification, offering U-values as low as 0.8.

Min / max sizes	Width (mm)	Height (mm)
French doors	Min: 1200 Max: 2000	Min: 1800 Max: 2300

Config	Glass 1 (external)	Glass 2 (internal)	Glass 3 (internal)	Gas fill	Spacer bar	Reinforcing	WER	Energy index	U value
4/16/4/16/4	Diamant	Planitherm One	Planitherm One	Argon	SuperSpacer Premium	Full Thermal	B	-2	0.8
4/16/4/16/4	Optiwhite	Pilkington KS	Pilkington KS	Argon	SuperSpacer Premium	Full Thermal	A+	22	0.8
4/20/4	Optiwhite	N/A	Pilkington KS	Argon	SuperSpacer Premium	Full	A	8	1.2
4/20/4	Diamant	N/A	Planitherm One	Argon	SuperSpacer Premium	Full	C	-13	1.2



**French doors**  
Triple-glazed

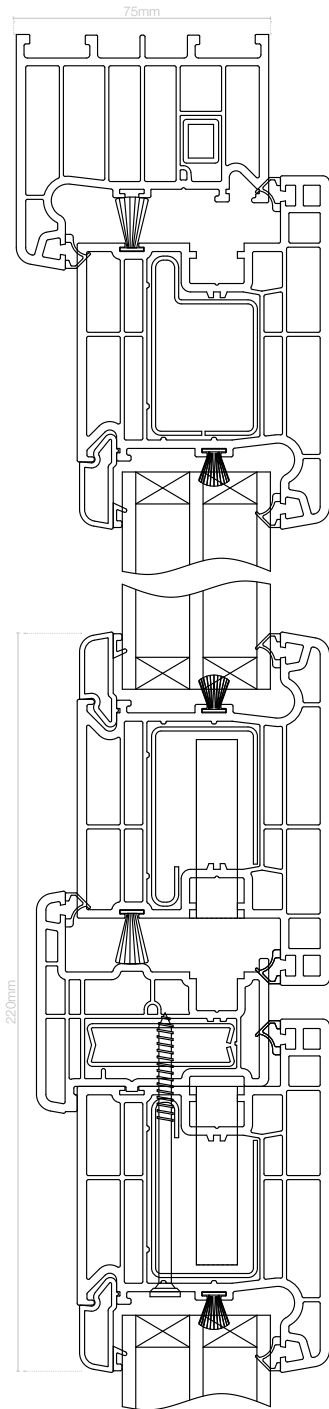

**French doors**  
Double-glazed

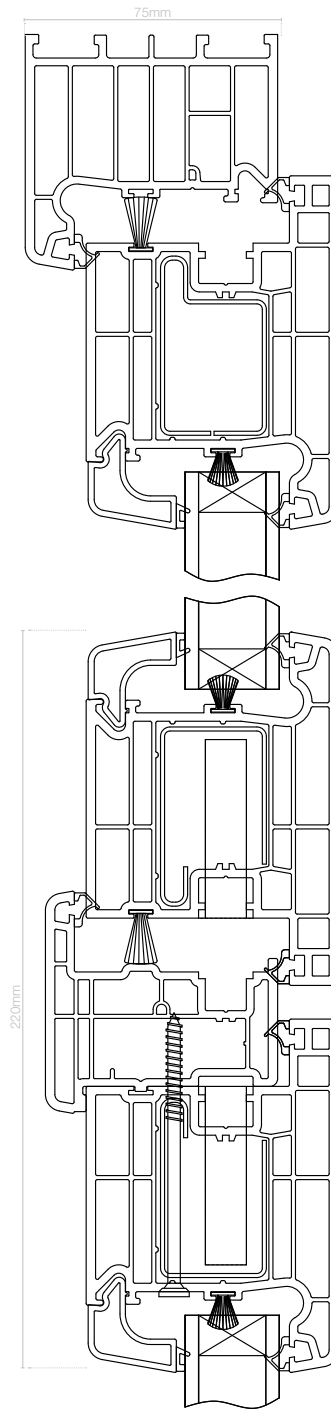

# TECHNICAL INFORMATION

## ENTRANCE DOORS

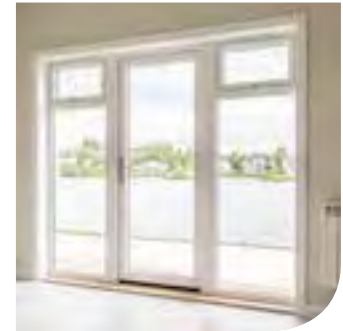

The possibilities are endless with **modus** entrance doors

**modus** entrance doors offer ultimate flexibility. Whether you choose panels or glazing, the design options are plentiful, and even include the ability to mechanically join the transom or mid-rail. As with the French door, an optional third seal can be utilised to improve weather performance and U-values as low as 0.8 can be achieved with a triple glazed unit.

### Min / max sizes

	Width (mm)	Height (mm)
Entrance doors	Min: 800 Max: 1000	Min: 1800 Max: 2300

Config	Glass 1 (external)	Glass 2 (internal)	Glass 3 (internal)	Gas fill	Spacer bar	Reinforcing	WER	Energy index	U value
4/16/4/16/4	Float	Planitherm One	Planitherm One	Argon	SuperSpacer Premium	Full	A++	-56	0.8
4/16/4/16/4	Optiwhite	Pilkington KS	Pilkington KS	Argon	SuperSpacer Premium	Full	A++	-60	0.9
4/20/4	Optiwhite	N/A	Pilkington KS	Argon	SuperSpacer Premium	Full	A	-87	1.3
4/20/4	Float	N/A	Planitherm One	Argon	SuperSpacer Premium	Full	A	-81	1.2

Contact our Technical department for additional performance specifications

**Entrance door (with mid rail)**  
Triple-glazed

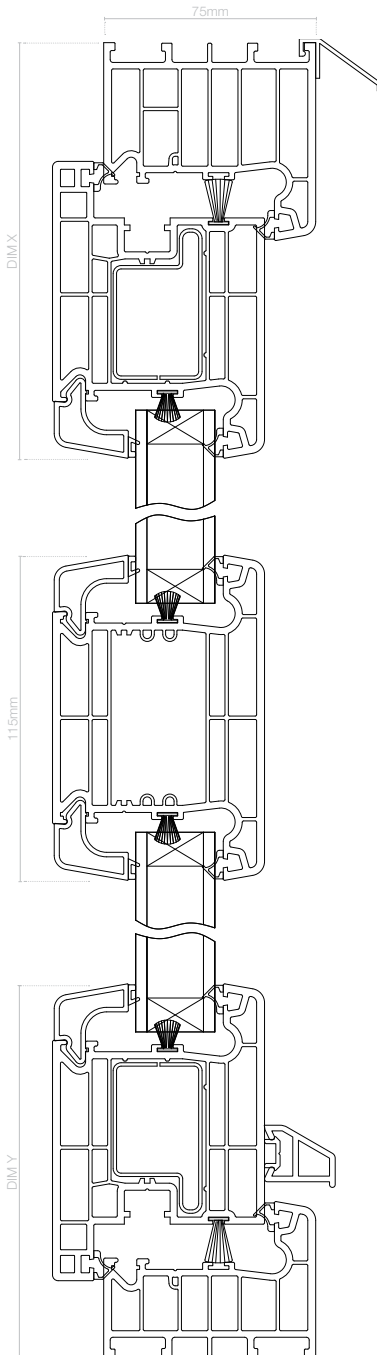

**Entrance door**  
Double-glazed

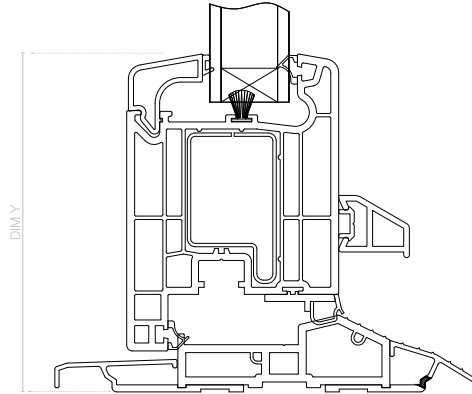

Frame dimension	Dim X
Main Frame (LSF 1021) with Door Sash T (LSF 1019)	132mm
Large Main Frame (LSF 1006) with Door Sash T (LSF 1019)	147mm

Frame dimension	Dim Y
Low threshold (LSF 1458) with Door Sash T (LSF 1019)	118mm
Main Frame (LSF 1021) with Door Sash T (LSF 1019)	132mm
Large main frame (LSF 1006) with Door Sash T (LSF 1019)	147mm
Part M low threshold with Door Sash T (LSF 1019)	120mm

### MAIN PROFILES

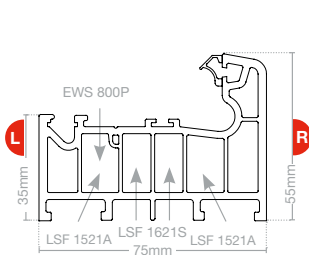

Main frame  
**LSF 1021**

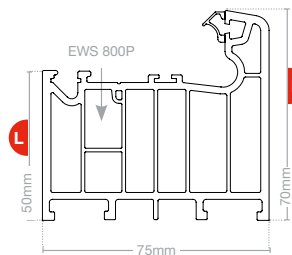

Large main frame  
**LSF 1006**

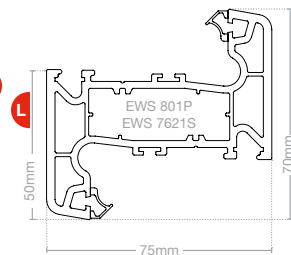

Transom Z  
**LSF 1003**

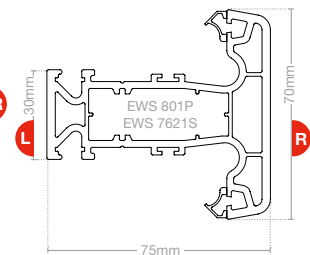

Transom T  
**LSF 1002**

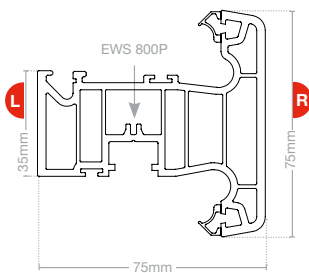

Sash T  
**LSF 1005**

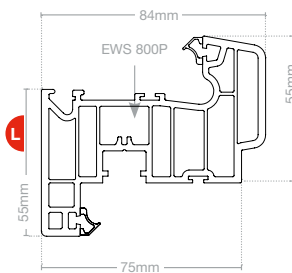

Tilt & turn flush sash  
**LSF 1007**

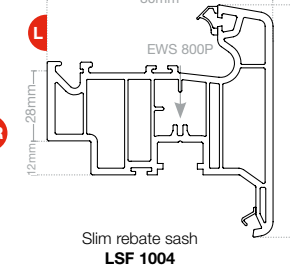

Slim rebate sash  
**LSF 1004**

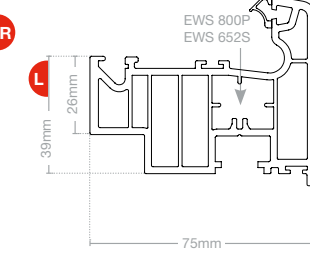

Reversible / Flush sash  
**LSF 1008**

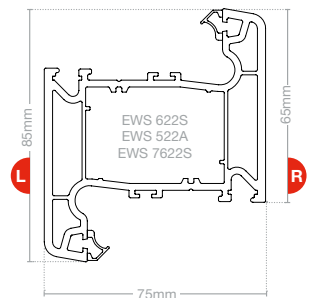

Intermediate Transom Z  
**LSF 1023**

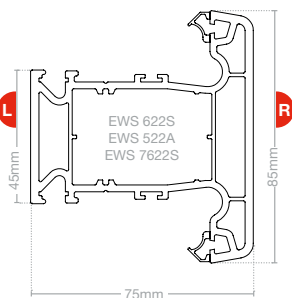

Intermediate Transom T  
**LSF 1022**

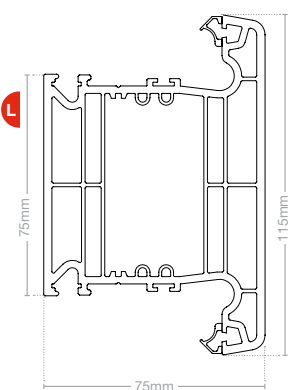

Door mid rail  
**LSF 1009**

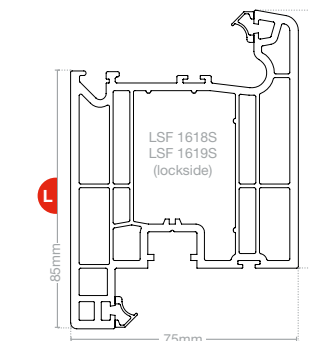

Door sash Z  
**LSF 1018**

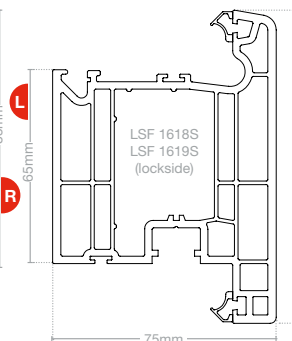

Door sash T  
**LSF 1019**

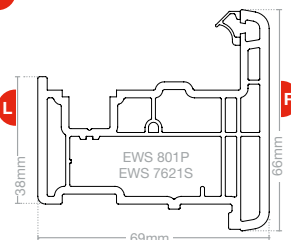

French door mullion  
**LSF 1016**

### BEADS

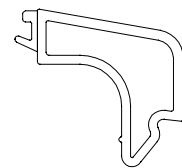

28mm bead  
**LSF 1301**

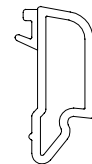

44mm bead  
**LSF 1302**

**ALUMINIUM EXTRUSIONS**



Butt joint  
**LSF 1510A**

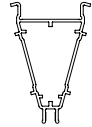

150° bay post  
**LSF 1516A**

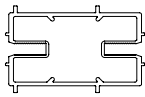

Structural butt joint  
**LSF 1528A**

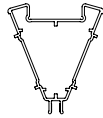

135° bay post  
**LSF 1517A**

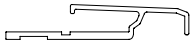

Threshold ramp B  
**LSF 1547A**



Square bay post  
**EWS 520A**

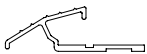

Threshold ramp A  
**LSF 1546A**



Bay pole  
**EWS 513A**



Curtain wall clamp plate  
**LSF 1564A**

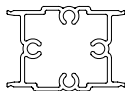

Aluminium reinforcement  
**EWS 522A**

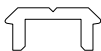

Drip bar fixing rail  
**EWS 515A**

**MISCELLANEOUS COMPONENTS**



Glazing seal  
**EWS 431G**

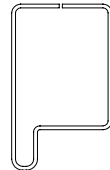

Door sash  
**LSF 1618**

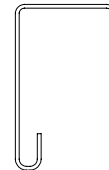

Door sash (punched)  
**LSF 1619**



Steel reinforcement  
**EWS 652S**



Sash seal  
**EWS 7471G**

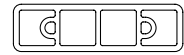

PVC-U thermal insert  
**EWS 801P**



Composite door & Flush sash brush pile  
**LSF 1431GWP**

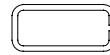

Main frame steel reinforcing  
**LSF 1621S**



Aluminium Mechanical Joint  
**LSF 1521A**



Repair gasket  
**EWS 7402G**



PVC-U thermal insert  
**EWS 800P**

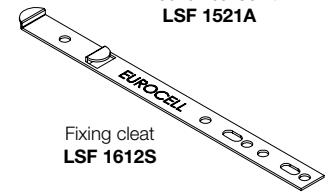

Fixing cleat  
**LSF 1612S**



Flush sash QLON  
**LSF 1408G**

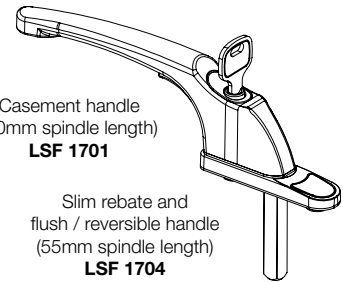

Casement handle (40mm spindle length)  
**LSF 1701**

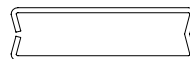

Steel reinforcement  
**EWS 7621S**

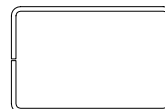

Steel reinforcement Std  
**EWS 622S**  
H/D **EWS 7622S**

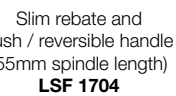

Slim rebate and flush / reversible handle (55mm spindle length)  
**LSF 1704**

**PVC-U ANCILLARIES**



10mm frame extension  
**LSF 1116**

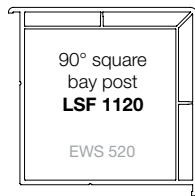

90° square bay post  
**LSF 1120**  
EWS 520

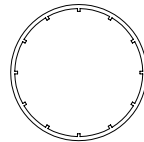

Bay pole  
**EWS 109**

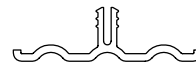

Structural butt joint trim  
**EWS 128**



T capping section  
**EWS 107**

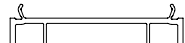

25mm frame extension  
**LSF 1106**

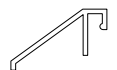

Head drip  
**LSF 1101**

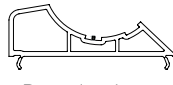

Bay pole adaptor  
**LSF 1125**

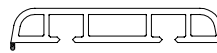

Mock transom bar  
**LSF 1119**

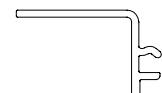

Reversible trim  
**LSF 1108**

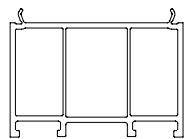

50mm frame extension  
**LSF 1126**

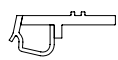

Threshold seal  
**LSF 1146**



135°-150° External angle capping  
**EWS 113**

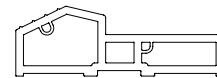

Low threshold  
**LSF 1145**

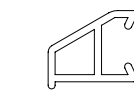

Drip bar  
**EWS 102**

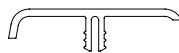

75 - 70mm adaptor  
**LSF 1110**

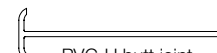

PVC-U butt joint  
**LSF 1103**

**PVC-U mouldings**

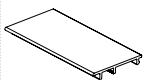

Glazing platform  
**LSF 1203**

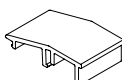

Leading ramp  
**LSF 1202**

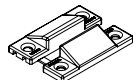

Interlocking wedges  
**EWS 7201**

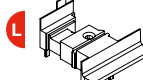

French door end cap  
**LSF 1216**

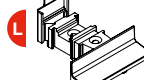

French window end cap  
**LSF 1212**

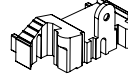

Low threshold moulding  
**LSF 1245**

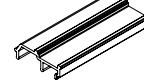

Std / slim sash French window packer  
**LSF 1213**

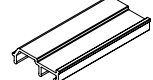

Flush sash French window packer  
**LSF 1214**

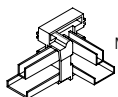

Modus S sash moulding  
**LSF 1208**

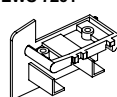

Modus S frame moulding (for use with LSF 1021 only)  
**LSF 1221**



**eurologik<sup>®</sup>**

## 70MM WINDOW AND DOOR SYSTEM

### Profile system combining energy efficiency and aesthetics with ease of fabrication

The Eurologik profile system offers leading energy efficiency performance and aesthetics. It is specially designed for ease and speed of fabrication and fitting, featuring a unique, patented knock-in bead system. Ideally suited for new-build or replacement windows, its 70mm front-to-back dimension enables the seamless replacement of timber frames.

Eurologik is designed for improved aesthetics and clean sight lines, with its unobtrusive gasket line and slim profile. The profile features multiple chambers to enhance thermal efficiency and strength, and improve drainage. Available in chamfered or sculptured ovolo styles in a range of colours, Eurologik window profiles add a touch of distinction to any property.

#### **A++ for energy efficiency**

Maximising the thermal performance of windows is vital to meet rising regulatory and customer demands. The advanced multi-chambered design of Eurologik profiles (including the optional six-chamber slim outer frame system) works to lock in heat. This means our 'A+'-rated windows offer market-leading double-glazed unit performance and value (A++ windows require triple-glazing).

#### Exceptional air tightness and weathering performance

The post co-extruded (PCE) gaskets on Eurologik profiles use a specially developed compound and twin-leg profile connection system with one-way support arm. This provides excellent adhesion to the main profiles. Tested to BS6375, the gasket system achieves outstanding air tightness and weathering performance, improving energy efficiency further by minimising air leakage.



### **The sustainable option**

Eurologik features post-consumer recycled PVC-U in the central core of the profile with 100% virgin PVC-U external faces. This ensures the same aesthetics and technical performance as other systems, but with more environmentally responsible benefits – at no extra cost.





**eurologik<sup>®</sup>**

70MM WINDOW AND DOOR SYSTEM



## PRODUCT RANGE



Chamfered casement windows



Tilt & turn windows



French windows



Residential doors

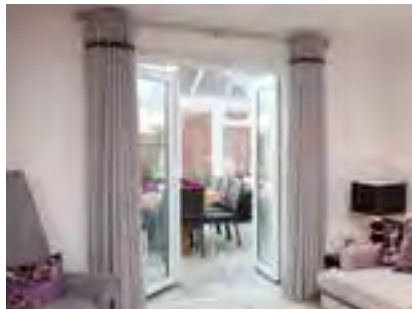

French doors



Ovolo sculptured casement windows

## FEATURES AND BENEFITS

- ▶ Independently certified by the BBA – so you can specify with confidence.
- ▶ Single reinforcement bar in main frames and transoms – for extra strength.
- ▶ Continuous reinforcement across all reverse butt-welded joints for added rigidity.
- ▶ Six-chamber design available for outstanding thermal performance, drainage and strength in the slimmest profiles.
- ▶ Integral capillary groove on all inward-facing frames to prevent water damage.
- ▶ Easy-clean internal rebates to keep windows looking their best.
- ▶ Extensive range of ancillaries, including cills, angles, bay posts and adaptors.
- ▶ Full depth eurogroove for maximum hardware compatibility.
- ▶ System accepts both 28mm and 36mm glazing thicknesses.
- ▶ Fully bevelled for a slim visual profile and clean sight lines.
- ▶ Single hinge and espagnollette location in sashes for ease of fabrication.
- ▶ PCE gaskets offer market-leading adhesion, air tightness and weather performance.
- ▶ Unique patented knock-in bead system available with 28mm and 36mm putty line.



**eurologik®**

## 70MM WINDOW AND DOOR SYSTEM

### **Energy efficiency and thermal performance**

Eurologik helps architects, builders and homeowners to meet their environmental objectives – without having to pay a premium for going green.

### **A++ performance**

A++ Window Energy Ratings (WER) are achievable with Eurologik – offering market-leading window performance using argon gas-filled glazing units. Eurologik is capable of an A+13 rating (double-glazed) and an A++20 rating (triple-glazed). What's more, U-values as low as 1.2 can be achieved with a double-glazed unit and 0.8 with a triple-glazed unit.

### **PVC-U Thermal Inserts**

PVC-U Thermal Inserts for Eurologik profiles are the sustainable way to improve your window energy efficiency. The multi-chambered design delivers significantly improved thermal performance, more efficient fabrication and 20% lighter weight than windows with conventional steel reinforcements.

Fitting Eurocell PVC-U Thermal Inserts in Eurologik profiles to boost the thermal efficiency of your windows provides better value than steel alternatives. And they are made from 100% recycled material.

\* Source: Energy Saving Trust.



Featured windows in Chartwell Green

## COLOUR OPTIONS

### EUROLOGIK WINDOW PROFILE STANDARD COLOUR OPTIONS

(ADDITIONAL COLOURS AND SPECIFICATIONS ARE MADE TO ORDER ON EXTENDED LEAD TIMES)



**WHITE**  
white interior



**WHITE ASH†**  
both sides



**CREAM**  
cream interior



**IRISH OAK†**  
white interior



**IRISH OAK†**  
both sides



**GOLDEN OAK**  
white interior



**GOLDEN OAK**  
both sides



**ROSEWOOD**  
white interior



**ROSEWOOD**  
both sides



**SLATE GREY\***  
white interior



**ANTHRACITE  
GREY\***  
white interior



**BLACK ASH\***  
white interior



**CHARTWELL  
GREEN†**  
white interior

† Ovolo only

\* Chamfered only

SMOOTH TEXTURE COLOURS ARE AVAILABLE TO SPECIAL ORDER

# eurologik® CASEMENT WINDOWS

OUTWARD OPENING, INWARD GLAZED – VERTICAL SECTION

## Double glazed

Thermalogik outerframe  
PVC-U Thermal Inserts Ovolo

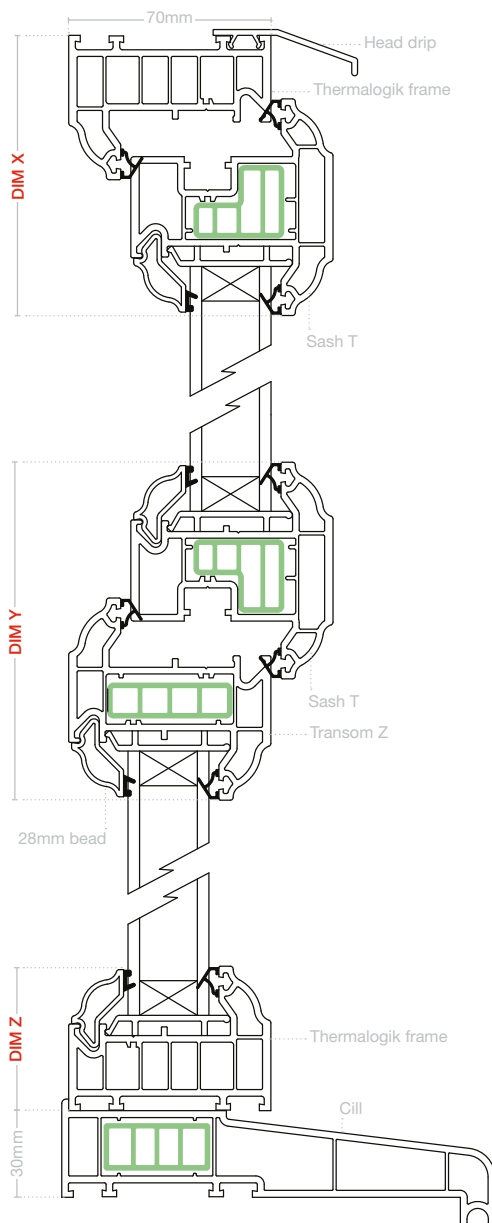

## Triple glazed

Thermalogik outerframe  
PVC-U Thermal Inserts Chamfered

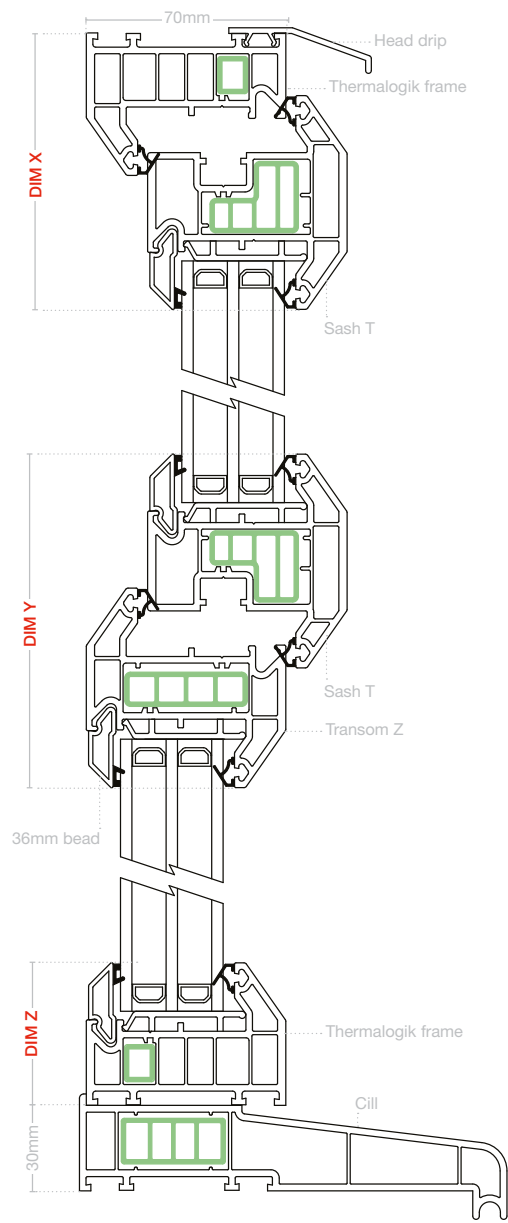

## Double glazed

Standard outerframe

PVC-U Thermal Inserts Ovolo

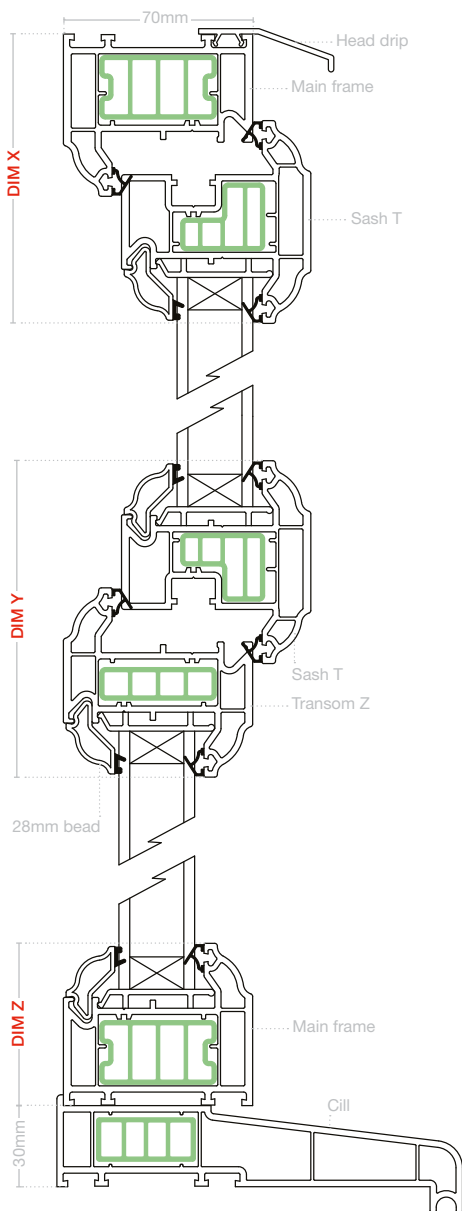

## Triple glazed

Standard outerframe

PVC-U Thermal Inserts Chamfered

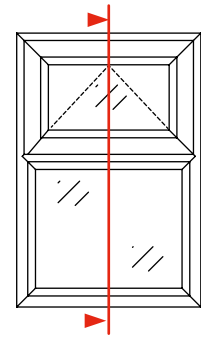
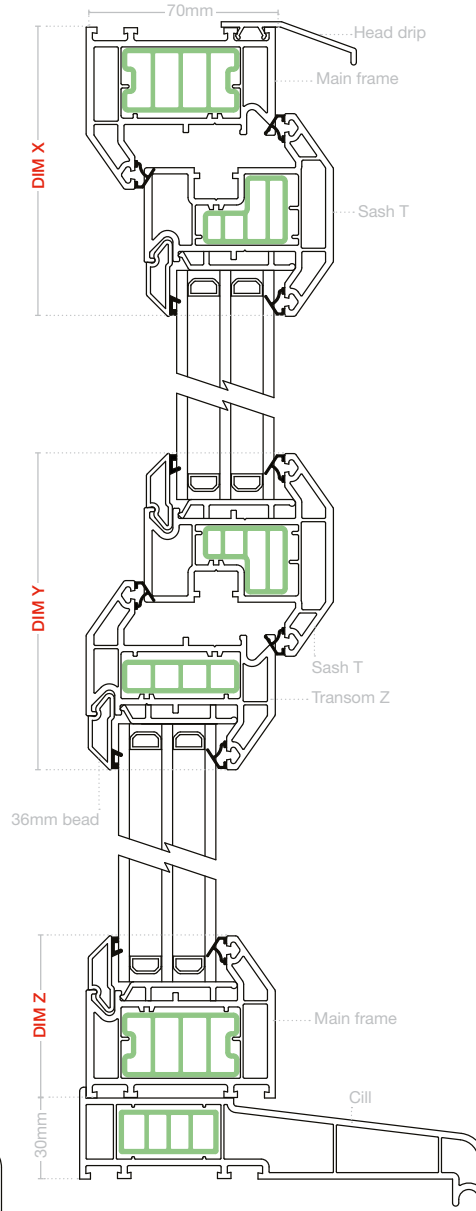

## OPTIONS

Frame	Dim X
Thermalogik frame (EWS 7001 / 7701) with Sash T (EWS 7005 / 7705)	97mm
Main frame (EWS 7021 / 7721) with Sash T (EWS 7005 / 7705)	107mm
Large main frame (EWS 7006 / 7706) with Sash T (EWS 7005 / 7705)	122mm

Frame	Dim Y
Sash T (EWS 7005 / 7705) with transom Z (EWS 7003 / 7703)	117mm
Sash T (EWS 7005 / 7705) with intermediate transom Z (EWS 7023 / 7723)	132mm

Frame	Dim Z
Thermalogik frame (EWS 7001 / 7701)	50mm
Main frame (EWS 7021 / 7721)	60mm
Large main frame (EWS 7006 / 7706)	75mm



# eurologik® TILT & TURN WINDOWS

INWARD OPENING, INWARD GLAZED – VERTICAL SECTION

## OPTIONS

Frame	Dim X
Main frame (EWS 7021 / 7721) with tilt and turn sash (EWS 7007 / 7707)	107mm
Large main frame (EWS 7006 / 7706) with tilt and turn sash (EWS 7007 / 7707)	122mm

Frame	Dim Y
Main frame (EWS 7021 / 7721) with tilt and turn sash (EWS 7007 / 7707) with all A type cills	137mm
Large main frame (EWS 7006 / 7706) with tilt and turn sash (EWS 7007 / 7707) with all A type cills	152mm

Note: technical drawings are not to scale

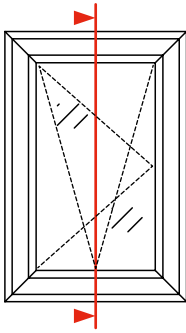

**Double glazed**  
PVC-U Thermal Inserts Ovolo

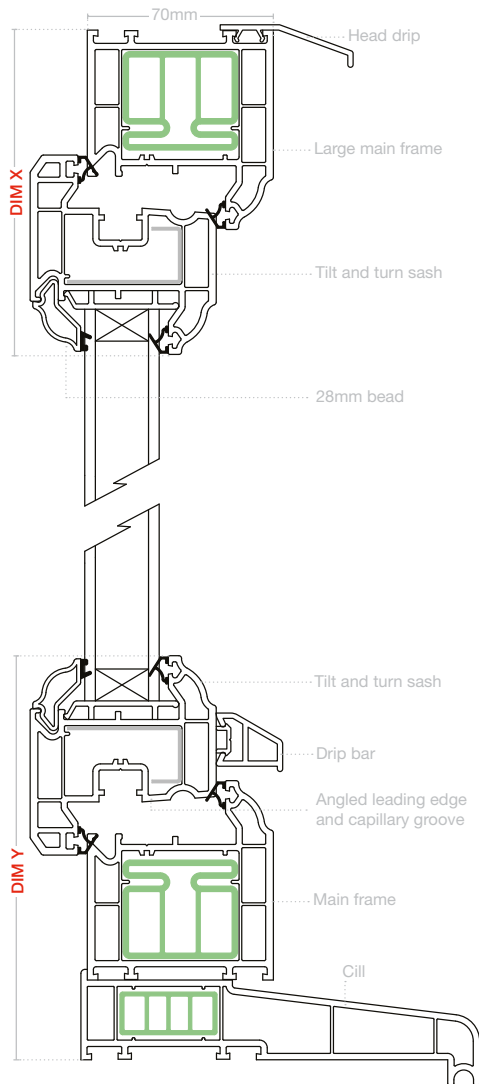

**Triple glazed**  
PVC-U Thermal Inserts Chamfered

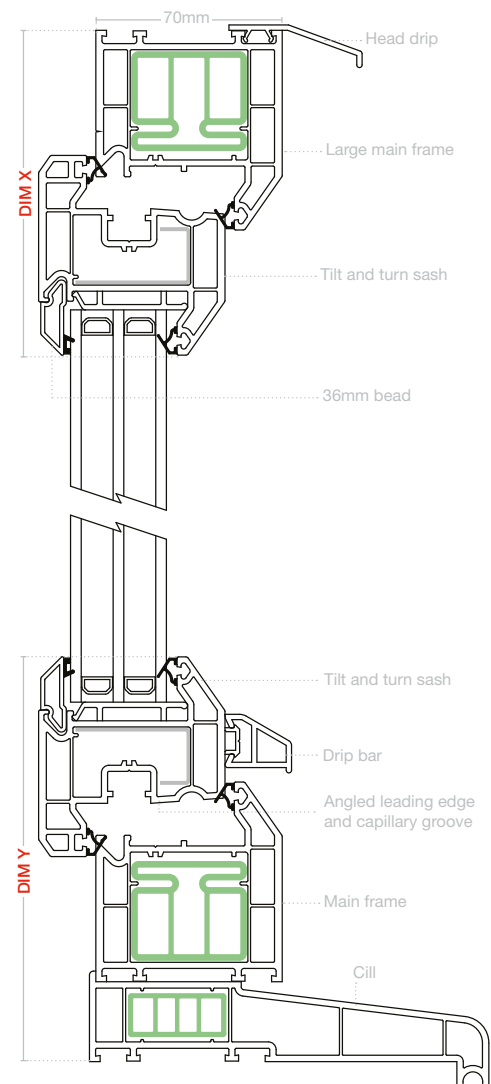

# eurologik® FRENCH & RESIDENTIAL DOORS

## INWARD GLAZED – VERTICAL SECTION

### Double glazed

#### Ovolo - Inward opening

(Chamfered also available)

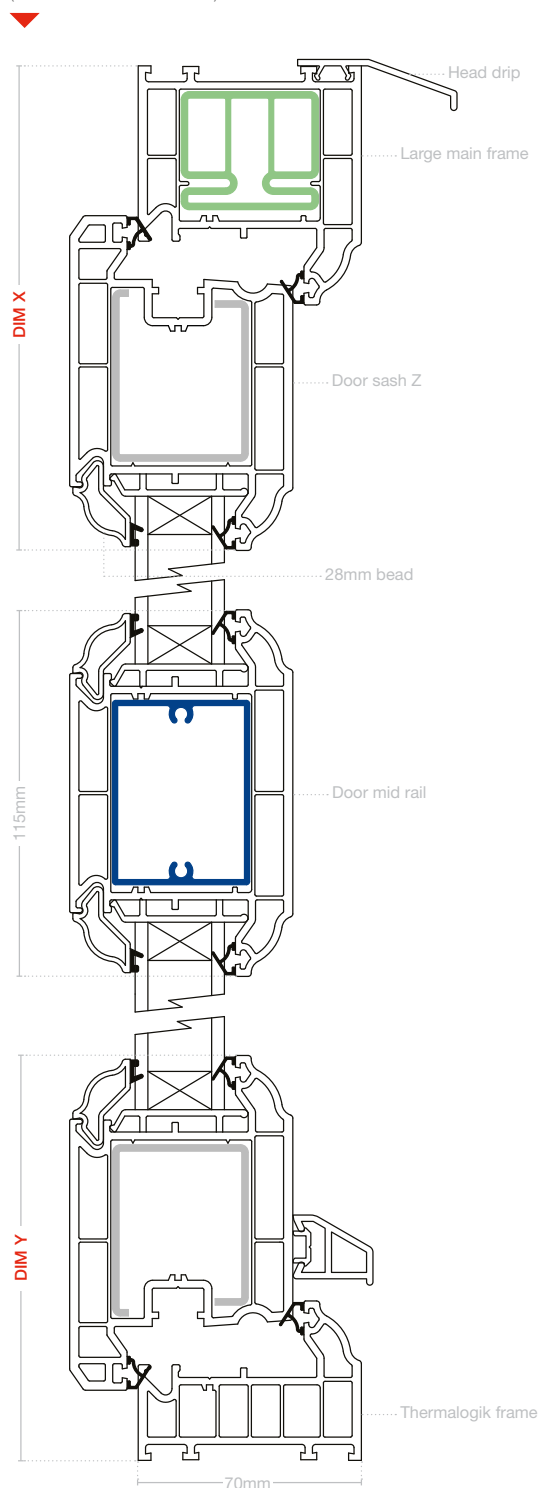

### Option

#### Part M low threshold assembly

(PVC Low threshold also available)

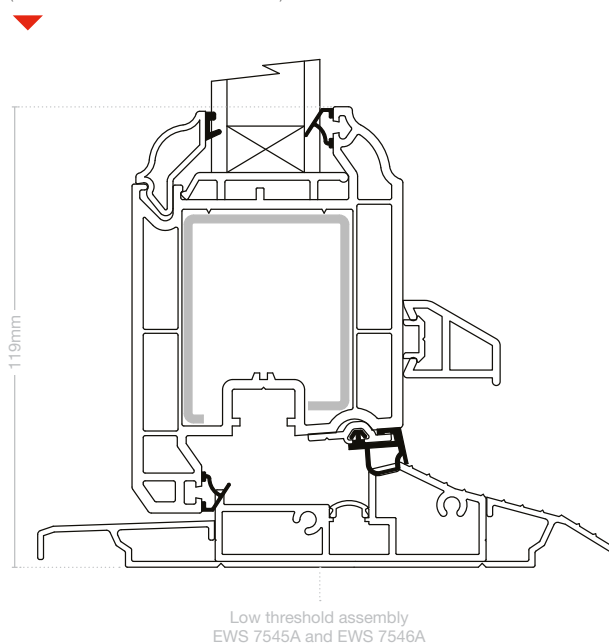

## OPTIONS

Option shown highlighted in bold

Frame	Dim X
Main frame (EWS 7021 / 7721) with door sash Z (EWS 7018 / 7718)	137mm
<b>Large main frame (EWS 7006 / 7706) with door sash Z (EWS 7018 / 7718)</b>	<b>152mm</b>

Frame	Dim Y
<b>Thermalogik frame (EWS 7001 / 7701) with door sash Z (EWS 7018 / 7718)</b>	<b>127mm</b>
Main frame (EWS 7021 / 7721) with door sash Z (EWS 7018 / 7718)	137mm
<b>Large main frame (EWS 7006 / 7706) with door sash Z (EWS 7018 / 7718)</b>	<b>152mm</b>



## Triple glazed

### Chamfered - Outward opening

(Ovolo also available)

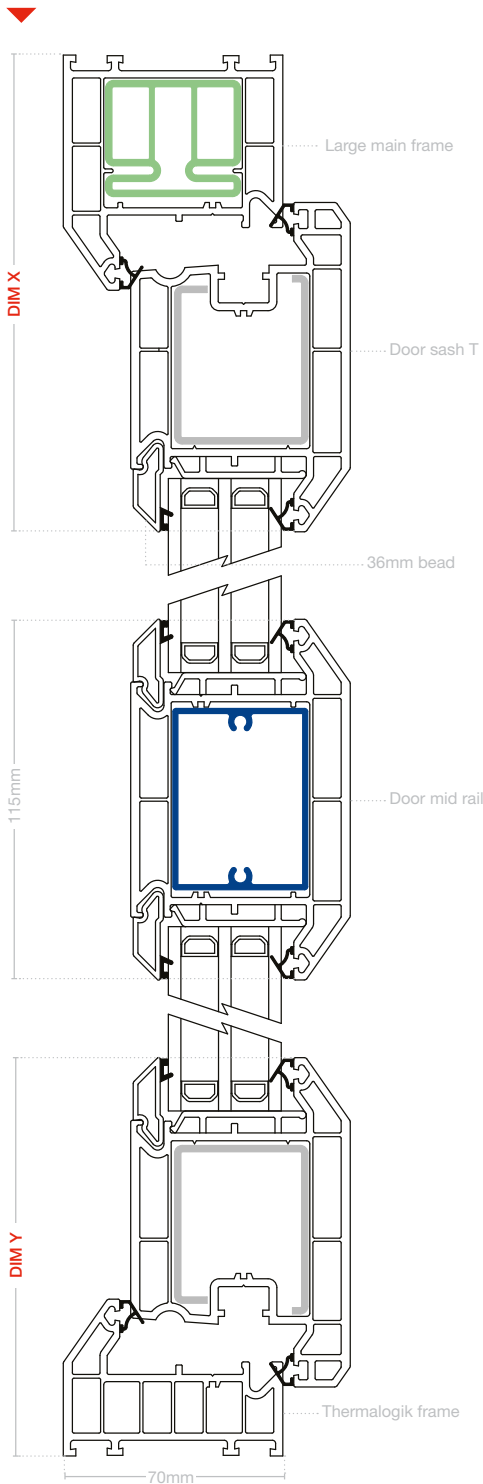

## Option

### Part M low threshold assembly

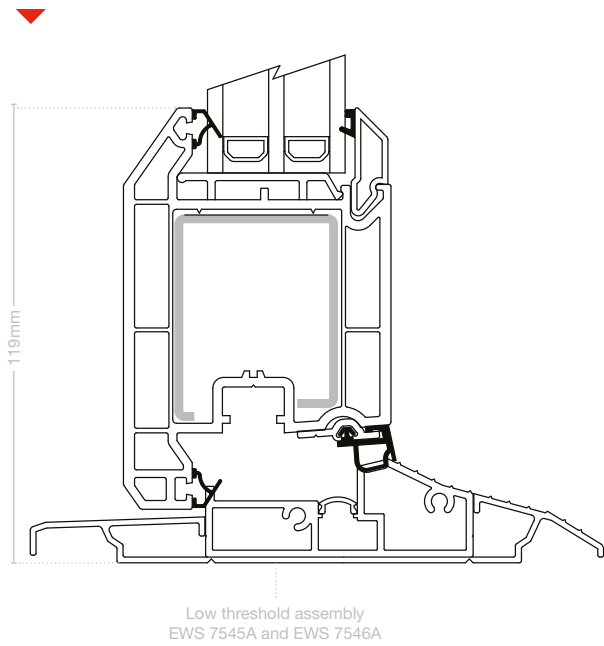

## OPTIONS

Option shown highlighted in bold

Frame	Dim X
Main frame (EWS 7021 / 7721) with door sash T (EWS 7019 / 7719)	137mm
<b>Large main frame (EWS 7006 / 7706) with door sash T (EWS 7019 / 7719)</b>	<b>152mm</b>

Frame	Dim Y
<b>Thermalogik frame (EWS 7001 / 7701) with door sash T (EWS 7019 / 7719)</b>	<b>127mm</b>
Main frame (EWS 7021 / 7721) with door sash T (EWS 7019 / 7719)	137mm
Large main frame (EWS 7006 / 7706) with door sash T (EWS 7019 / 7719)	152mm



**eurologik® FRENCH DOORS**

OUTWARD OPENING, INWARD GLAZED – HORIZONTAL SECTION

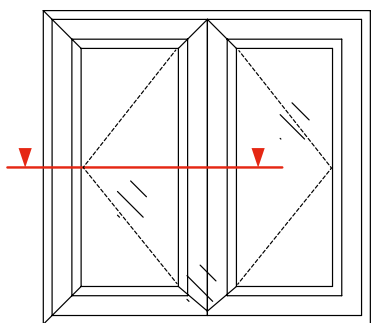

**Double glazed**  
PVC-U Thermal Inserts Ovolo

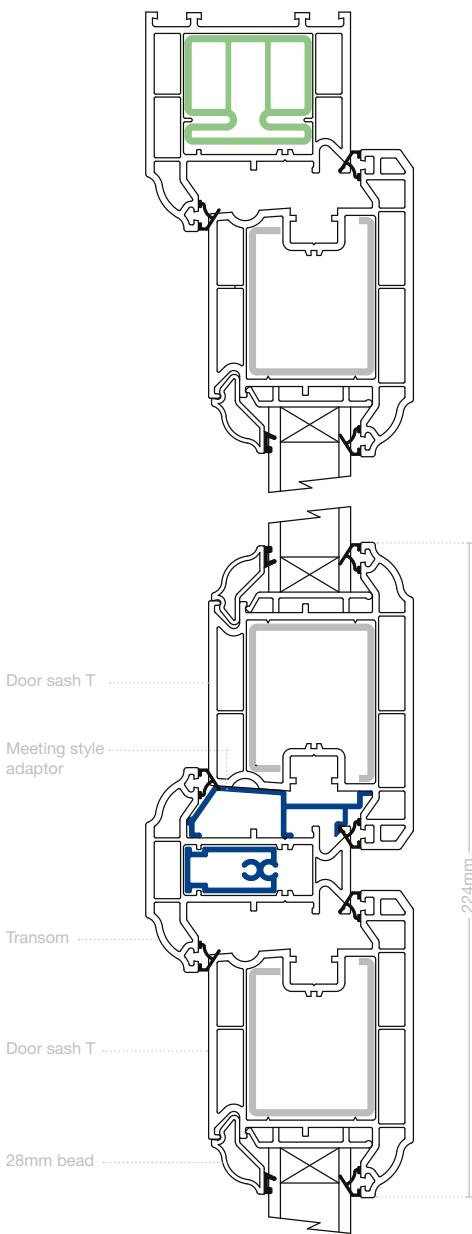

**Triple glazed**  
PVC-U Thermal Inserts Chamfered

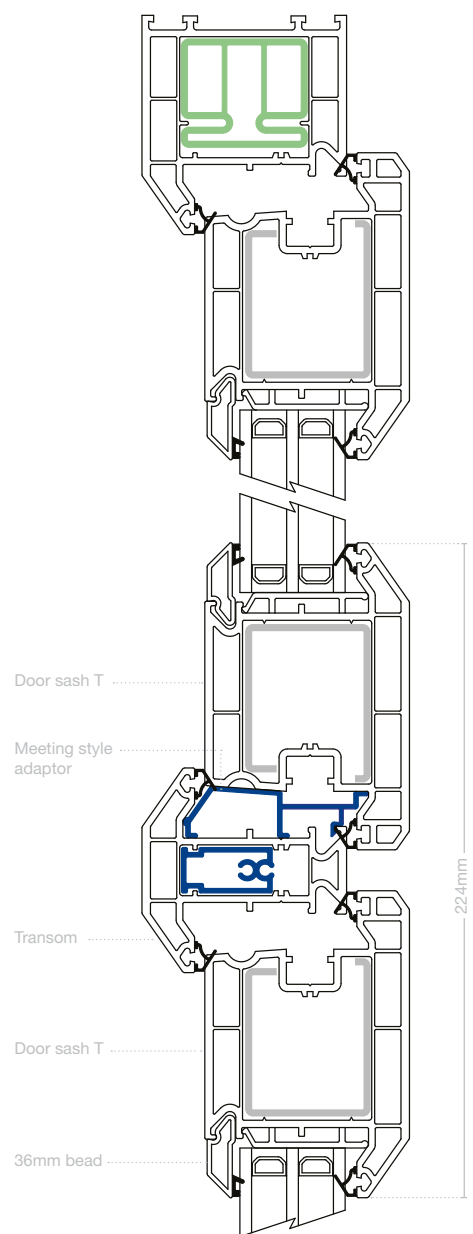



# eurologik® JOINTS

VARIOUS JOINT ASSEMBLIES

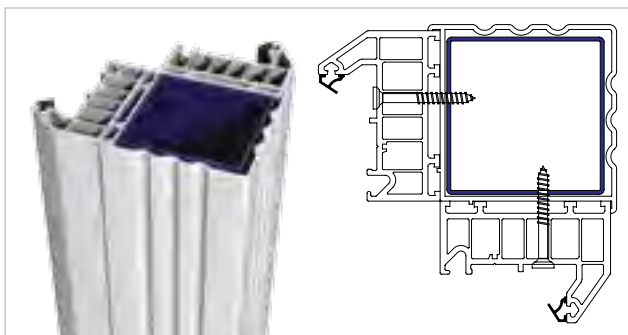

**70mm decorative square bay  
post assembly 90° angle**

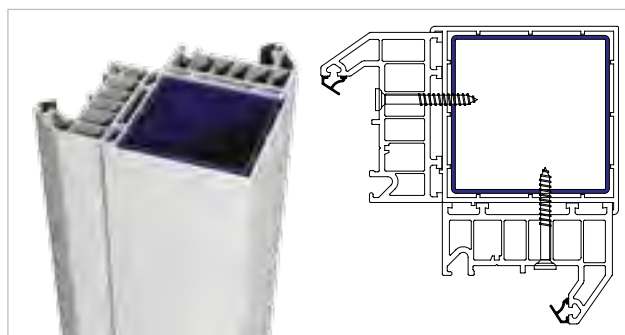

**70mm square bay post assembly  
90° angle**

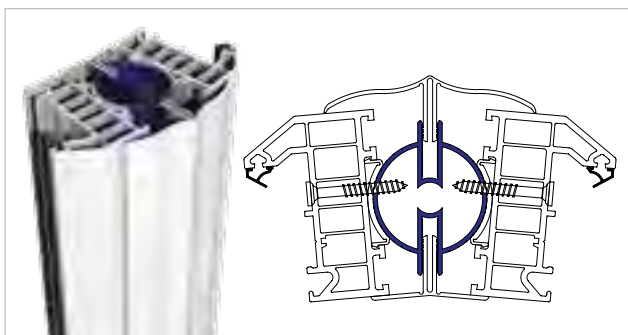

**Variable bay post assembly  
120-150° angles**

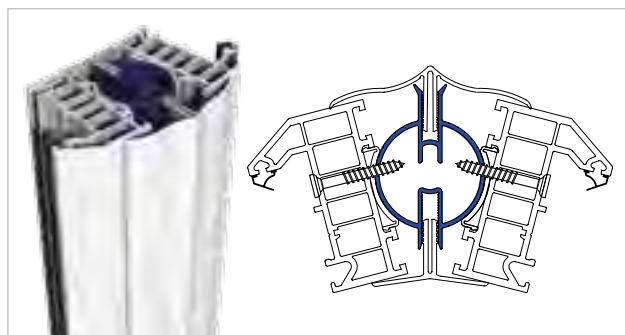

**Variable bay post assembly  
150-170° angles**

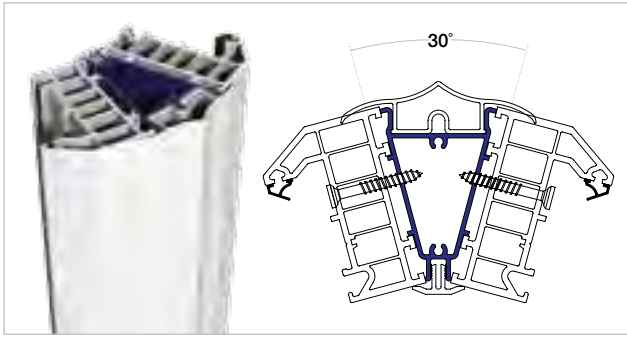

**Bay post assembly**  
150° angle

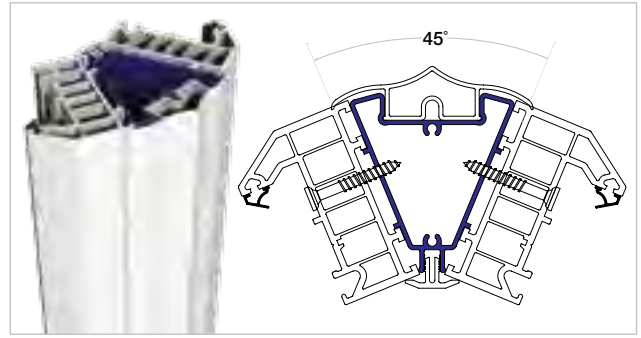

**Bay post assembly**  
135° angle

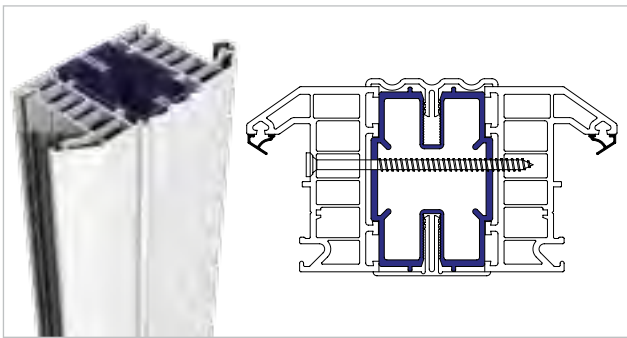

**Structural butt joint assembly**  
with sculptured trim

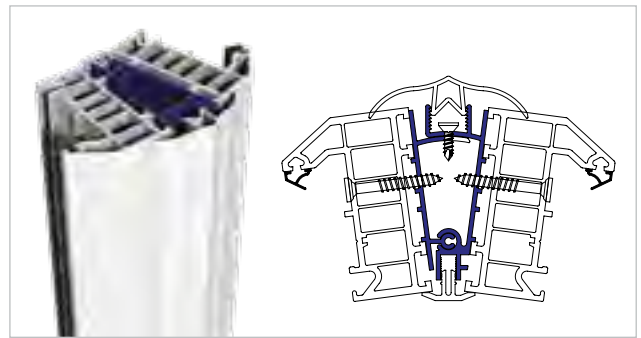

**Variable angle bow post assembly**  
160-170° angle

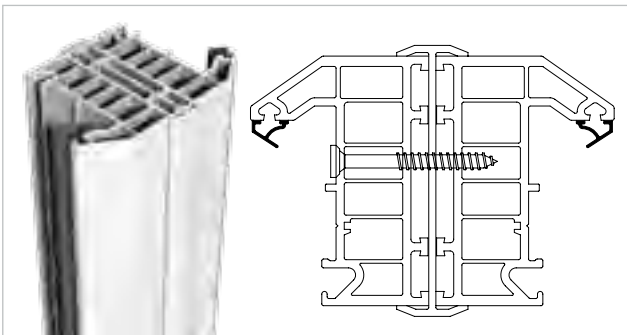

**PVC-U butt joint assembly**

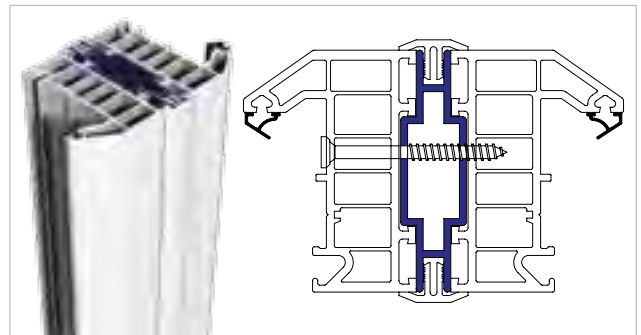

**Aluminium butt joint assembly**

A RANGE OF BAY JACKS ARE AVAILABLE FOR SOME OF THESE PRODUCTS

The Eurocell range of external cills and end caps are available in three sizes and are colour matched to a wide range of window systems within the industry. External cills are multi-chambered profiles are designed to take an imposed vertical load of up to four tonnes.

### WINDOW CILLS

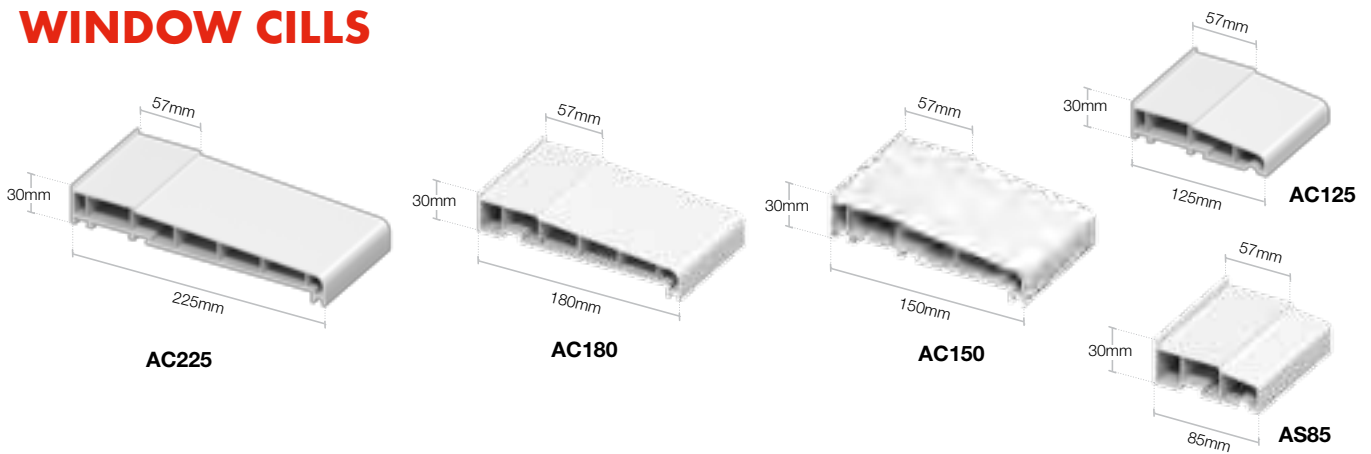

### JOINTS, TRIMS AND REINFORCEMENTS

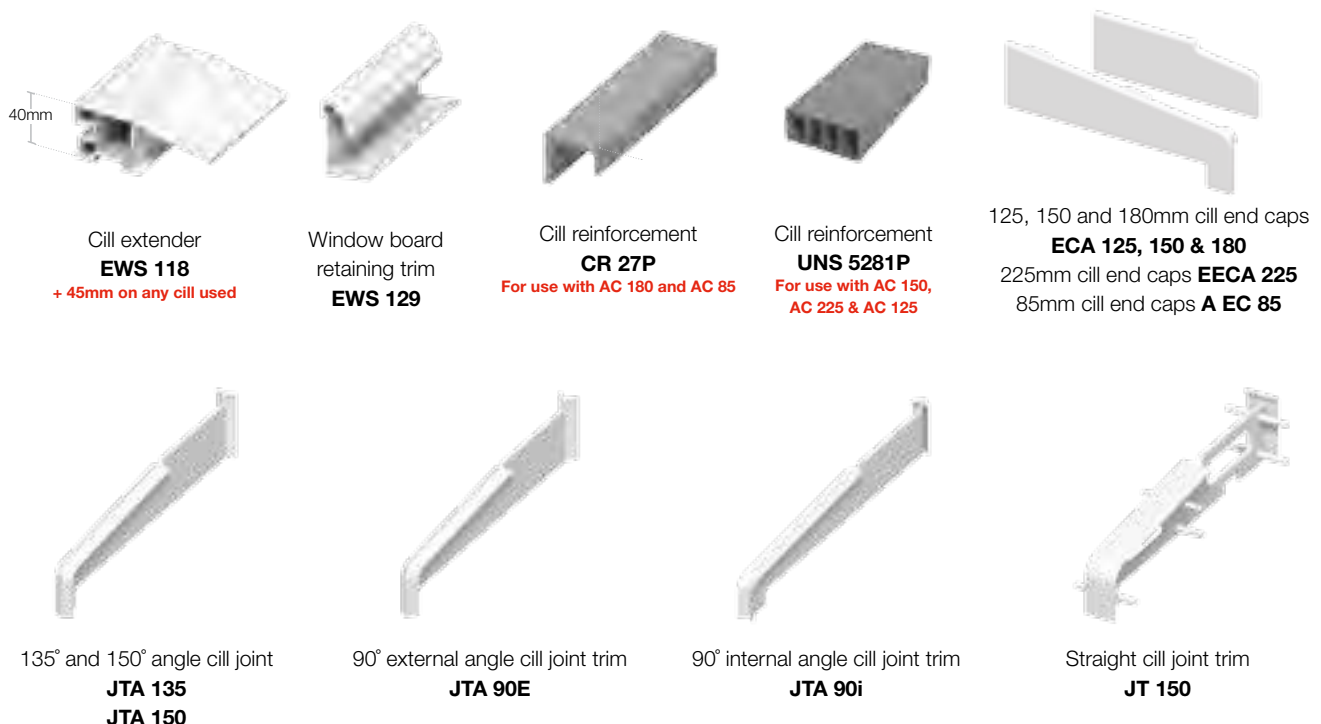

## FINISHING TRIM SCENARIOS



6mm pencil round architrave (flatback) in Rosewood



Foam quadrant in Golden Oak finish



9mm capping board used as a reveal liner



9mm window board with end cap



9mm capping board with end cap, used as an internal window sill

Eurocell offers a comprehensive range of window finishing trims in foam and rigid options, providing the complete package for smart window presentation

### Architraves

Where plaster damage is minimal, the foam architraves are available in either 6mm or 9mm thickness. These trims can be fixed with adhesive tapes or silicone, with the latter needing support until it has cured.

### Window finishing trims

Similar to the architraves, these products offer an alternative finishing option around the windows.

### Window boards

Available in a 9mm thickness, a capping or window board provides a square or half round finish. These products can be secured to existing window boards by using an adhesive.

### PLUS!

Window finishing trims are available from Eurocell Building Plastics branches nationwide. To find your nearest branch, visit [eurocell.co.uk/branchfinder](http://eurocell.co.uk/branchfinder)

### MAIN PROFILES

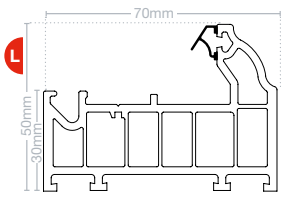

Thermalogik frame  
**EWS 7701**  
Reinforcing EWS 800P

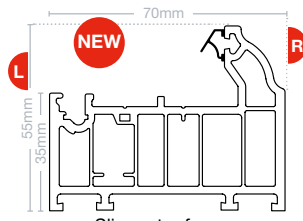

**NEW**  
Slim outer frame  
**EWS 7720**  
Reinforcing EWS 800P

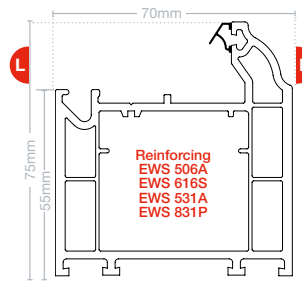

Large main frame **EWS 7706**

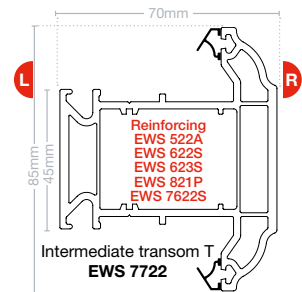

Reinforcing  
EWS 522A  
EWS 623S  
EWS 821P  
EWS 7622S  
Intermediate transom T  
**EWS 7722**

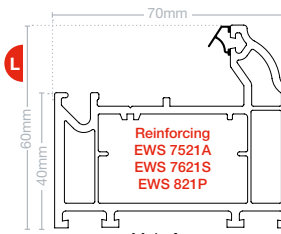

Main frame  
**EWS 7721**

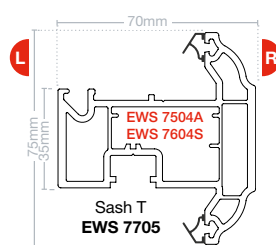

EWS 7504A  
EWS 7604S  
Sash T  
**EWS 7705**

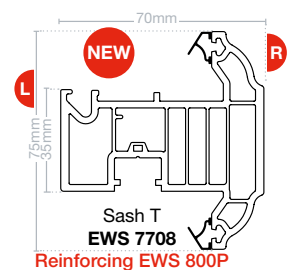

**NEW**  
Sash T  
**EWS 7708**  
Reinforcing EWS 800P

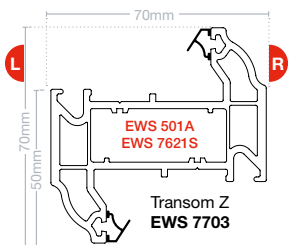

EWS 501A  
EWS 7621S  
Transom Z  
**EWS 7703**

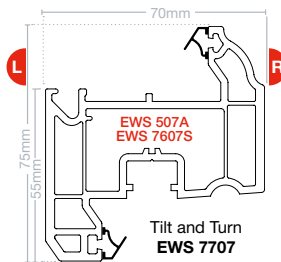

EWS 507A  
EWS 7607S  
Tilt and Turn  
**EWS 7707**

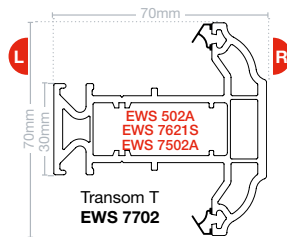

EWS 502A  
EWS 7621S  
EWS 7502A  
Transom T  
**EWS 7702**

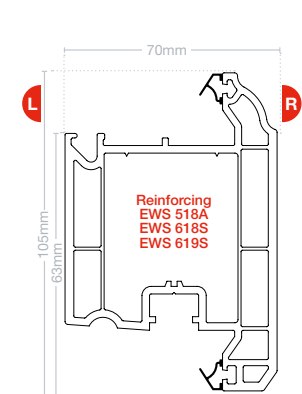

Reinforcing  
EWS 518A  
EWS 618S  
EWS 619S  
Door sash T  
**EWS 7719**

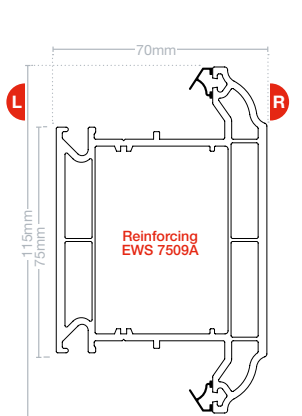

Reinforcing  
EWS 7509A  
Door mid rail  
**EWS 7709**

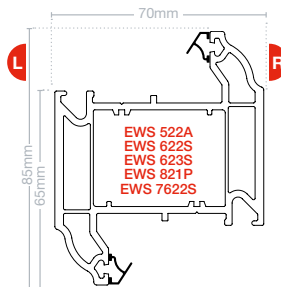

EWS 522A  
EWS 622S  
EWS 623S  
EWS 821P  
EWS 7622S  
Intermediate transom Z  
**EWS 7723**

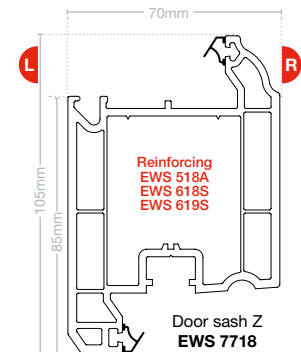

Reinforcing  
EWS 518A  
EWS 618S  
EWS 619S  
Door sash Z  
**EWS 7718**

### STEEL COMPONENTS

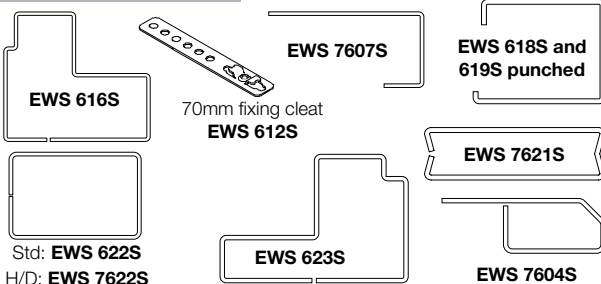

### DEC FEATURES

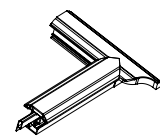

Mock sash horn kit  
**EWS 7902**



Arch top inserts  
**EWS 7912** to be used  
with EWS 7705 and 7312

### PVC-U THERMAL INSERTS

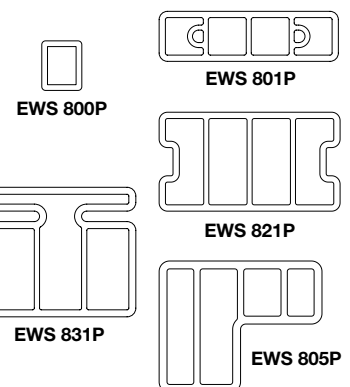



## ANCILLARIES, BEADS & GASKETS

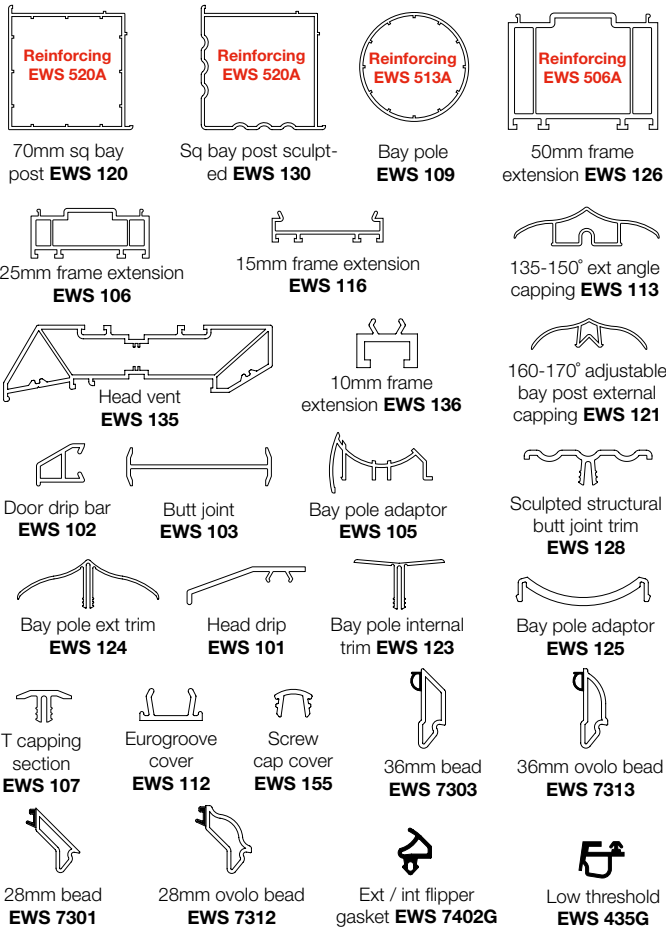

## CILLS, ANGLES & TRIMS

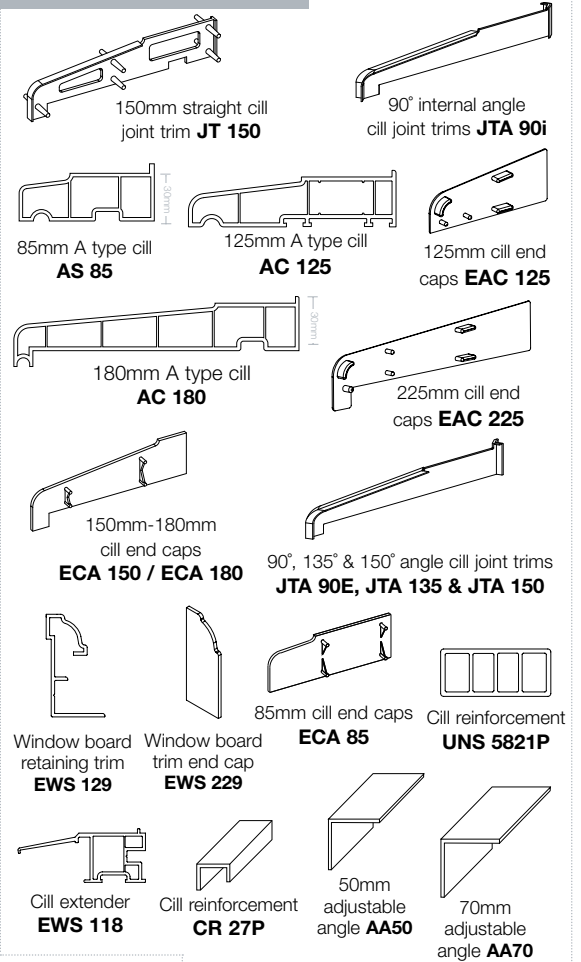

## MOULDINGS

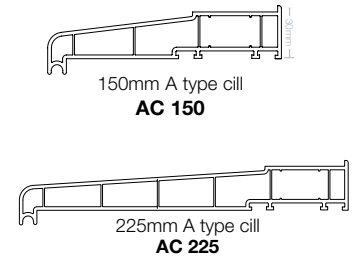

## ALUMINIUM COMPONENTS

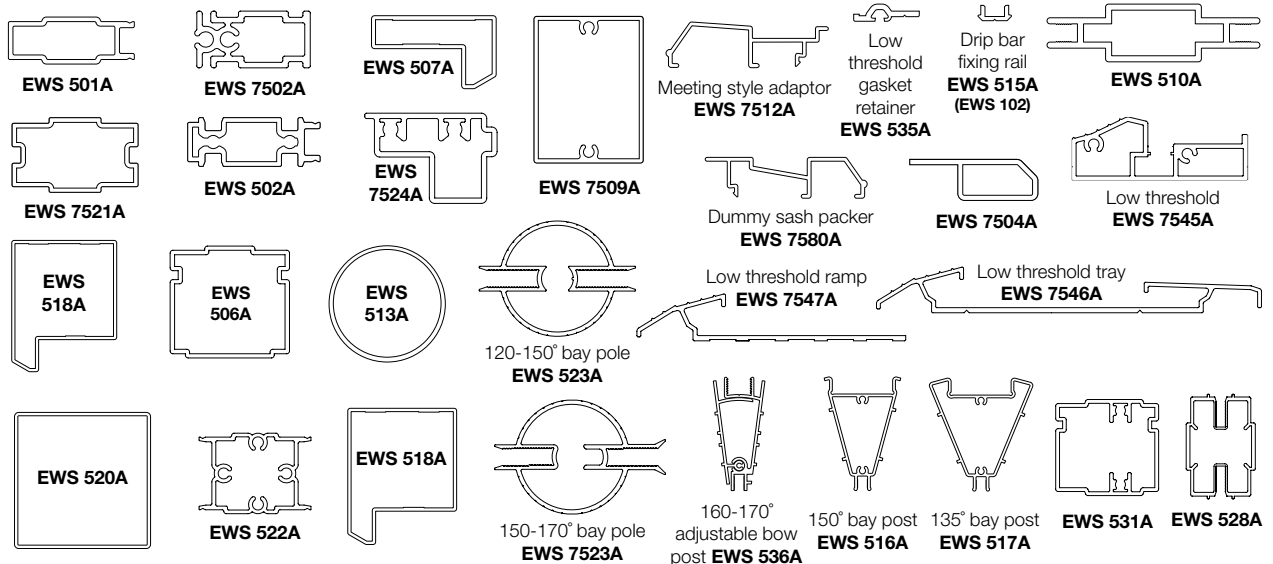

Note: drawings not to scale. The product codes of the main frames on this chart are for the post-consumer recycled PVC-U version of eurologik. The 100% virgin PVC-U products are available to order on separate codes. For more details, please contact the Customer Care Team on 01773 842222 or email [customer@eurocell.co.uk](mailto:customer@eurocell.co.uk)

### MAIN PROFILES

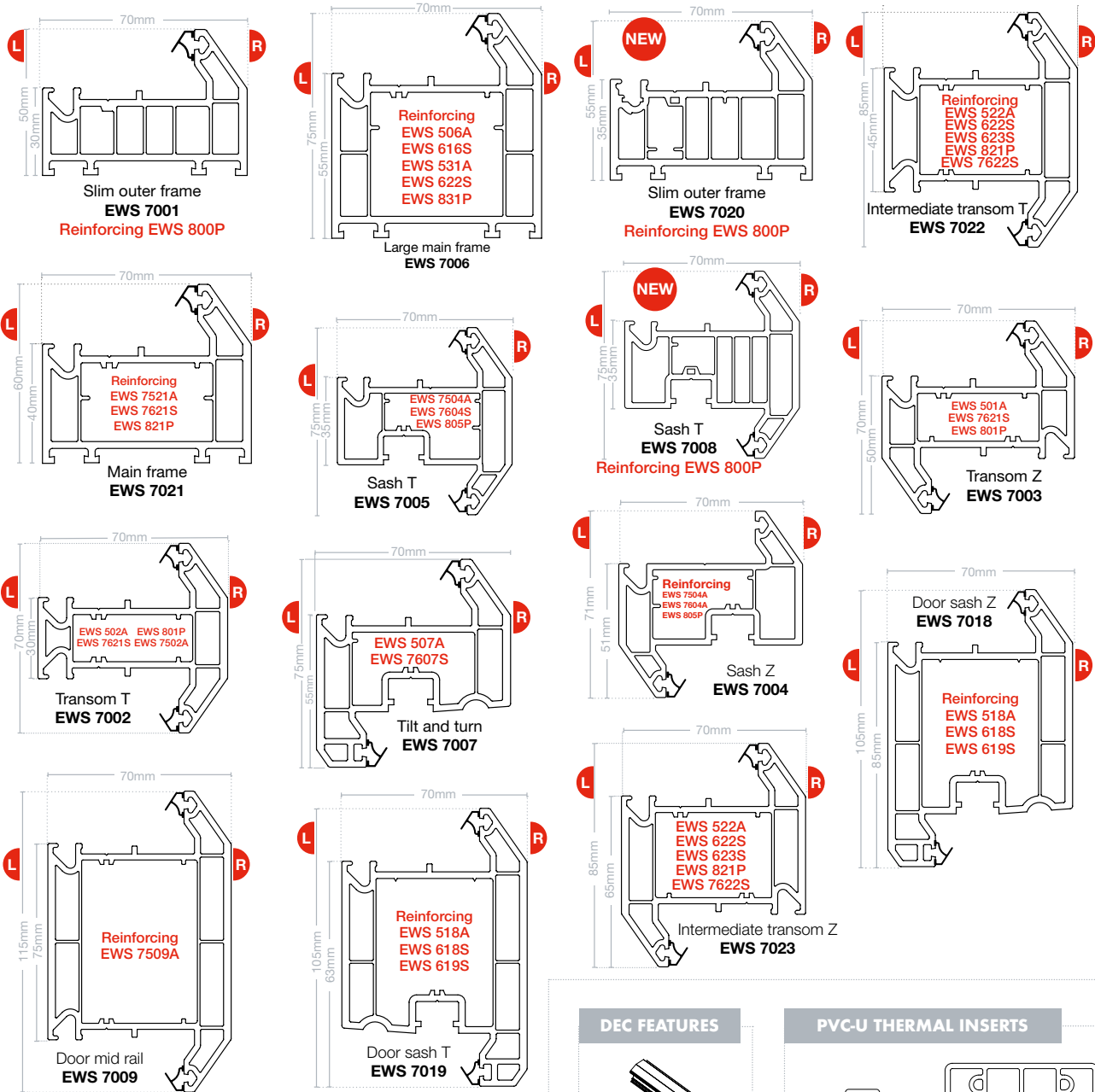

### STEEL COMPONENTS

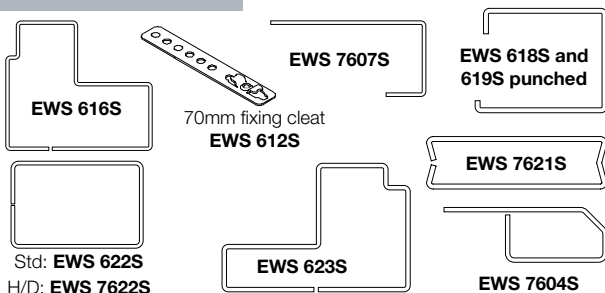

### DEC FEATURES

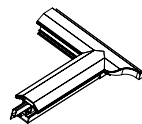

Mock sash horn kit  
EWS 7902



Arch top inserts  
EWS 7912 to be used  
with EWS 7705 and 7312

### PVC-U THERMAL INSERTS

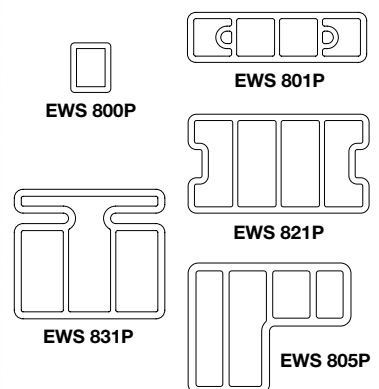

## ANCILLARIES, BEADS & GASKETS

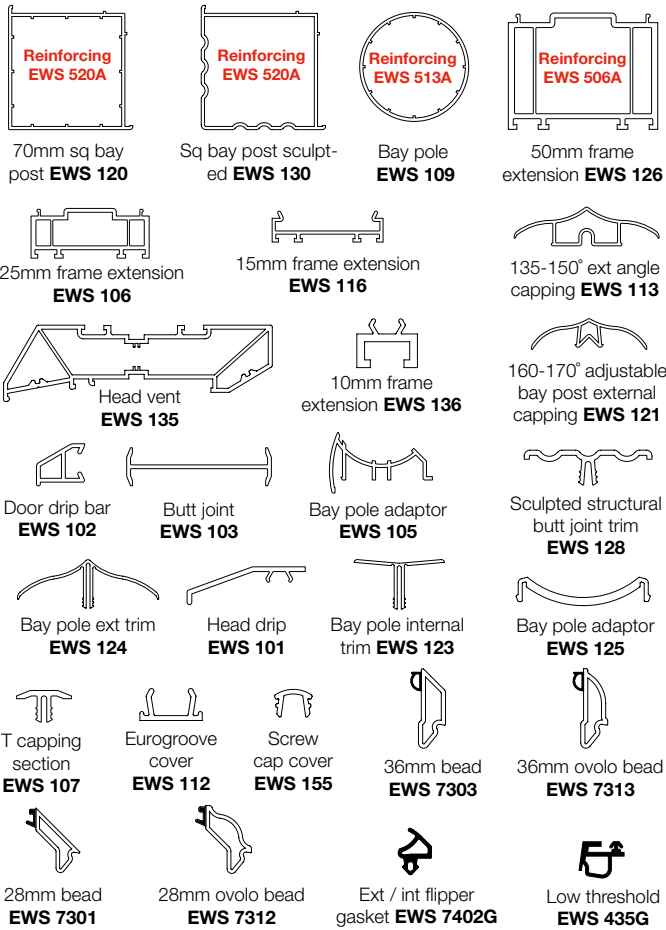

## CILLS, ANGLES & TRIMS

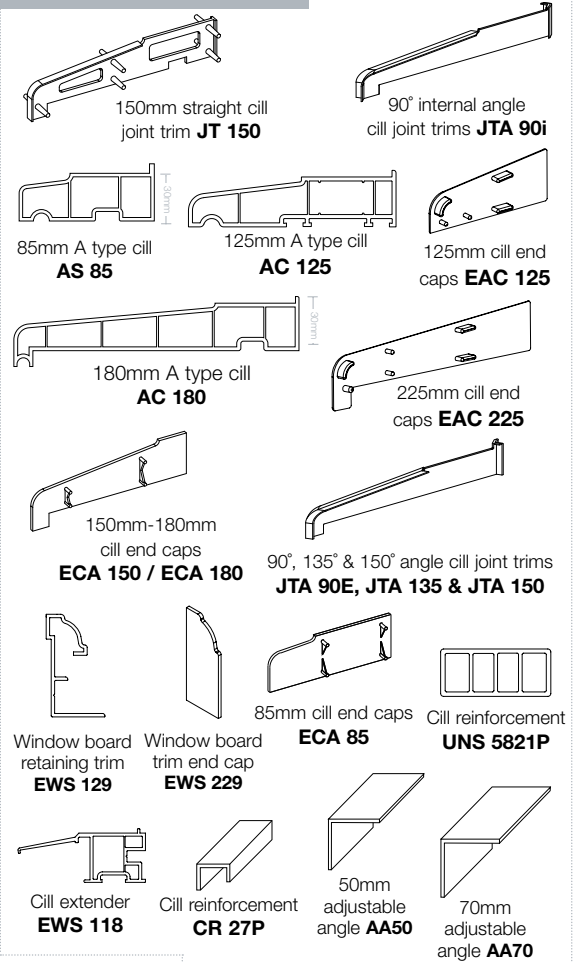

## MOULDINGS

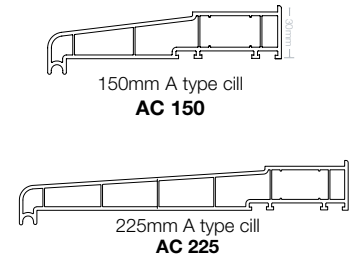

## ALUMINIUM COMPONENTS

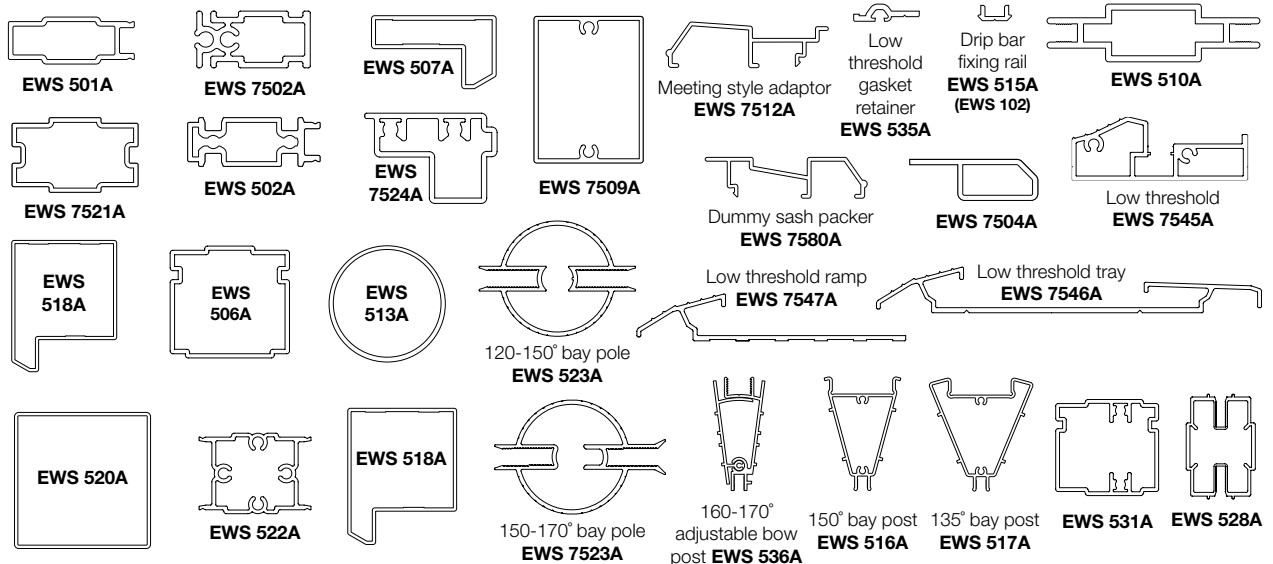



**charisma<sup>®</sup>**

## VERTICAL SLIDING SASH WINDOWS

### The ultimate combination of classic design with 21st century PVC-U engineering

The Eurocell Charisma vertical sliding sash window system enables you to achieve classically styled traditional windows with all the low-maintenance and thermal efficiency benefits of PVC-U.

As one of the most highly engineered vertical sliding windows on the market, it captures the stylish looks of the Georgian era, with none of the associated problems of draughts, rattling sashes and high maintenance.

Plus, we now offer Charisma classic – an extension to the Charisma range designed to meet the exacting requirements of conservation areas and historic buildings. It boasts enhanced aesthetics, including a deep bottom rail and unique design run-through horns.

### Faultless fabrication – every time

This market-leading product has been updated to improve its aesthetics and make the entire system even quicker and simpler to fabricate and install. Precision-machined components mean you can now supply customers with a technically advanced, high-performance window that's fabricated to the same high standard every time.

You also have the reassurance that our vertical sliding sash window is manufactured to BSI quality standards for PVC-U profile, and is BBA approved.



## Appealing classical aesthetics

The system's superior aesthetics are achieved with a combination of slim sightlines and attention to styling details. Optional ovolo Georgian bars and ovolo crash stops co-ordinate with the sculpted frames to give a classic cottage look, which is enhanced by decorative horns.

Unique slot-in end caps for Georgian bars and security bars are sculpted to fit flush with the window frame, removing any need for difficult and time-consuming milling. We have also developed a unique Georgian bar cruciform moulding to create a neat finish at the crossing point of vertical and horizontal bars.

Such attention to detail means that every homeowner choosing a Eurocell Charisma window gets the same premium quality, precision-finished and artistically styled window.



**charisma<sup>®</sup>**

## VERTICAL SLIDING SASH WINDOWS

### **Energy efficiency and thermal performance**

The three-chambered PVC-U profile of the Charisma window system offers excellent thermal insulation, while triple brush seals around the openings deliver outstanding draught-proofing.

Eurocell vertical sliders may have a traditional look, but their environmental performance is right up to date – offering exceptional energy efficiency and draught-proofing for 'A+'-rated performance. That's great news for consumers looking to reduce their energy bills.

The Eurocell Charisma vertical sliding sash window system can achieve U-values as low as 1.2.

### **Innovative PVC-U Thermal Inserts**

PVC-U Thermal Inserts for Charisma vertical sliding sash windows are the sustainable way to further improve window energy efficiency.

The multi-chambered design delivers significantly improved thermal performance, more efficient fabrication and 20% lighter weight than windows with conventional steel reinforcements.

Plus, PVC-U Thermal Inserts are manufactured using 100% post-consumer recycled material. That means the entire window frame is recyclable – making it quicker and simpler to re-use post-consumer windows.

Note: Charisma profiles can also be reinforced with steel or aluminium.

## FEATURES AND BENEFITS

- ▶ Independently certified by the BBA – so you can specify with confidence
- ▶ 125mm front-to-back dimension
- ▶ 24mm glazing units
- ▶ Window sizes up to 1600mm (w) x 2400mm (h)
- ▶ Tilt-and-slide mechanism for easy cleaning of outer panes from inside the building
- ▶ Choice of galvanised steel reinforcements, aluminium reinforcements or PVC-U Thermal Inserts
- ▶ Internal webs provide maximum stability and impact resistance
- ▶ Anti-jemmy security bar and high-security locks prevent break-ins
- ▶ Multi-chambered profile systems – for exceptional thermal efficiency
- ▶ Triple brush seals for superior draught proofing
- ▶ Overhead vent for year-round fresh air



## COLOUR OPTIONS

### CHARISMA WINDOW PROFILE COLOUR OPTIONS:

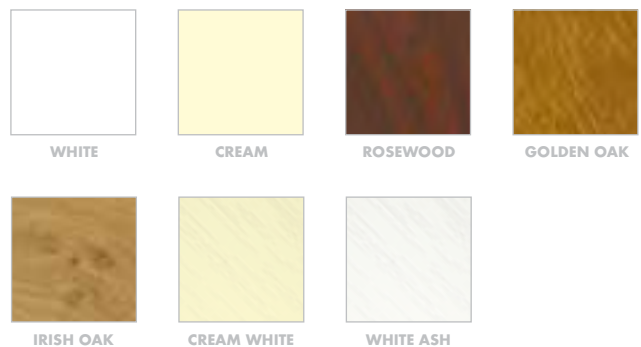

Other colours are available for special order on extended lead times.



**charisma<sup>®</sup>**

## VERTICAL SLIDING SASH WINDOWS

### KEY FEATURES

#### **Superior ventilation – for year-round fresh air**

The Charisma vertical sliding sash window system has been designed to offer superior ventilation. Both top and bottom sashes can be partially opened, encouraging fresh air to enter the building at the bottom of the window while warm, stale air escapes at the top. It means that air is able to circulate constantly, keeping rooms fresh and comfortable. The window also features an overhead vent, allowing fresh air to flow all year round without compromising security.

#### **Tilt-and-slide action for easy maintenance**

As well as sliding up and down, both sashes in the window also tilt inwards. This innovative slide-and-tilt slide mechanism means that the outer glass panes can be cleaned safely and easily from within the building.

#### **Safe and secure**

Security is a major concern for all homeowners, and the Eurocell Charisma window has been specially designed to keep intruders at bay. It features a tough aluminium anti-jimmy bar to prevent the sash from being levered open, as well as a choice of high-security locks.

The windows offer excellent fire safety too, as a large enough opening can be created to use as a means of escape, in line with the requirements of Building Regulations Part B (fire safety).



## DECORATIVE OPTIONS

Choose from a range of design features to suit every property:



Slot-in end caps



Cruciform moulding



Sash lock



Ovolo sculpted cill



Infill trim



(Charisma classic) unique-design decorative horns



Deep bottom rail for Charisma classic

## INWARD GLAZED – VERTICAL SECTION

### Double glazed PVC-U Thermal Inserts

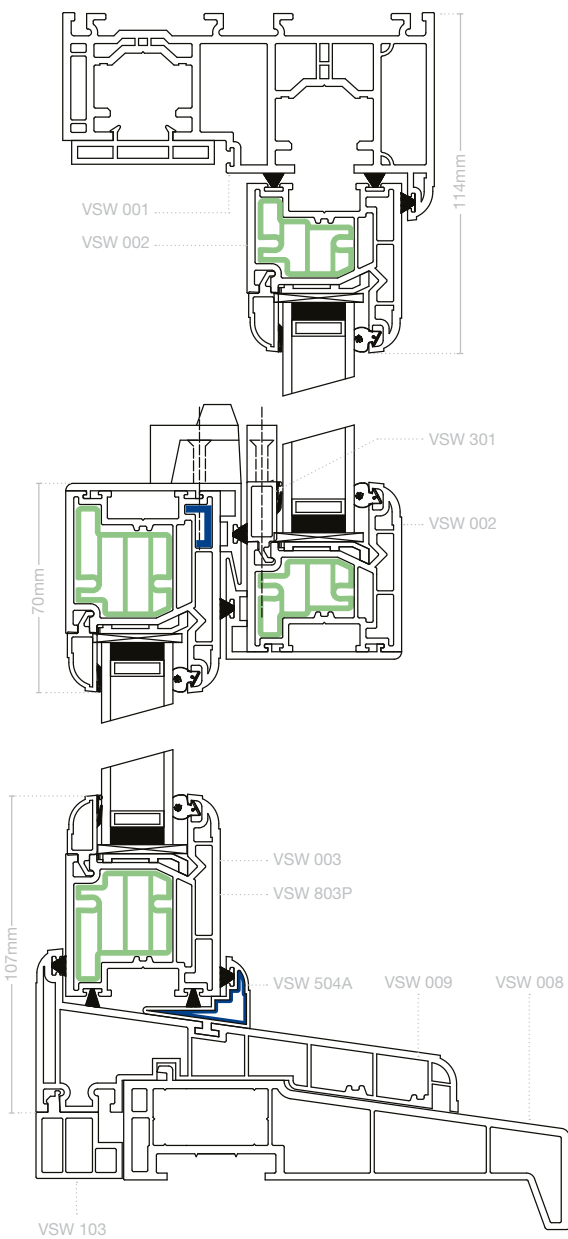

### Double glazed Steel / aluminium

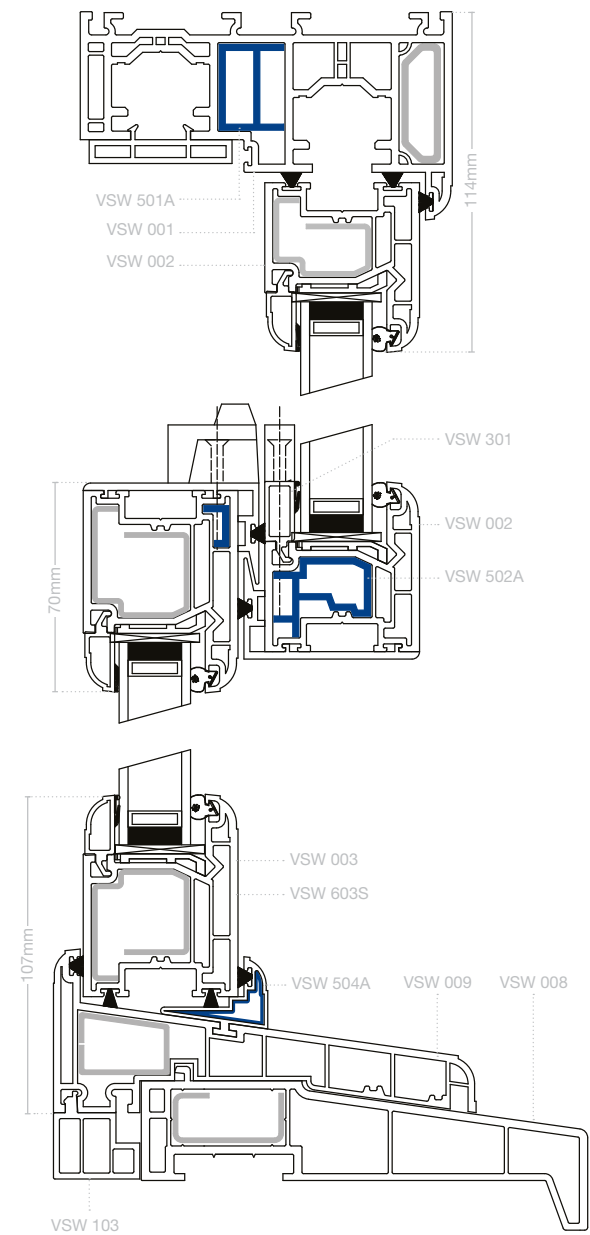

# charisma<sup>®</sup> CLASSIC

## INWARD GLAZED – VERTICAL SECTION

### Double glazed PVC-U Thermal Inserts

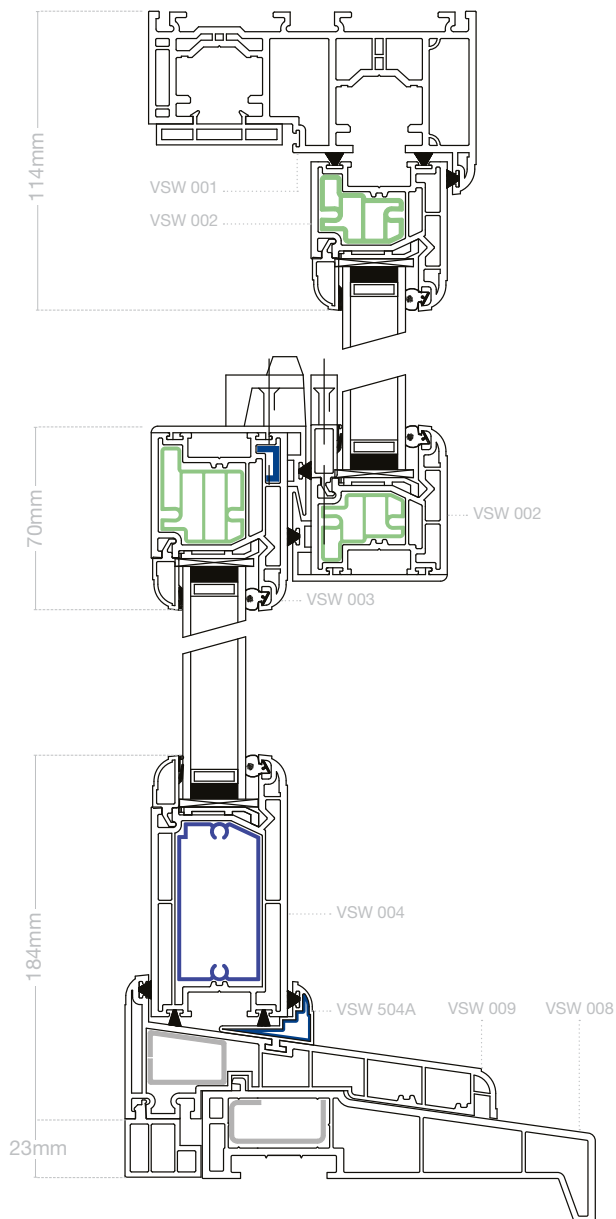

### Double glazed Steel / aluminium

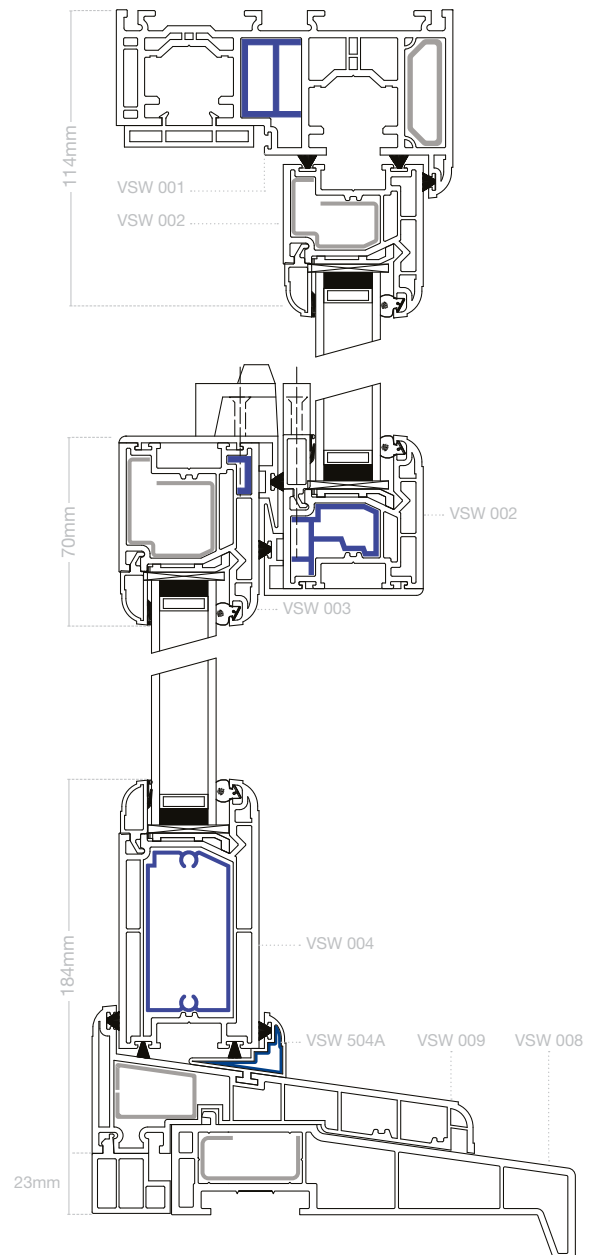

### MAIN PROFILES

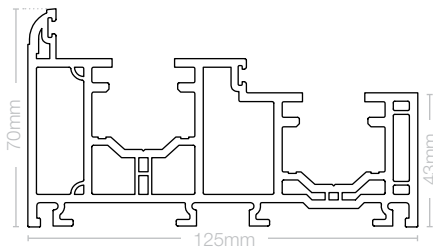

Frame  
**VSW001**

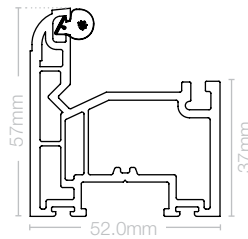

Slim top sash  
**VSW002**

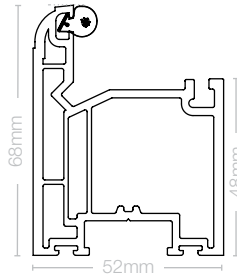

Medium bottom sash  
**VSW003**

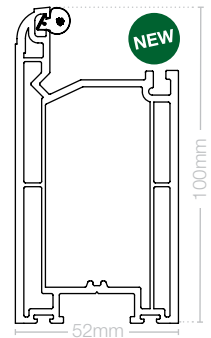

**charisma classic**  
Deep bottom rail  
**VSW004**

### ANCILLARIES

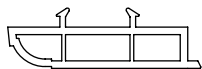

Ovolo frame stop  
**VSW107**

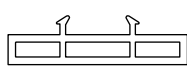

Frame stop  
**VSW102**

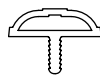

Coupler cap  
**VSW114**

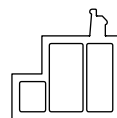

Adaptor frame extension  
**VSW103**

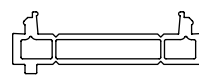

10mm add-on  
**VSW104**



Interlock  
**VSW101**

### ALUMINIUM COMPONENTS

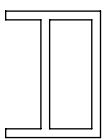

Frame reinforcement  
**VSW501A**

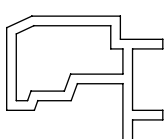

Slim top sash reinforcement  
**VSW502A**



Medium bottom sash reinforcement  
**VSW503A**

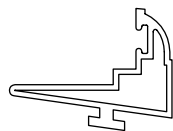

Security bar  
(white powder coating)  
**VSW504A**

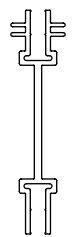

Coupler  
**VSW505A**

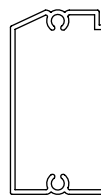

**charisma classic**  
Deep bottom rail reinforcement  
**VSW514A**

### MISC

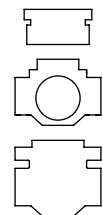

Window enhancement pack  
**VSW404**

### BEADS & BRUSH SEAL



**NEW**  
Infill trim  
**VSW109**  
(white only)



Brush seal (frame)  
**VSW401G**



Brush seal (sash)  
**VSW402G**



Overhead vent insert  
**VSW105**

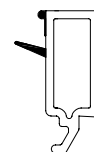

Square bead  
**VSW301**

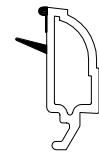

Ovolo bead  
**VSW302**

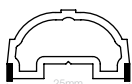

External Georgian bar  
**VSW303**

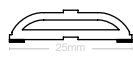

Internal Georgian bar  
**VSW304**



19mm Georgian bar tape  
**EWS419**



22mm Georgian bar tape  
**EWS420**

**CILLS**

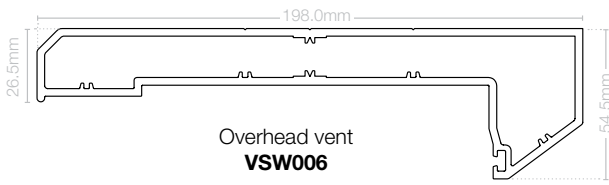

Overhead vent  
**VSW006**

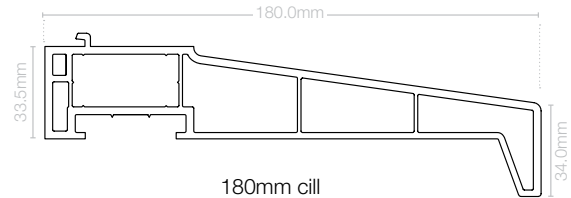

180mm cill  
**VSW008**

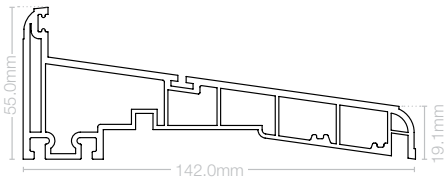

Ovolo cill adaptor  
**VSW009**

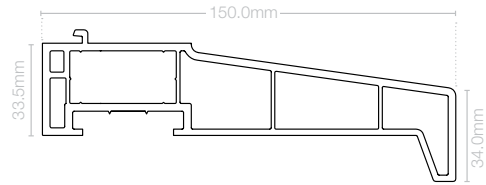

150mm cill  
**VSW007**

**STEEL COMPONENTS**

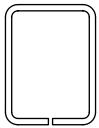

Mainframe reinforcement  
**VSW601S**

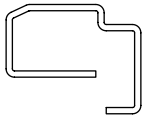

Slim top sash reinforcement  
**VSW602S**

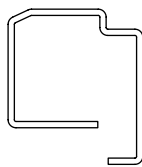

Medium bottom sash reinforcement  
**VSW603S**



Mainframe reinforcement  
**VSW604S**

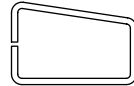

Cill adaptor reinforcement  
**VSW605S**

**PVC-U THERMAL INSERTS**

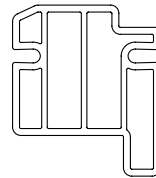

**VSW803P**

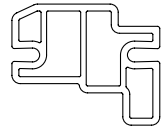

**VSW802P**

**ACCESSORIES**



Cill adaptor end cap  
**VSW205**

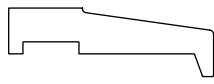

150mm cill end cap  
**VSW207**

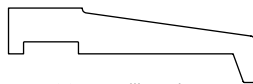

180mm cill end cap  
**VSW208**



Glass packer  
**VSW203**



Spring balance fixing kit  
**VSW607S**



Fixing cleat  
**VSW608S**

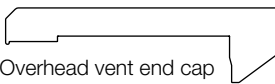

Overhead vent end cap  
**VSW206**



Security bar end cap  
**VSW204**

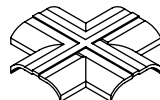

Slimline Georgian bar moulding  
**VSW306**

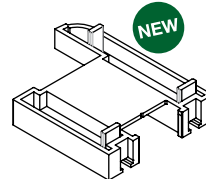

**charisma classic**  
Deep bottom rail end moulding  
**VSW214**

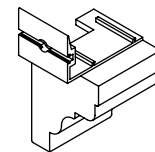

Decorative horn  
**VSW201**

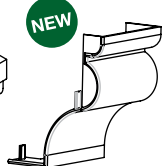

**charisma classic**  
Through horn  
**VSW210**

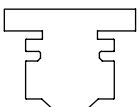

Frame stop cap  
**VSW202**

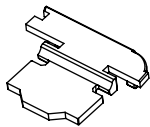

Ovolo crash stop end cap  
**VSW209**



Georgian bar fixing kit  
**VSW606S**



Georgian bar end cap  
**VSW305**



**CAVALOK**

CAVITY CLOSER SYSTEMS

## Indispensable frame-forming cavity closers – made from 100% recycled PVC-U

Cavity closers are a critical building component, now widely used in all commercial and residential new-build projects. They are the simplest and most effective way to seal cavities around wall openings and provide a rigid template for bricklaying and window or door installation.

The Cavalok cavity closer range from Eurocell is BBA accredited and made from 100% post-consumer recycled PVC-U. Pre-insulated Cavalok cavity closers are the most widely used frame-forming closures – helping to save time, cost and energy on development projects.

### **Meeting standards**

The Cavalok cavity closer product range includes the one-hour fire-rated FlameBlok closer, and the BigBlok closer, which is uniquely designed to fit cavities up to 300mm wide, which are increasingly specified for low and zero-carbon buildings. You can also choose the Structural Closer for specialist applications associated with higher specification and Passive House Design requirements.

Cavalok cavity closers have been used to build new houses that achieve Level 6 in the Code for Sustainable Homes.



## Why use cavity closers?

### ▶ **Effective**

PVC-U cavity closers are the simplest, most effective way to close off cavities around wall openings and provide a rigid window or door frame acceptor.

### ▶ **Easy-to-install**

The simple modular system requires minimal tools and gives you consistent performance every time.

### ▶ **Thermal efficiency**

Cavalok cavity closers also offer the option of a pre-installed structural foam insulation core, which improves thermal efficiency for part L Building Regulations compliance, enables loading of heavy A++ rated windows directly over the cavity and saves time on site because no additional insulation needs to be fitted.

### ▶ **Prevent cold-bridging, condensation and mould:**

Using rigid PVC-U cavity closers gives a close fit around all building apertures to prevent draughts. It creates an effective damp-proof barrier and prevents cold-bridging, condensation and mould growth.

### ▶ **Compatibility**

The Cavalok cavity closer is a universal system designed to accept most window systems. Windows can be fitted from either inside or outside the building, helping you to comply with HSE guidelines on working at height.

# CAVITY CLOSER SYSTEMS

## PRODUCT RANGE



### Universal cavity closer

- ▶ For cavity sizes from 50mm-100mm
- ▶ Ideal for new-build projects
- ▶ Optimal fully insulated thermal efficient design

Specifying the Cavalok universal cavity closer takes all the hassle and uncertainty out of creating window and door openings in new buildings. You can quickly create precise, rigid, robust openings that comply fully with Building Regulations – saving you time and money in the construction process.

- ▶ Easy to install using standard plastic ties to fix into coursework as you build. Metal ties also available for use with the thin joint blockwork systems
- ▶ Compatible with masonry, steel or timber-framed buildings
- ▶ Fully approved by the BBA and NHBC
- ▶ Intelligent design compatible with all window systems

#### The universal cavity closer features:

- ▶ Universal closures
- ▶ Brace bars
- ▶ Moulded corners
- ▶ Locking clips
- ▶ Wall ties
- ▶ Window board receptors
- ▶ Overhead ventilation
- ▶ 100mm structural closer and door set set are stock items. Other sizes made to order

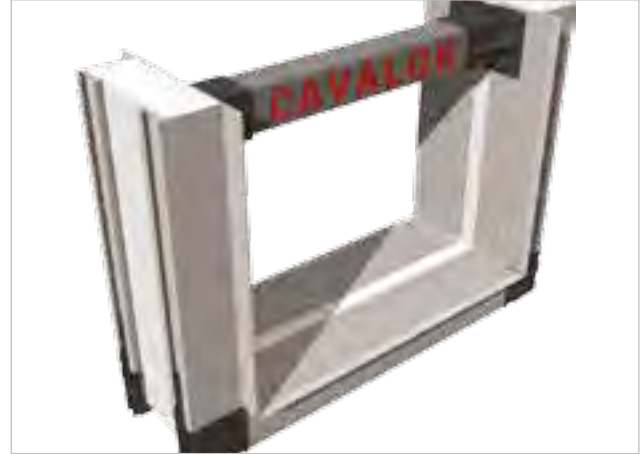

### BigBlok cavity closer

- ▶ For cavity sizes from 125mm-300mm
- ▶ Ideal for energy-efficient new-build projects

To meet demand for increasingly energy-efficient homes, we offer the BigBlok super-insulating cavity closer. BigBlok has been specifically designed to fit into the large cavities that are increasingly being specified for energy efficient new-build properties to meet stringent thermal efficiency regulations.

BigBlok is a simple slot-together universal system, which is quick and cost-effective to install, making it an essential component for low U-value construction.

- ▶ Manufactured from post-consumer recycled PVC-U – for a sustainable solution.
- ▶ Closes openings with continuous CFC/HCFC-free insulation – reducing U-values and preventing thermal bridging.
- ▶ Quick and easy to fabricate and fit, with straight cuts and slot-together fitting.
- ▶ Compatible with PVC-U, timber, steel and composite doors and windows.
- ▶ Robust construction to withstand demanding site conditions.
- ▶ Extensive range of fitting options to suit every building project.

Available in a range of cavity sizes to meet latest building regulations: 125mm, 140mm, 150mm, 170mm, 200mm, 250mm, 300mm





### Structural cavity closer

- ▶ For cavities up to 300mm
- ▶ Designed to accept direct loads

Structural cavity closers have been developed to accept direct loads on wider cavities up to 300mm. As such, they meet Passive House and Code for Sustainable Homes requirements, and facilitate 'fabrication first' design processes.

- ▶ No need for long window straps, with excellent screw retention for direct window fixing.
- ▶ New super-insulating structural foam technology enables loading of heavy A++ rated windows directly over the cavity.
- ▶ Developed for 'fabrication first' design principles.
- ▶ Cill support brackets reinforced with steel for inner and out leaf support.
- ▶ Forms a template to facilitate square and accurate opening for brick laying.

### Structural foam

- ▶ Available as a separate product
- ▶ Bespoke cold bridging solution



### FlameBlok cavity closer

- ▶ For cavity sizes from 50mm-150mm
- ▶ Ideal for high-risk timber-framed or commercial developments

The FlameBlok cavity closer is the first fully tested fire-rated cavity closer for cavities greater than 100mm. It is the only fire-rated closer made from post-consumer recycled PVC-U. Wall cavities are a hidden danger area for fires, so fire-rated cavity barriers are essential to help prevent fires from spreading.

By combining a cavity closer and fire barrier in a single product, FlameBlok saves labour on site and creates a continuous ring of fire protection around openings in cavity walls.

- ▶ High-performance passive fire protection for up to 90 minutes in masonry walls.
- ▶ Manufactured from post-consumer recycled PVC-U.
- ▶ Unique foil-wrapped high-density fire-resistant mineral wool makes product easier to handle and reduces spread of flame.
- ▶ Widest product range available in a fire-rated closer – for cavities 50-150mm wide.
- ▶ Quick and easy to fabricate and fit – no additional fire socks required.
- ▶ Fully approved by BBA and NHBC and compliant with latest Building Regulations.

# CAVITY CLOSER SYSTEMS

## PRODUCT RANGE CONTINUED



### Trade cavity closer

- ▶ For cavity sizes from 50-100mm
- ▶ Ideal for refurbishment projects

The simple, versatile Trade cavity closer is designed for retrofitting on refurbishment projects. Just like other Cavalok cavity wall closers, it integrates high-performance insulating foam with post-consumer recycled PVC-U to provide outstanding thermal performance at door and window openings on existing buildings.

Supplied in any length for trimming on site, the simple design of the Trade closer makes it compatible with all types and age of cavity wall. It simply slots into place between walls around building openings.

- ▶ Manufactured from post-consumer recycled PVC-U.
- ▶ Insulates and seals cavities around windows and doors in existing walls.
- ▶ Quick and easy retrofit on any building.
- ▶ Robust construction to withstand demanding site conditions.
- ▶ Adapts to cavities between 50mm and 100mm.



### HeadVent

Buildings require a constant source of fresh air all year round to keep them well ventilated and comfortable. The Cavalok HeadVent is the simple, unobtrusive way to deliver excellent ventilation to your buildings, without the need for through-frame ventilation.

Cavalok HeadVent provides an attractive slimline over-frame ventilation profile that maximises air flow and minimises fabrication. It requires minimal fitting time. By venting over the window frame, it also makes it easier to meet the requirements of Part F of the Building Regulations.

- ▶ Slimline, scotia-moulded design provides sleek, unobtrusive appearance.
- ▶ Maximises air flow and meets Part F regulations.
- ▶ Simple and fast installation – saving time and money.
- ▶ Compatible with all PVC-U window systems up to 75mm wide.
- ▶ Range of complementary vent and grill accessories available to optimise appearance, compatible with most proprietary vent systems
- ▶ Designed to combine easily with Cavalok cavity closer products.



### Structural Door Set

- ▶ Cavllok 100mm cavity closer with structural foam inserts
- ▶ Ability to direct fix through outer door frame into the cavity closer, removing the reliance on strap fixings and removing any movement that may occur once the door has been installed
- ▶ Thermally efficient, acts as dpc
- ▶ To be used on entrance doors with or without fanlight & french, patio doors & bi-fold doors



### New Cavalok Brace System

The Cavalok brace system has been designed to increase the support and rigidity of larger cavity closer frames during transportation and installation.

This recycled ABS moulding will come as a much needed accessory to fabricators as we are starting to see a rise in larger cavity widths with architects being more courageous with their design and sizes of the windows and doors. Can also be used as a bracing/support system for flag window designs.

With the use of the new corner brace it will allow fabricators to use one length of bracing bar rather than two.

Screw holes designed within the moulding to allow for a quick and easy direct fix to the cavity closer frame.



# CAVITY CLOSER SYSTEMS

INSTALLATION

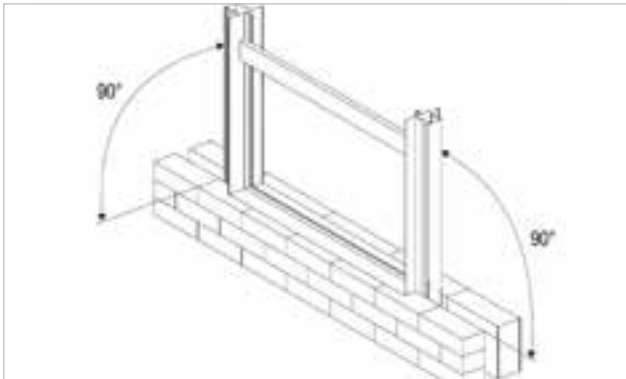

**1.** Check that the closer is level and square.

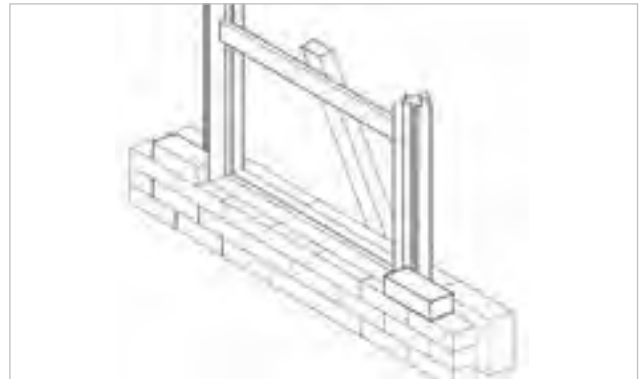

**2.** Prop the former to ensure it remains plumb, and build up the coursework around the former by one course.

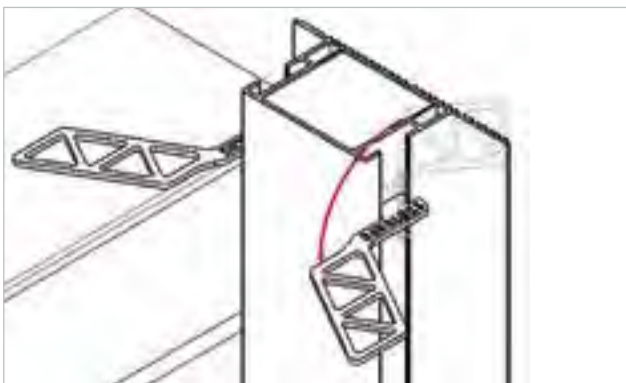

**3.** Insert brick ties into the former, rotate by 90° and bed into mortar, on both inner and outer courses.

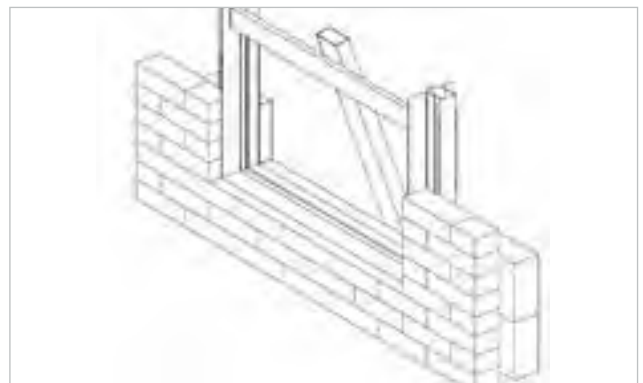

**4.** Continue to build up the coursework around the frame in the normal manner, ensuring that the frame remains plumb. Brick ties should be inserted every third outer course, and every other inner course (a minimum of three per vertical).

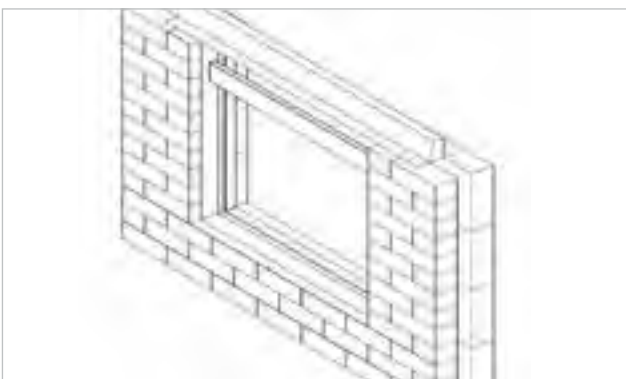

**5.** Build the inner and outer courses up to the lintel height. The lintel should be set 5mm over the former. Locate the lintel in position and bed into mortar. Allow mortar to set before removing the props and brace.

# CAVITY CLOSER SYSTEMS

## PRODUCT COMPONENTS

### CAVITY CLOSER FRAME COMPONENTS



**BBTIE**  
Brick tie



**CAVBRBOX**  
Brace bar



**BOOT14**  
Brace boot

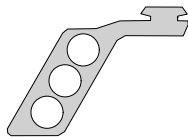

**TJBIE**  
Thin joint brick tie



**FLAGLOK100**  
Flag cleat



**CBPCORBRA**  
Corner brace

### FLAMEBLOK CLOSER SYSTEM

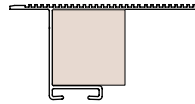

**FLB050HOR**  
50mm FlameBlok

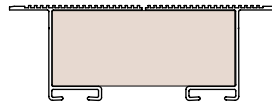

**FLB125HOR**  
125mm FlameBlok

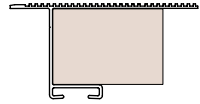

**FLB075HOR**  
75mm FlameBlok

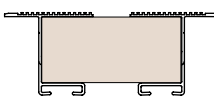

**FLB100HOR**  
100mm FlameBlok

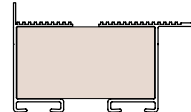

**FLB100CHK**  
100mm FlameBlok



**FLB100HOR**  
FlameBlok closer system

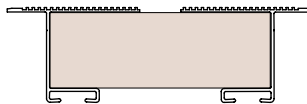

**FLB150HOR**  
150mm FlameBlok



**BBMOU**  
BigBlok corner



**FLBFIL**  
FlameBlok corner fillet

### HEADVENT SYSTEM



**CAVHENT**  
Head vent

### TRADE CLOSER SYSTEM

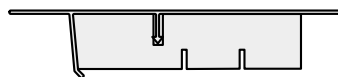

**TRD100HOR**  
50-100mm Retrofit closer

### ANCILLARIES



**STF70U2E**  
Strap fixing



**IFB**  
Internal fit endstop



**CAWBR**  
Window board receptor

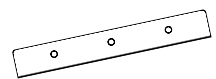

**SSF**  
Structural angle bracket



**RTUBMOD5**  
Reinforcement bar



**LOKSCLP**  
Locking clip



**LOKPOLAD**  
Foam insert

**BIGBLOK CLOSER SYSTEM**

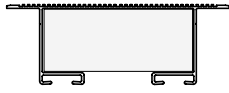

**BBS125HOR**  
125mm closer

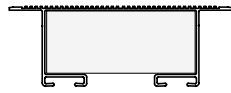

**BBS140HOR**  
140mm closer

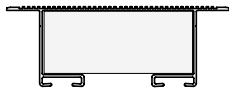

**BBS150HOR**  
150mm closer

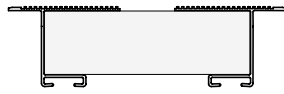

**BBS170HOR**  
170mm closer



**BBS200HOR**  
200mm closer



**BBS250HOR**  
250mm closer



**BBS300HOR**  
300mm closer

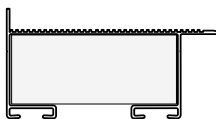

**BBS125CHK**  
125mm check reveal closer

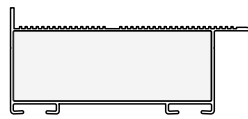

**BBS150CHK**  
150mm check reveal closer

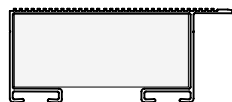

**BBS125SLR**  
125mm short leg removed



**BBMOU**  
BigBlok corner



**BBSFIL**  
BigBlok corner file

**UNIVERSAL CLOSER SYSTEM**

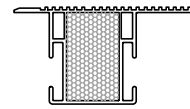

**I50HORLOK**  
50mm closer

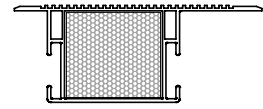

**I75HORJEL**  
75mm closer

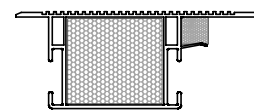

**I90HORCUC**  
90mm closer

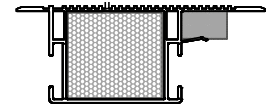

**I100HORCUC**  
OLD 100mm closer

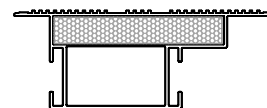

**I100HORCBX**  
100mm closer

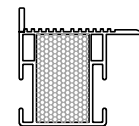

**I50CHKLOK**  
50mm check reveal

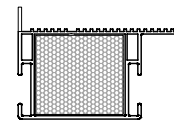

**I75CHKLOK**  
75mm check reveal

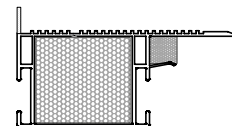

**I90CHKCUC**  
90mm check reveal

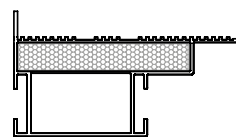

**I100CHKCBX**  
100mm check reveal

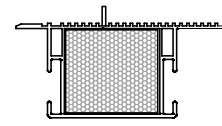

**I75EXTLOK**  
75mm external fit

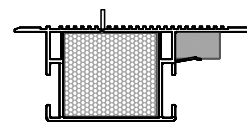

**I100EXTCUC**  
100mm external fit



**FH75**  
75mm frame hanger

**FH50**  
50mm frame hanger



**75MOU13**  
75,90,100mm corner



**50MOU**  
50mm corner



**aspect®**

BI-FOLD DOOR SYSTEM

The first bi-fold door system in the UK to achieve BBA certification and Secured by Design accreditation

### **Architectural door style in demand**

As homeowners and housebuilders seek to improve their homes and inject that elusive 'wow' factor, the stunning bi-fold style of door has become an increasingly popular choice. Panoramic doors enable large glazed 'walls' to be created, flooding interiors with natural light and bringing the outside into the home. The concertina-style folding and sliding design enables the entire doorway to be opened up, seamlessly integrating indoor and outdoor spaces.

### **Aspect makes aspirations a reality**

To help fabricators and installers meet this growing demand, Eurocell developed Aspect – a high-performance, secure and visually stunning PVC-U bi-fold door system. Aspect offers all the aesthetic and functional benefits of timber and aluminium alternatives, but at a more affordable price. It incorporates a host of intelligently designed and precision-engineered bespoke components that enable accurate, consistent, straightforward fabrication and installation.





## **Engineered for fast, efficient, consistent fabrication**

Aspect panoramic doors have been purpose-designed by our technical specialists to include a host of features that enable quick and simple fabrication and fitting, without compromising on the quality or appearance of these stunning panoramic doors. These features include:

### **Minimal welding, cutting and trimming**

The Aspect profile system requires minimal welding, cutting and trimming – giving a better quality, more consistent finish to every panoramic door.

### **Compatible components for simpler stockholding**

Doors feature a standard Eurocell Eurologik gasket and are compatible with our patented Eurologik chamfered and ovolo beads – so if you're already fabricating Eurologik windows and doors, there's no need for additional stockholding.

## **Integral gaskets save time and money**

The door profile and outer frame glazing gaskets are co-extruded, so you won't have to buy gaskets separately and fit them yourself – saving you time and money.

## **Fewer components for faster fabrication**

Aspect has been designed with no need for a dummy mullion, reducing the number of components you need to fit – for faster, more efficient fabrication.

## **Single roller-track colour for all door options**

A neutral-coloured anodised aluminium track is used to complement all door colour options, so you won't have to stock a different track for every door colour.



**aspect®**

## BI-FOLD DOOR SYSTEM

### FEATURES AND BENEFITS

#### Aesthetics

- ▶ Door openings up to six metres wide, with up to seven door panels.
- ▶ Unique roller assembly enables doors to be configured to meet customer preferences, including the popular 4/2/2 configuration as well as simple 2/2/0 arrangements to replace existing patio doors.
- ▶ Patented trim conceals unsightly black gaskets between door leaves, creating a clean, attractive finish.
- ▶ Doors require no dummy mullion – a patented feature – creating an uncluttered door finish with equal sightlines.
- ▶ Doors can be fitted with midrails and letter plates for front entrances, and can incorporate opening sashes within the door.
- ▶ Attractive, unobtrusive D-handle fits flat to the door frame, enabling opened door leaves to sit neatly side by side – maximising the size of the door opening.
- ▶ Compatible with Eurocell Eurologik window and conservatory systems.

#### Functionality

- ▶ Enclosed four-rail aluminium roller track provides smooth opening, easy-glide door operation.
- ▶ Unique Eurocell D-handle engages top and bottom shoot bolts, and is specially engineered to prevent bolts being engaged when the doors are open.
- ▶ In-built rollers minimise threshold height, as standard.
- ▶ Flush-fitting internal room dividing threshold available.
- ▶ Part-M threshold double ramp available.
- ▶ Unobtrusive, finger-operated shoot bolt for traffic door leaves – designed for easy operation to engage both top and bottom shoot bolts.
- ▶ Angled threshold drip trim contoured to expel water and maintain excellent weather tightness (can be reversed to act as a head drip trim).
- ▶ Magnetic door stops keep doors neatly folded back.

#### Security

- ▶ Top rollers feature integral anti-jemmy pins, so doors cannot be removed by force from the outside.
- ▶ All sashes are steel reinforced for superior strength and rigidity.
- ▶ BS 6375 and PAS 24 accredited.

## ACCREDITATIONS

▶ **BBA**

Aspect is the first bi-fold door of any material in the UK to gain BBA certification.

▶ **Secured By Design**

Aspect is the only bi-fold door on the market that meets both BBA and strict Secured by Design guidelines

▶ **PAS 24**

For enhanced security – allows fabricators to achieve Secured By Design status.

▶ **BS 6375**

Aspect doors exceed the minimum requirements set out for the weather test.

## DOOR PROFILE COLOUR OPTIONS

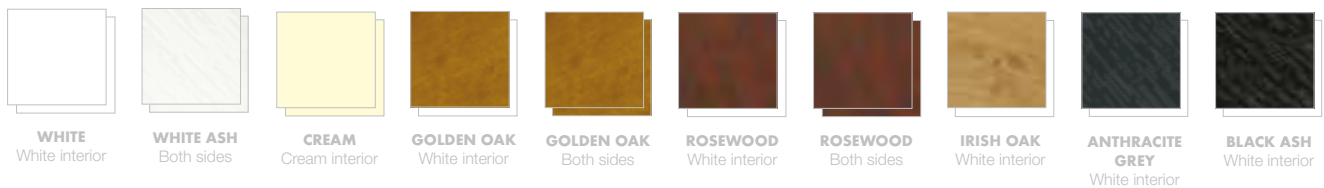

Additional colours and specifications can be made to order on extended lead times.

## HARDWARE COLOUR OPTIONS

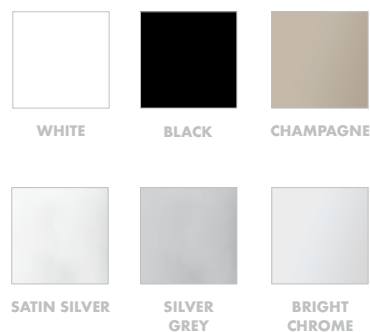



aspect®

BI-FOLD DOOR SYSTEM

# KEY FEATURES



**Trim to conceal gaskets**



**No dummy mullion needed**



**Unique D-handle**



**Bespoke British designed and manufactured hardware**



**Part M threshold available**



**In-built rollers**



**Finger-operated shootbolts**



**Combined wool-pile and gasket slots**

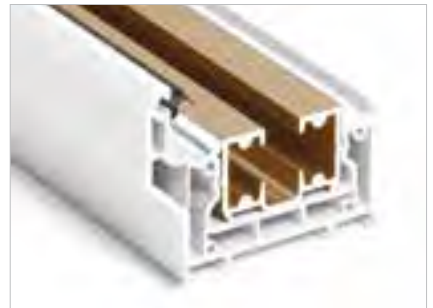

**Slim-stepped outer frame with anodised aluminium track**



**Co-extruded glazing gaskets**



**'Grab' hinge handle aids the opening and closing of multiple door leaves**



**Magnetic door stops for a neat fold**

# DOOR CONFIGURATIONS

## ASPECT BI-FOLD DOOR SYSTEM



**4**

Total  
number  
of leaves

**2**

Number  
of leaves  
folding left

**2**

Number  
of leaves  
folding right

All options are available with inward or outward opening doors.

Extra leaves and additional configurations can be chosen, up to the maximum width of six metres.

For spans of more than six metres, multiple doors can be butt-jointed. A project assessment by a qualified structural engineer will be required.

## MULTIPLE OPTIONS AVAILABLE

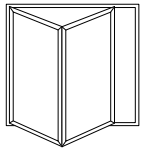

**2-2-0**  
(2-0-2 available)

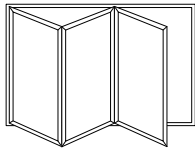

**3-3-0**  
(3-0-3 available)

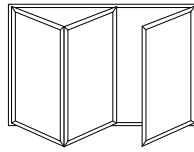

**3-2-1**  
(3-1-2 available)

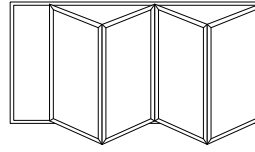

**4-0-4**  
(4-4-0 available)

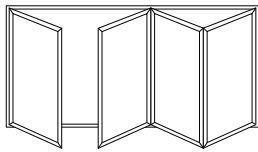

**4-1-3**  
(4-3-1 available)

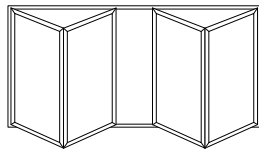

**4-2-2**

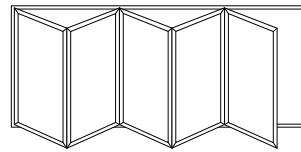

**5-5-0**  
(5-0-5 available)

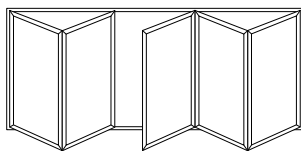

**5-2-3**  
(5-3-2 available)

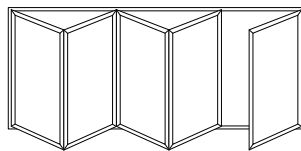

**5-4-1**  
(5-1-4 available)

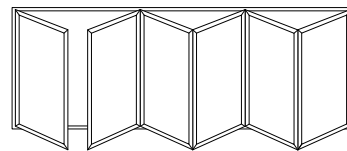

**6-1-5**  
(6-5-1 available)

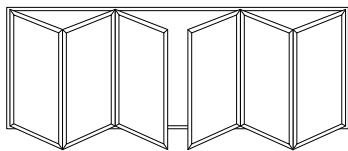

**6-3-3**

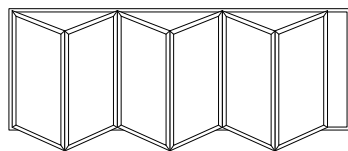

**6-6-0**  
(6-0-6 available)

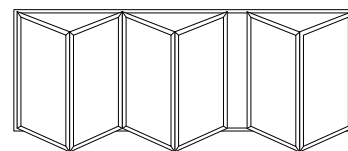

**6-4-2**  
(6-2-4 available)

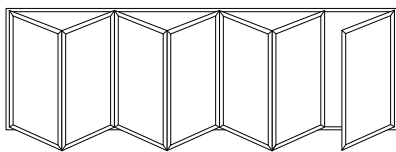

**7-6-1**  
(7-1-6 available)

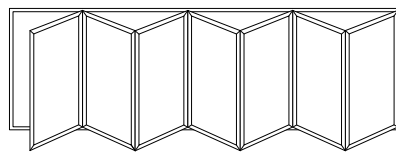

**7-0-7**  
(7-7-0 available)

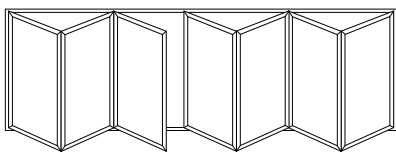

**7-3-4**  
(7-4-3 available)

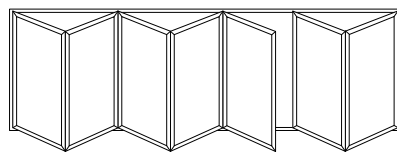

**7-5-2**  
(7-2-5 available)

# TECHNICAL INFORMATION

## ASPECT BI-FOLD DOOR SYSTEM

### THRESHOLDS

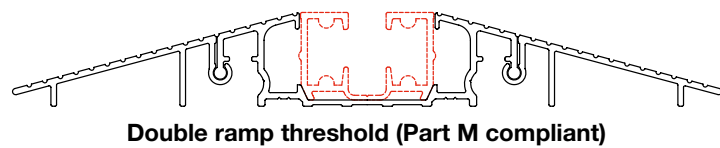
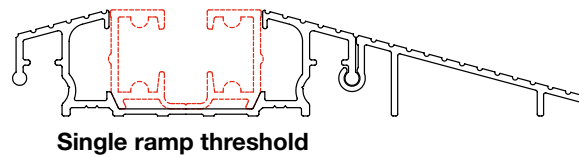
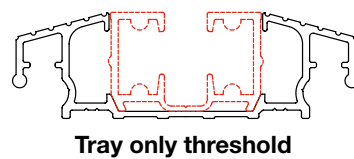
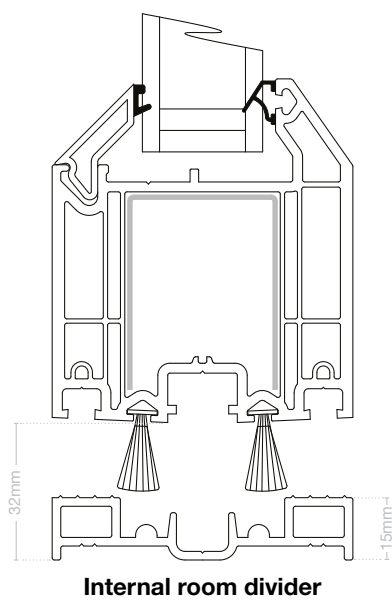



# CROSS SECTIONS

**Horizontal** (open out)

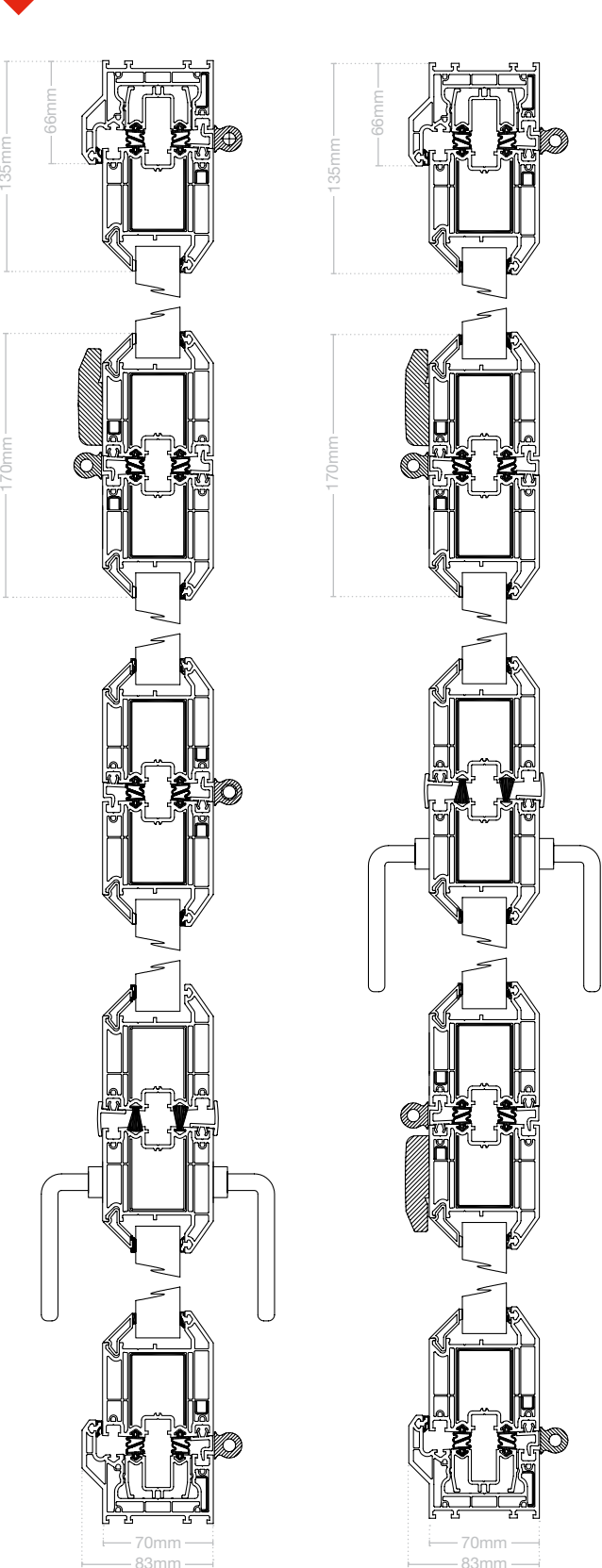

**Vertical** (open in)

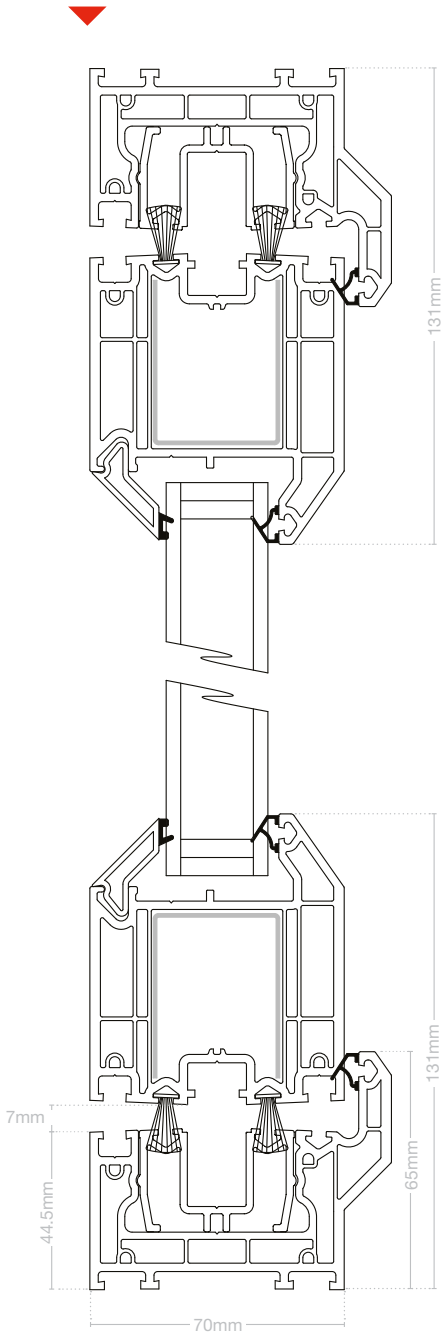

Image courtesy of Lissett Homes



euroslide®

## IN-LINE PATIO DOOR SYSTEM

### Superior security and comfort for PVC-U patio doors

In-line sliding patio doors are the cost-effective way to bring the outside in to any building and to flood the interior with natural light. Ideal for conservatories, living rooms or offices, the space-saving Euroslide patio door system has been upgraded for improved safety and strength – creating the best patio door system in its class.

#### **Built for safety and strength**

To meet ever more demanding security regulations for doors and windows, Euroslide has been re-engineered to create our strongest and most secure in-line patio door system – giving you a reliable and assured way to provide a PAS24-certified product for your customers.

#### **Tested and certified for Document Q compliance**

When Euroslide is fabricated to PAS24 standards, you will automatically meet Document Q – the newest security regulations for patio doors. Features that make a PAS24-configured Euroslide patio door such an effective barrier to intruders are:

- ▶ A heavy-duty door sash reinforcement to protect against forced entry and high winds.
- ▶ An anti-lift fixture that stops intruders lifting panes out of the door frame.
- ▶ Internal glazing – all gaskets and sealants are applied from the inside so they can't be accessed by intruders.
- ▶ An aluminium internal interlock and locking device.



## **Flexible configurations**

Euroslide patio doors give you the flexibility to create various door styles, with two, three and four-pane options available\*. You can enhance your doors with a range of high-quality door furniture in a choice of chrome, gold or white.

## **Keep the elements out**

PVC-U patio doors provide superb protection from the elements. The profile structure features separate chambers for improved drainage, strength and thermal efficiency.

## **Fast, hassle-free installation**

Integral gaskets and our patented knock-in bead system enable rapid, simple fabrication and installation, while an optional overhead vent avoids the need for routing through the door profile.

*\*PAS24 2 Pane only.*



**euroslide®**

## IN-LINE PATIO DOOR SYSTEM

### Up to 10-year guarantee

Euroslide patio door profiles are guaranteed for ten years. So you and your customers enjoy all the reassurance of a robust, well-designed, precision-made product that's built to last.

### COLOUR OPTIONS



**WHITE**  
White interior

**CREAM**  
Cream interior

**GOLDEN OAK**  
White interior

**GOLDEN OAK**  
Both sides

**IRISH OAK**  
Both sides



**ROSEWOOD**  
White interior

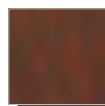

**ROSEWOOD**  
Both sides

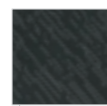

**ANTHRACITE  
GREY**  
White interior



**BLACK ASH**  
White interior

Additional colours and specifications are made to order on extended lead times

## FEATURES & BENEFITS



**Anti-lift device prevents panes being lifted by intruders**



**Full Eurogroove to accept most kinds of suitable hardware**



**Separate chambers for improved drainage, thermal efficiency and strength**



**Fully bevelled profile for a slim visual profile and clean sight lines**



**Fusion welded joints for accuracy and strength**



**Patented knock-in 45° putty line and scotia bead also available**



**Pre-gasketed sash reduces fabrication time**



**Robust steel and aluminium reinforcing sections**



**Part M compliant low-threshold for improved accessibility**

# TECHNICAL INFORMATION

## EUROSLIDE PATIO DOORS

### DOOR CONFIGURATIONS

System	Width (mm)	Height (mm)
2 pane	Max: 3000 Min: 1650	Max: 2455 Min: 1950
3 pane	Max: 4500 Min: 2480	Max: 2455 Min: 1950
4 pane	Max: 5930 Min: 3220	Max: 2455 Min: 1950

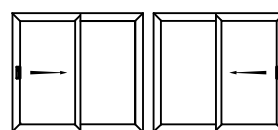

2 pane

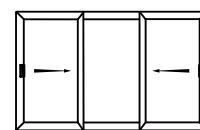

3 pane 2 sliders

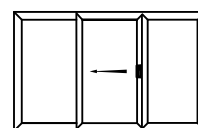

3 pane  
centre sliding

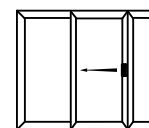

3 pane offset  
centre sliding

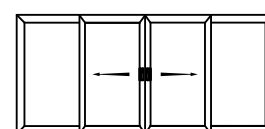

4 pane

# CROSS SECTIONS – STANDARD KIT SPECIFICATION

## Horizontal

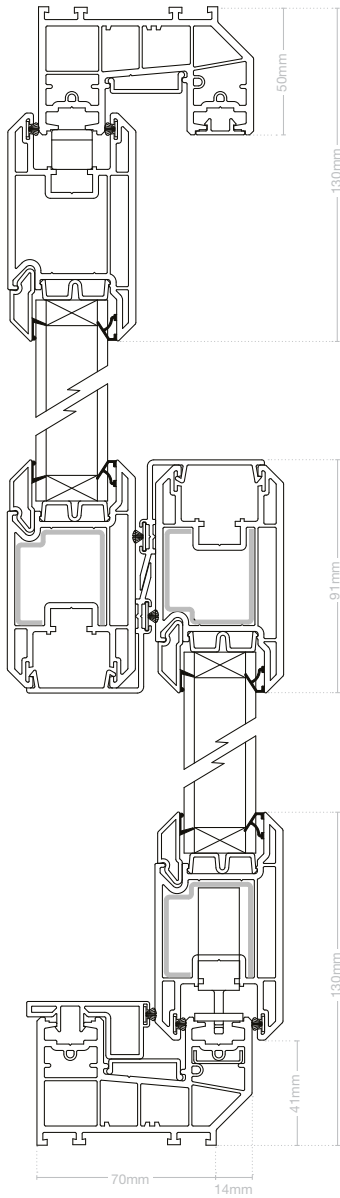
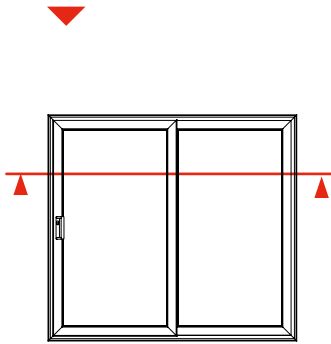

## Vertical

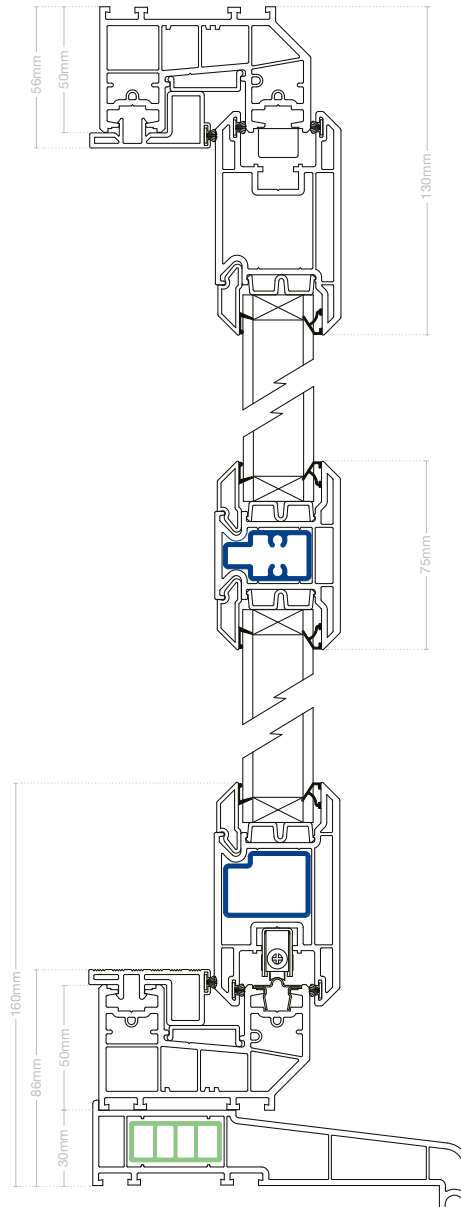
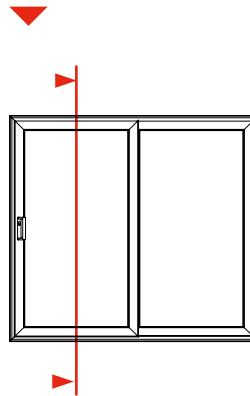

# PAS24 / LIFETIME HOMES

## SPECIFICATION

### DOOR CONFIGURATIONS PAS24

System	Width (mm)	Height (mm)
2 pane	Max: 3000 Min: 1650	Max: 2400 Min: 1950

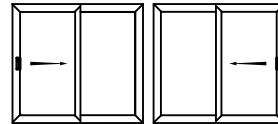

### PAS24 PATIO KITS

Part Number	Description	Pack Qty
EWS915KW1.93	Patio PAS24 Interlock Kit 1930mm White	1 kit
EWS915KW2.13	Patio PAS24 Interlock Kit 2130mm White	1 kit
EWS715KW	Patio PAS24 Handle Kit White	1 kit
EWS716K	Patio PAS24 Lock Kit	1 kit

### LOW THRESHOLD KITS

Part Number	Description	Pack Qty
EWS955AKS	Patio Low Threshold Kit 1650-2100 Gold	1 kit
EWS956AKS	Patio Low Threshold Kit 2101-3000 Silver	1 kit
EWS957AKS	PAT Low Threshold Wheelchair Ramp 2101-3000 Silver	1 Length

### Lifetime Homes Kit

Lifetime Homes stipulates 16 Design Criteria that can be universally applied to new homes at minimal cost. Each design feature adds to the comfort and convenience of the home and supports the changing needs of individuals and families at different stages of life.

The following additional kits are required to make a Document Q / Lifetime Homes compliant patio door:

- ▶ 1 off Low Threshold Kit
- ▶ 1 off Patio PAS24 Lock Kit
- ▶ 1 off Patio PAS24 Handle Kit (White Chrome or Gold)
- ▶ 1 off Patio PAS24 Interlock Kit



Patio Interlock Espagnolette Handle



PAS24 Pull Handle

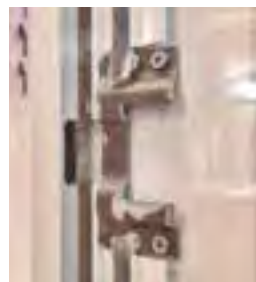

Security Plate (Sliding Sash)



Security Plate (Fixed Sash)



# CROSS SECTIONS – PAS24 KIT SPECIFICATION

## Horizontal

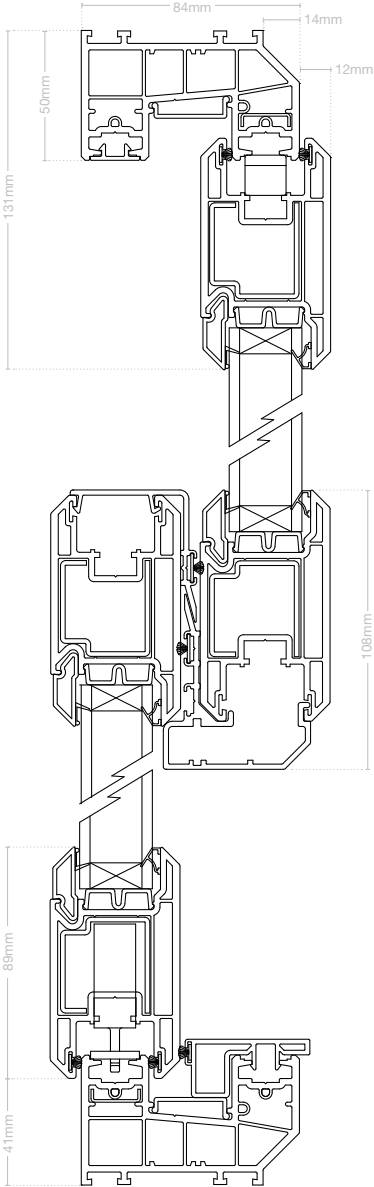
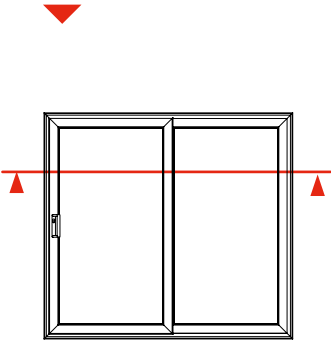

## Vertical

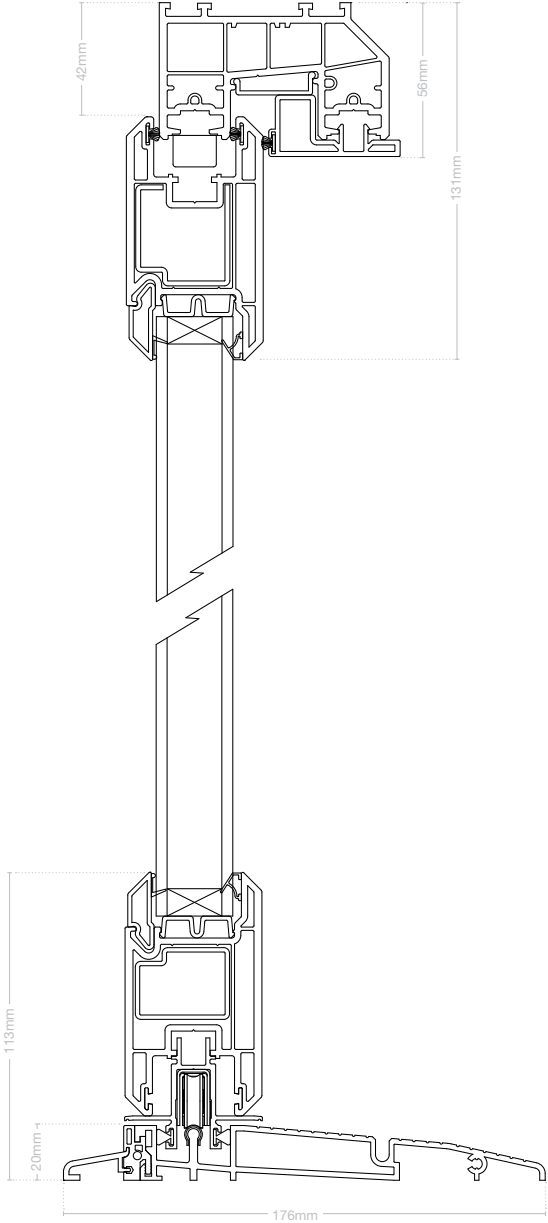
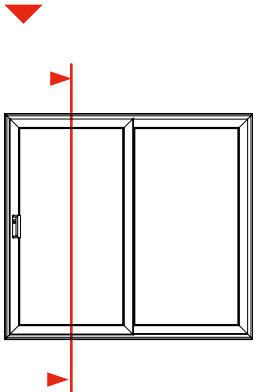

# TECHNICAL INFORMATION

## EUROSLIDE SYSTEM COMPONENTS

### MAIN PROFILES

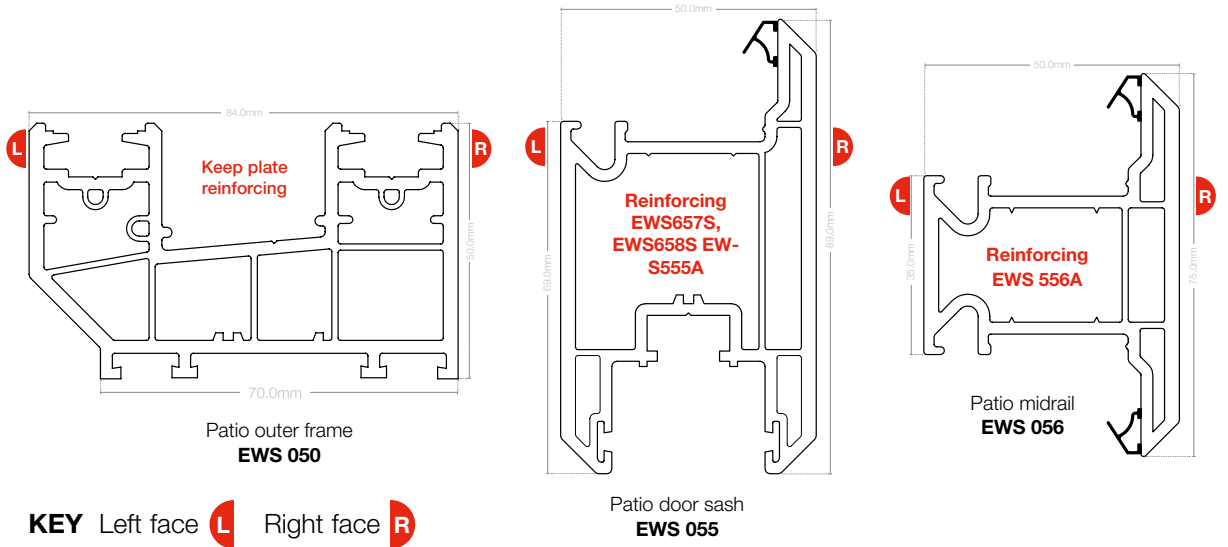

### CILLS

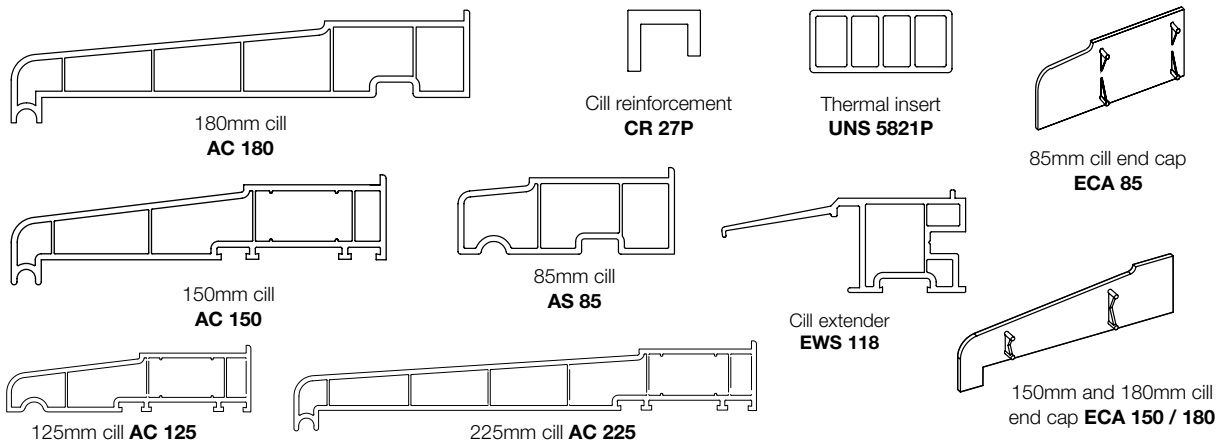

### MOULDINGS

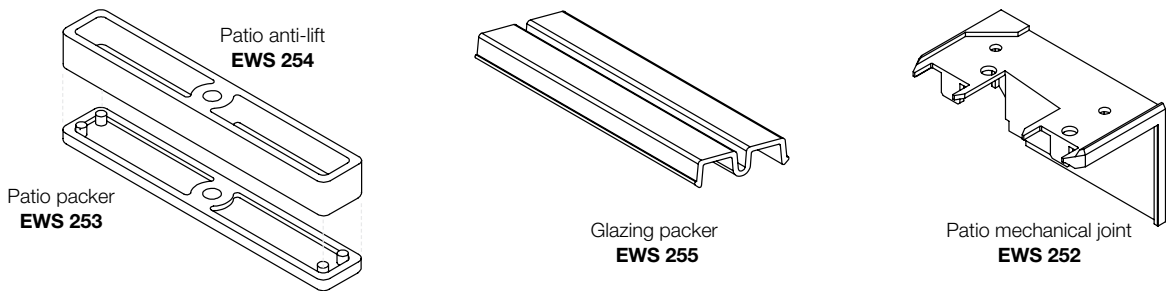

**ANCILLARIES, BEADS & WOOL**

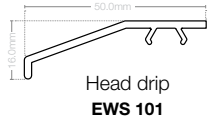

Head drip  
**EWS 101**

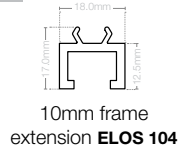

10mm frame  
extension **ELOS 104**

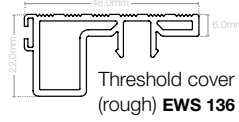

Threshold cover  
(rough) **EWS 136**

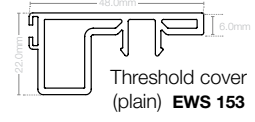

Threshold cover  
(plain) **EWS 153**

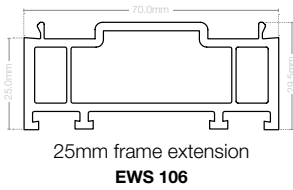

25mm frame extension  
**EWS 106**

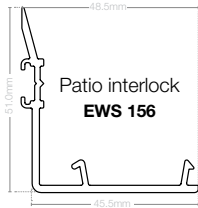

Patio interlock  
**EWS 156**

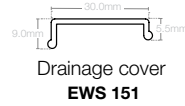

Drainage cover  
**EWS 151**

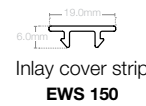

Inlay cover strip  
**EWS 150**



Interlock seal  
**EWS 452G**

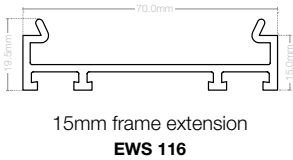

15mm frame extension  
**EWS 116**

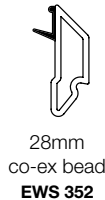

28mm  
co-ex bead  
**EWS 352**

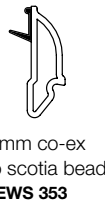

28mm co-ex  
ovolo scotia bead  
**EWS 353**



5mm wool pile  
**EWS 450G**  
threshold seal - grey



6.5mm wool pile  
**EWS 451G**  
door sash seal - black



Mainframe drainage dam  
**EWS 453 GWP**  
for internal sliding patios only



Mainframe drainage dam  
**EWS 431G**  
for 3-4 pane patios only

**STEEL COMPONENTS**

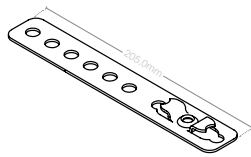

70mm fixing cleat  
**EWS 612S**

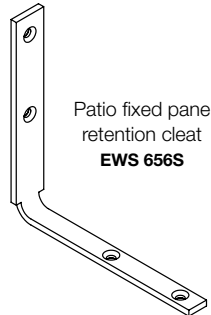

Patio fixed pane  
retention cleat  
**EWS 656S**



Stainless steel track  
**EWS 653S**



Keep plate  
reinforcement  
**EWS 652S**

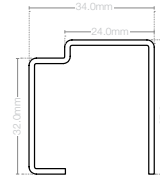

Reinforcement  
For door sash  
**EWS 657S**

Reinforcing for door  
sash (pre-punched)  
**EWS 658S**

**ALUMINIUM COMPONENTS**

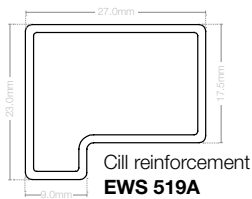

Cill reinforcement  
**EWS 519A**

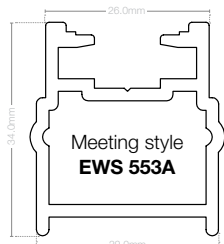

Meeting style  
**EWS 553A**



Door sash  
wheel support  
**EWS 555A**

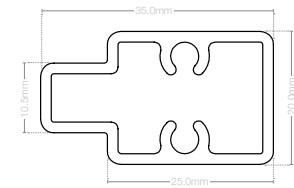

Mechanical joint / reinforcement  
for midrail **EWS 556A**



## the dales collection®

### COMPOSITE DOORS

Advanced composite doors offering unrivalled aesthetics, security and energy efficiency for every residential property

The Dales Collection of composite doors from Eurocell gives you the most advanced engineering, design and technology for front and back entrance doors. With a choice of 12 styles in 15 colours and attractive glazing options, the Dales Collection has a door for every style of home – whether contemporary chic, traditional Edwardian or quaint cottage.

#### **Superior security**

Dales Collection doors feature the latest five-point locking technology for maximum security. PVC-U edge-banding to both lock-side and hinge-side of the door helps to protect against damage. For further reassurance, all our composite doors and locks have been through rigorous tests which have earned them the approval of the Association of Chief Police Officers' Secured by Design scheme and the Police Preferred Specification PAS24.

#### **Low-maintenance design**

The glass reinforced plastic (GRP) door leaf means there is no risk of splits or cracks. This outer skin is easy to wipe clean and is less prone to scratching and denting than steel-faced doors.



### **Superior thermal efficiency**

With a GRP outer skin around a panel insulated with rigid foam, our composite doors retain up to six times the heat of a timber door – keeping energy bills down. Plus, PVC-U Thermal Inserts in the frame and PVC-U edge-banding on the door slab maximise energy efficiency.

### **Outstanding all-weather performance**

A high-quality triple-seal frame system means that composite doors give outstanding performance for many years. Two brush seals and a gasket seal mean that drafts and rain are kept out, even in the fiercest weather conditions.

### **Easy installation**

Composite doors are designed for simple, rapid, yet high-quality installation. They incorporate fitter-friendly three-way adjustable hinges and a wide frame for deep plaster reveals.

### **Accessible for all**

Accredited low-level aluminium thresholds are available for Part M Building Regulations compliance, offering easy access for wheelchairs and pushchairs. The Eurocell composite door range is the ideal front or back door for those seeking easy access without compromise on style or performance.

### **Colour-matching**

Dales Collection doors are also available with colour-matched weather bars.\*

\* Only available for White, Green, Blue, Red and Black.



# the dales collection®

## COMPOSITE DOORS

### Energy efficiency

The Dales Collection of composite doors offers exceptional energy efficiency. Our doors achieve a Door Energy Rating (DER) of B as standard – thanks to the rigid foam insulation core and solid GRP outer layer. Composite doors retain up to six times the heat of a timber door – keeping homes warm all year round, while reducing energy bills.

Doors with an A rating for energy efficiency can also be specified – please ask for details.

### Frame reinforcement



#### PVC-U Thermal Inserts

PVC-U Thermal Inserts are the cost-effective, easy-to-handle and sustainable alternative to steel and aluminium profile reinforcements.

Made entirely from recycled PVC-U, these advanced inserts create high-performance, energy-efficient door frames to meet legislative requirements and market demand.

As well as providing the enhanced energy efficiency and recyclability required to meet Code for Sustainable Homes and BREEAM guidelines, Eurocell PVC-U Thermal Inserts provide structural strength and rigidity for metal-free door frames. Eurocell PVC-U Thermal Inserts have been tested by the BBA to BS EN6375, achieving impressive results.

## FEATURES AND BENEFITS

- ▶ 12 stunning door styles – from traditional to contemporary.
- ▶ Tough GRP outer skin with woodgrain-effect finish, available in 15 colours.
- ▶ Insulated rigid foam infill panel – for enhanced thermal efficiency and acoustic performance.
- ▶ Triple-seal frame ensures the doors remain watertight, even in the harshest weather conditions.
- ▶ Optional aluminium low-threshold available – ideal for pushchairs and wheelchair access. Part M compliant threshold also available.
- ▶ 100% recycled PVC-U Thermal Inserts in the frame provide ultimate thermal efficiency and enhanced sustainability.
- ▶ Three-way adjustable hinges for quick and easy installation.
- ▶ Advanced cylinder lock and five-point locking technology for maximum security.
- ▶ Selection of long-life door furniture in a choice of colours, with a 25-year guarantee.

## ACCREDITATIONS

- ▶ Association of Chief Police Officers' **Secured By Design**
- ▶ **PAS 24**  
Specification for general performance requirements / enhanced security performance of door assemblies.



## COLOUR OPTIONS

### STANDARD DOOR COLOUR OPTIONS:

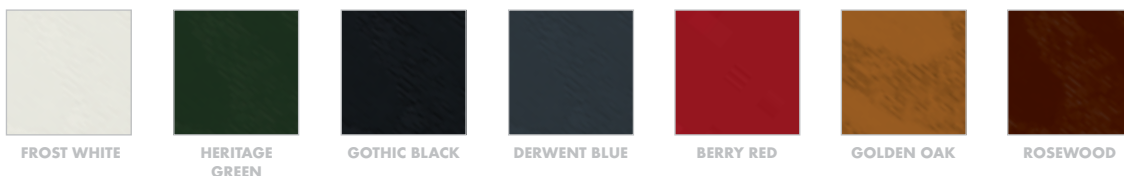

### CONTEMPORARY RANGE: (Made to order)



### HERITAGE RANGE: (Made to order)



### STANDARD FRAME COLOUR OPTIONS:

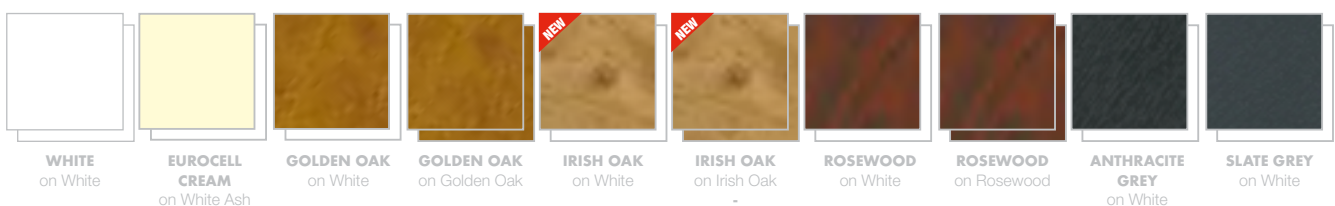

# the dales collection®

## COMPOSITE DOORS

### DOORS WITH LARGE EWS 031 OUTERFRAME

Door style	Width		Height (All low-threshold)		Height (PVC-U bottom)	
	Min	Max	Min	Max	Min	Max
Bradbourne	860	1012	1979	2089	2021	2130
Chatsworth	860	1012	1979	2089	2021	2130
Cromford	860	1012	1979	2089	2021	2130
Hathersage	860	1012	1979	2089	2021	2130
Wirksworth	835	1012	1979	2089	2021	2130
Winster	860	1012	1979	2089	2021	2130
Brassington	835	1012	1979	2089	2021	2130
Middleton	835	1012	1979	2089	2021	2130
Thorpe	835	1012	1979	2089	2021	2130
Bretton	835	1012	1979	2089	2021	2130
Chelmorton	835	1012	1964	2089	2021	2130
Litton	835	1012	1964	2089	2021	2130

If door has GRP side panel and an aluminium low-threshold, **min height = 2020**. All heights are reduced by 3mm if open out aluminium low-threshold

If door has GRP side panel and PVC-U bottom, **max height = 2121**

#### GRP SIDE PANELS

Min width	Max width	Height
410	475	To suit door

All side lights are separate.  
Sizes include outer frame and coupler

#### Top lights

Transom height from bottom of door

Aluminium low-threshold		PVC-U bottom	
Min	Max	Min	Max
1945	2054	1986	2095

Dimensions to centre of transom. Doors over 2750mm will have separate top lights

### DOORS WITH INTERMEDIATE EWS 032 OUTERFRAME

Door style	Width		Height (All low-threshold)		Height (032 full outer)		Height (031 threshold)	
	Min	Max	Min	Max	Min	Max	Min	Max
Bradbourne	830	982	1964	2074	1991	2100	2006	2115
Chatsworth	830	982	1964	2074	1991	2100	2006	2115
Cromford	830	982	1964	2074	1991	2100	2006	2115
Hathersage	830	982	1964	2074	1991	2100	2006	2115
Wirksworth	830	982	1964	2074	1991	2100	2006	2115
Winster	830	982	1964	2074	1991	2100	2006	2115
Brassington	805	982	1964	2074	1991	2100	2006	2115
Middleton	805	982	1964	2074	1991	2100	2006	2115
Thorpe	805	982	1964	2074	1991	2100	2006	2115
Bretton	805	982	1964	2074	1991	2100	2006	2115
Chelmorton	805	982	1964	2074	1991	2100	2006	2115
Litton	805	982	1964	2074	1991	2100	2006	2115

If door has GRP side panel and an aluminium low-threshold, **min height = 2005**. All heights are reduced by 3mm if open out aluminium low-threshold

If door has GRP side panel and PVC-U bottom, **max height = 2091**

032 is 15mm smaller on both faces

#### GRP SIDE PANELS

Min width	Max width	Height
410	475	To suit door

All side lights are separate.  
Sizes include outer frame and coupler

#### Top lights

Transom height from bottom of door

Aluminium low-threshold		PVC-U bottom	
Min	Max	Min	Max
1945	2054	1971	2080

Dimensions to centre of transom. Doors over 2750mm will have separate top lights



# DOOR MEASUREMENTS EXAMPLE SHOWS EWS031 OUTERFRAME

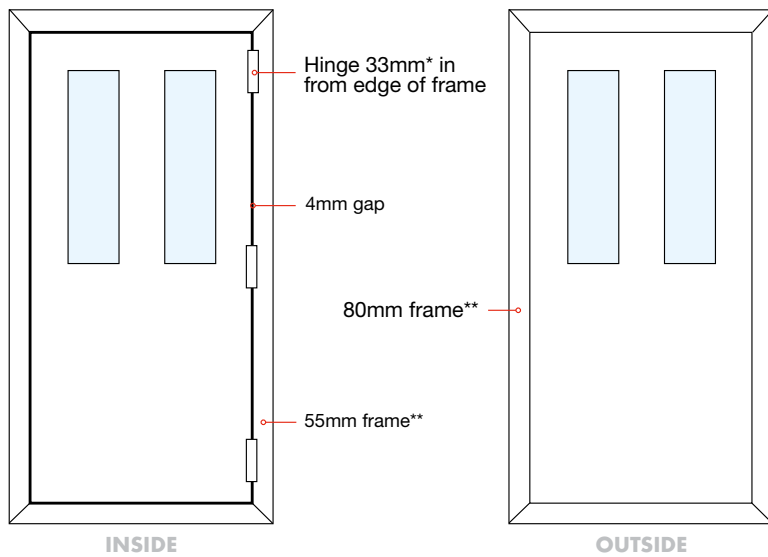

\* When using EWS032 frame, hinges are set 18mm in from the edge of the outer frame

\*\* When using EWS032 frame, sizes are 15mm smaller on both internal and external faces

### Interior door leaf

Leaf width = overall door width less 118mm

### Exterior door leaf

Opening width = overall door width less 180mm

When open at 90°, the door edge protrudes 20mm into the opening

# GLAZING SIZES ALL UNITS 4/16/4 TOUGHENED

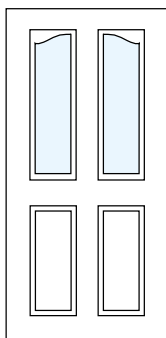

**The Bradbourne**  
Right and left eyebrow cassette  
203mm x 912mm

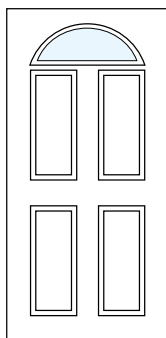

**The Brassington**  
Half moon cassette  
R279mm x 250mm

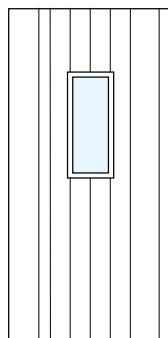

**The Bretton**  
Mid panel cassette  
202mm x 578mm

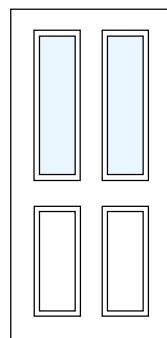

**The Chatsworth**  
Twin vertical cassette  
203mm x 912mm

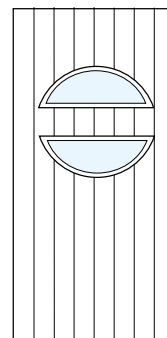

**The Chelmorton**  
2 x half moon cassettes  
R279mm x 250mm

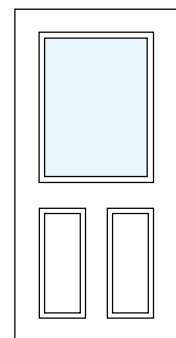

**The Cromford**  
Half glazed cassette  
558mm x 912mm

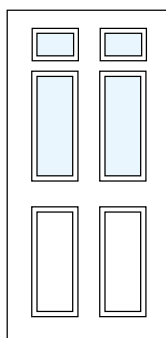

**The Hathersage**  
Twin top cassettes  
202mm x 154mm  
Mid panel cassettes  
202mm x 578mm

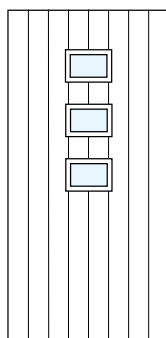

**The Litton**  
3 x twin top cassette  
202mm x 154mm

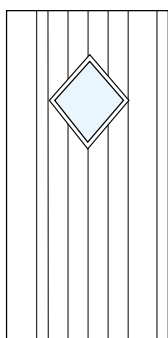

**The Middleton**  
Diamond cassette  
364mm x 345mm

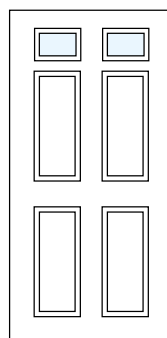

**The Thorpe**  
Twin top cassettes  
202mm x 154mm

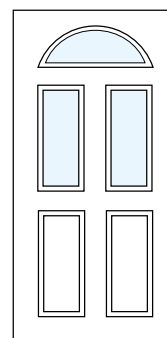

**The Winstor**  
Half moon cassettes  
R279mm x 250mm  
Mid panel cassettes  
202mm x 578mm

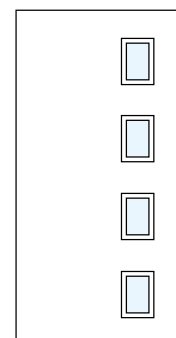

**The Wirksworth**  
4 x twin top cassette  
154mm x 202mm

# the dales collection®

## COMPOSITE DOOR FRAME COMPONENTS

### MAIN PROFILES

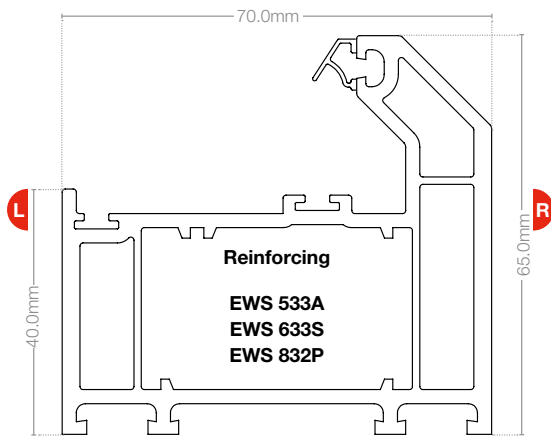

Intermediate composite door frame  
**EWS 032**

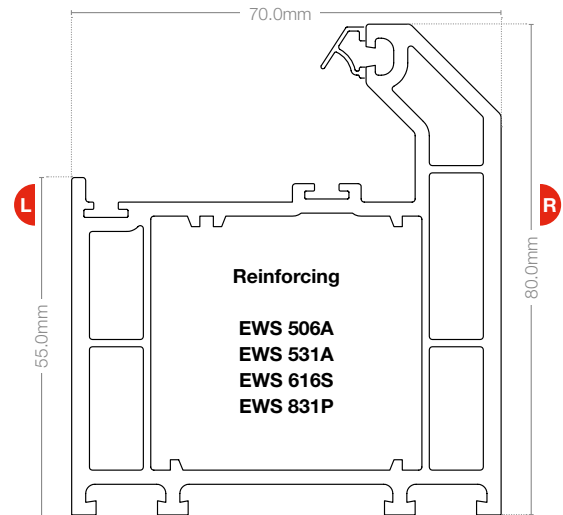

Large composite door frame  
**EWS 031**

### CILLS

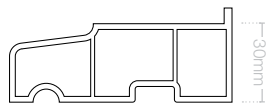

85mm A type cill  
**AS 85**

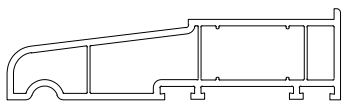

125mm cill  
**AC 125**

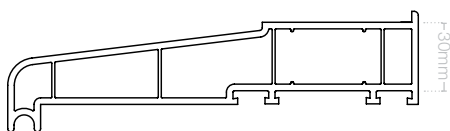

150mm A type cill  
**AC 150**

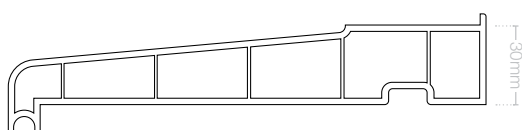

180mm A type cill  
**AC 180**

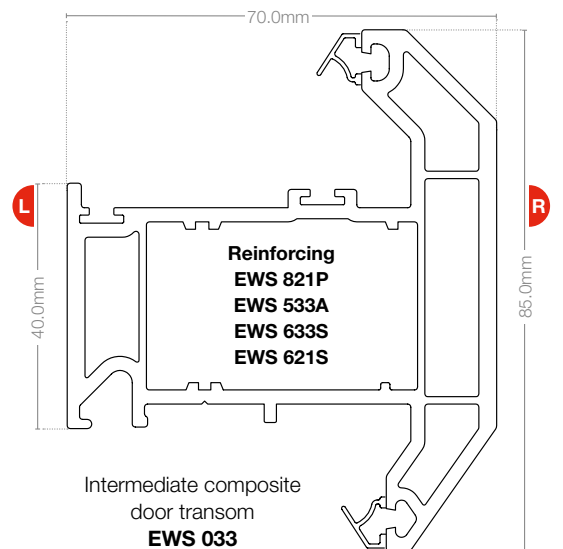

Intermediate composite door transom  
**EWS 033**

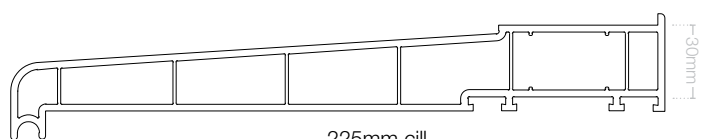

225mm cill  
**AC 225**

**THRESHOLDS**

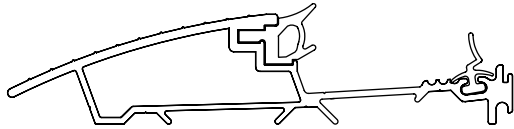

Part M low threshold  
**MDS 25**

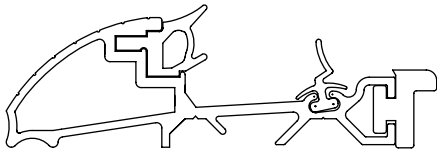

Inward open low threshold  
**MDS 83**

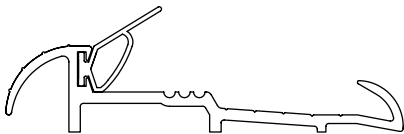

Outward open low threshold  
**OUM 4**

Outerframes **EWS 031** and **EWS 032** can also be used if PVC-U threshold is required.

**BEADS, GASKETS & WOOLPILE**

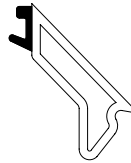

**EWS 7301**  
(glass)



**EWS 431G**



**9257**

**ALUMINIUM COMPONENTS**

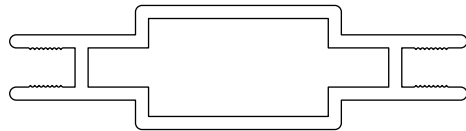

**EWS 510A**

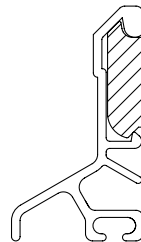

Weather deflector

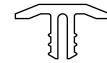

T capping section  
**EWS 107**

**REINFORCINGS & PVC-U THERMAL INSERTS**

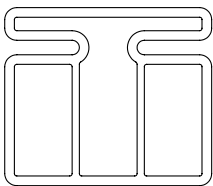

**EWS 831P**

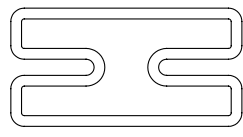

**EWS 832P**

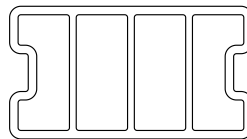

**EWS 821P**

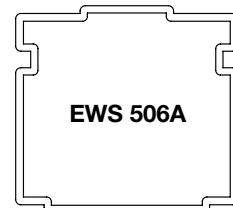

**EWS 506A**

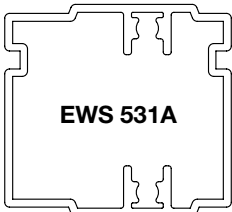

**EWS 531A**

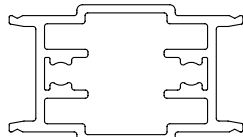

**EWS 533A**

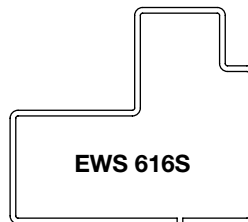

**EWS 616S**



**EWS 633S**

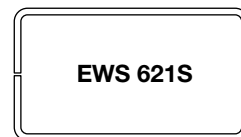

**EWS 621S**

# the dales collection®

## COMPOSITE DOOR STYLE OPTIONS

### DOOR STYLES



**The Brassington**



**The Bradbourne**



**The Chatsworth**  
Solid also available



**The Middleton**  
Solid also available



**The Cromford**



**The Wirksworth**  
Solid also available



**The Thorpe**  
Solid also available



**The Winster**



**The Chelmortton**



**The Litton**



**The Hathersage**



**The Bretton**

**GLASS OPTIONS**



**Solid**



**Andaman**

Triple-glazed  
(no backing  
glass required)  
Gold or Silver leading



**Bevel Diamond**

Double-glazed  
Standard leading only  
Available in Clear Bevel,  
Red, Blue, Green  
and Black

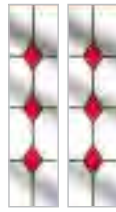

**Diamond**

Double-glazed  
Standard leading only  
Available in Clear Bevel,  
Red, Blue, Green  
and Black



**Diamond Classic**

Triple-glazed  
(no backing glass required)  
Silver leading



**Spirit**

Double-glazed  
Standard leading only



**Prestige**

Double-glazed



**Silvaner**

Double-glazed



**Eos**

Double-glazed



**Kara**

Triple-glazed  
(no backing glass required)  
Gold or Silver leading



**Lattice**

Double-glazed  
Standard leading only



**Mene**

Double-glazed



**Murano**

Double glazed  
Available in Red, Blue,  
Black and Green



**Standard**

Double-glazed  
Clear or obscure  
(available in 14 style )



**Gavalos**

Double-glazed

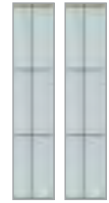

**Block Lead**

Double-glazed

For the full range of glass options for each door style, please refer to The Dales Collection brochure

**DOOR FURNITURE**

**Letterboxes**



**Numbers**



**Lever handle**



**Knockers**

Available with or without  
integrated spyhole



**Door chain**



**Spyhole**



**Bar handle**



**Slimline Knocker**

Available with or without  
integrated spyhole



**Colour key**  White  Satin Silver  Chrome  Gold  Satin Black

**BACKING GLASS**

Improve the privacy of the glass by selecting a backing glass from the range above or choose clear for a fully opaque finish. Not available with triple-glazed glass styles



**Clear™**



**Stippolyte™**

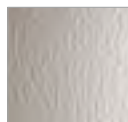

**Minster™**



**Oak™**



**Pelerine™**



**Chantilly™**



**Mayflower™**



**Autumn™**



**Contora™**



**Cotswold™**



**Everglade™**



**Florielle™**



**Taffeta™**



**Charcoal Sticks™**



**Satin**

© Images reproduced by permission of Pilkington plc



**skypod**<sup>®</sup>

## LANTERN ROOFS

### Eye-catching, affordable and easy-to-install PVC-U lantern roofs

The Skypod lantern roof system enables you to create an eye-catching, contemporary feature that floods the interior of a property with natural light. It brings life and freshness to uninspiring flat-roofed buildings, and makes a stunning alternative to conventional conservatory roofs.

Skypod skylights add height, light and volume to any living space. They are the perfect choice for refurbishment, extension or new-build projects, enhancing rooms from reception areas, classrooms and orangeries to kitchen-diners and garage conversions.

### **Affordable, energy efficient, attractive – the perfect alternative to aluminium**

Eurocell designed Skypod as an affordable alternative to aluminium skylights, making them a viable option for a wider range of applications and budgets. As well as being costly, aluminium has an 'industrial' appearance that is unsuited to many properties and not to everyone's taste.

Skypod offers significant energy-efficiency improvements over aluminium too, with a U-value as low as 1.0\* – helping to reduce energy bills. PVC-U cappings help to match the appearance of skylights to existing PVC-U windows and doors.

The architectural design of Skypod means there are no fussy crests or finials to fit, providing clean, unobstructed sightlines. A unique ridge end cover cap completes the sleek appearance.



## **Create skylights up to 2.75m x 8.7m**

Skypod is available in a wide range of sizes, so you can create a skylight suitable for any project. With five design options to choose from, you can tailor Skypod to meet the needs of individual projects.

## **Simple, quality-assured installation**

Skypod has been designed for fast, accurate, simple installation. It requires only square cuts, with no mitring or awkward angles to negotiate, and all screw holes are pre-drilled. This ensures a precision-fitted watertight skylight on every job.

\* Standard U-value is 1.2. U-value is applicable to glass only.



**skypod<sup>®</sup>**

LANTERN ROOFS

## FEATURES AND BENEFITS

- ▶ Contemporary architectural design adds height and volume to the smallest of rooms.
- ▶ Simple clean lines with no crestings or finials. Unique ridge bar cover cap maintains a minimalist appearance.
- ▶ Exceptional energy efficiency – with a U-value of 1.0 achievable (glass figure).
- ▶ Choice of frame colours, with self-cleaning temperature-controlled glass available in blue, neutral, bronze or clear.
- ▶ Fixed roof pitch of 20° in three or two-bar Skypod option.
- ▶ Acute angled 35° pitch available for larger skylights, ideal for education and commercial buildings.
- ▶ Ten-year product guarantee for your peace of mind.
- ▶ Comprehensive range of sizes up to 2.75m x 8.7m\*.
- ▶ Ready-to-install kit includes all screws and fixings to complete the installation.

## Colour options

Like all Eurocell PVC-U products, Skypod comes with an exact colour-match guarantee – meaning the colours are precisely matched with all Eurocell window, door and conservatory roof products.

Skypod has a white internal finish as standard, to maintain a bright, fresh interior. A range of external frame colours and glass options is available to tailor the skylight for each project.





## FRAME COLOURS



**WHITE**  
White interior



**ANTHRACITE GREY**  
White interior



**ANTHRACITE GREY**  
Anthracite interior



**MOONDUST GREY**  
White interior



**ROSEWOOD**  
White interior



**GOLDEN OAK**  
White interior

## GLASS COLOURS



**BLUE**



**NEUTRAL**

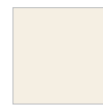

**BRONZE**



**AQUA**



**CLEAR**

**ADDITIONAL COLOURS AND SPECIFICATIONS ARE MADE TO ORDER ON EXTENDED LEAD TIMES**



## PRODUCT RANGE

FIVE SKYPOD LANTERN ROOF STYLES ARE AVAILABLE

### No side rafter bars

With the fewest possible slimline bars required to create uninterrupted glazed surfaces of up to 1.5m x 2.75m, Skypod with no side rafter bars is the cleanest, simplest way to introduce overhead natural light into any room. It offers a practically unobstructed window on the world above and, come rain or shine, keeps interiors warm and comfortable thanks to temperature-controlling glass and superior energy efficiency.

### With side rafter bars

By introducing additional bars to the standard Skypod design, side rafter bars extend the size possibilities for fully glazed rooflights to spans of up to 1.5m wide x 7.45m long. The result is a dazzling feature roof that can turn underwhelming flat-roofed extensions into year-round living spaces with plenty of natural light and lofted headroom.



Skypod with no side rafter bars

## Three-bar gable

The extra strength and rigidity of the three-bar Skypod option allows you to create even longer, wider vaulted rooflights. It gives a more traditional 'orangery' look to your lantern roof, with classically proportioned end panels in a spacious vaulted glass feature up to 2.75m wide x 8.7m long.

## Skypod SQ

An alternative to the single span rectangular rooflight, Skypod SQ is a square skylight that offers perfectly balanced sightlines. Thanks to its simple four-hip design, it provides higher levels of natural light than conventional designs of the same surface area. Because Skypod SQ can be produced in sizes as small as 0.5m x 0.5m, it means even the smallest flat-roofed space can benefit from enhanced natural light.

## Skypod Acute

With a pitch angle of 35°, Skypod Acute offers all the aesthetics of traditional aluminium-framed skylights or lantern roofs, with the cost and energy-efficiency benefits of PVC-U. It is ideally suited for creating larger raised skylights to bring natural light into flat-roofed reception areas, offices or classrooms.



With this 3-bar gable design, you can create larger skylights



Skypod SQ

skypod<sup>ACUTE</sup>



# TECHNICAL INFORMATION

## SKYPOD LANTERN ROOFS

### COMPONENTS

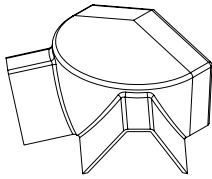

**CRS 9241**  
Skypod 2-bar top cap

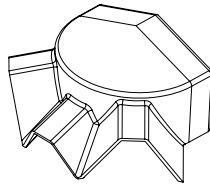

**CRS 9240**  
Skypod 3-bar top cap

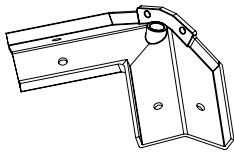

**CRS 9522A**  
Skypod 2-bar spider bracket

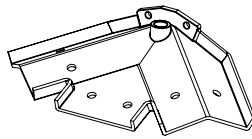

**CRS 9521A**  
Skypod 3-bar spider bracket

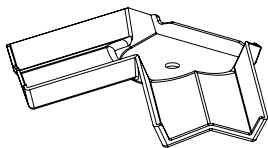

**CRS 9249**  
Skypod 2-bar bottom cap

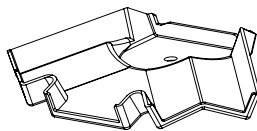

**CRS 9248**  
Skypod 3-bar bottom cap

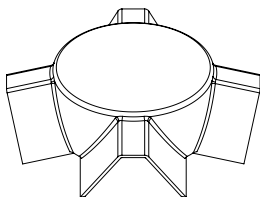
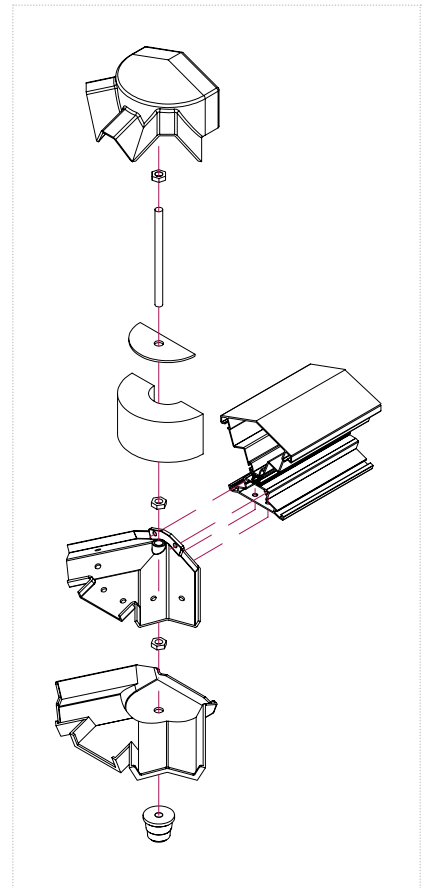

**CRS 9242**  
Skypod SQ top cap

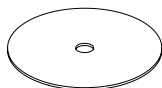

**CRS 9423**  
Skypod SQ foam bung sealing plate

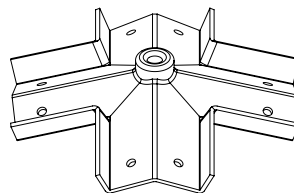

**CRS 9523A**  
Skypod SQ spider bracket

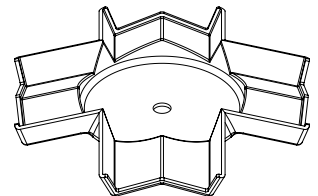

**CRS 9250**  
Skypod SQ bottom cap

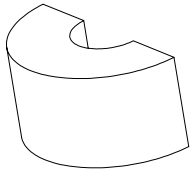

**CRS 9421**  
Skypod foam bung

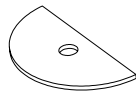

**CRS 9422A**  
Skypod foam  
bung sealing plate

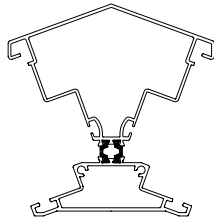

**CRS 9520A**  
Skypod  
ridge body



**CRS 8625**  
Single variable  
support stud

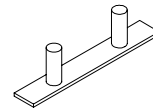

**CRS 8624**  
Double variable  
support stud



**CRS 8534A**  
M10 decorative  
boss

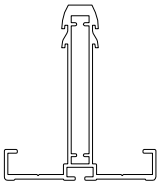

**CRS 8501A**  
Standard rafter

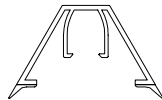

**CRS 8016**  
25mm  
rafter top cap

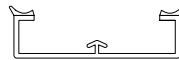

**CRS 8011**  
Rafter bottom cap

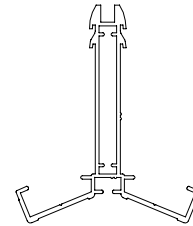

**CRS 8502A**  
Edwardian hip

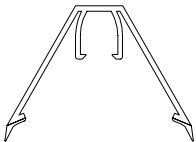

**CRS 8017**  
25mm Edwardian  
hip top cap

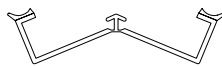

**CRS 8012**  
Hip bottom cap

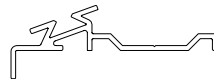

**CRS 9550A**  
Skypod eaves 20°



**CRS 8053**  
Eaves beam seal

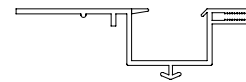

**CRS 8024**  
24/25mm ridge  
glazing trim

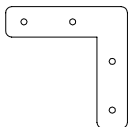

**CRS 8654**  
90° eaves  
beam cleat

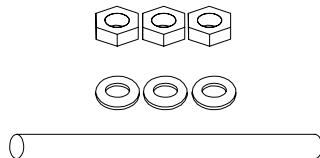

**CRS 8034**  
M10 nylon  
threaded bar

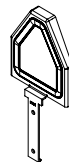

Rafter / hip end cap  
**CRS 8201**

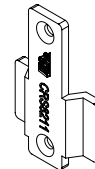

Glazing stop  
**CRS 8211**

Glazing stop  
screws (for  
glazing stop)  
**CRS 8628**

# TECHNICAL INFORMATION

## SKYPOD LANTERN ROOFS

### ASSEMBLIES

#### Ridge assembly

Powder-coated aluminium, thermally broken

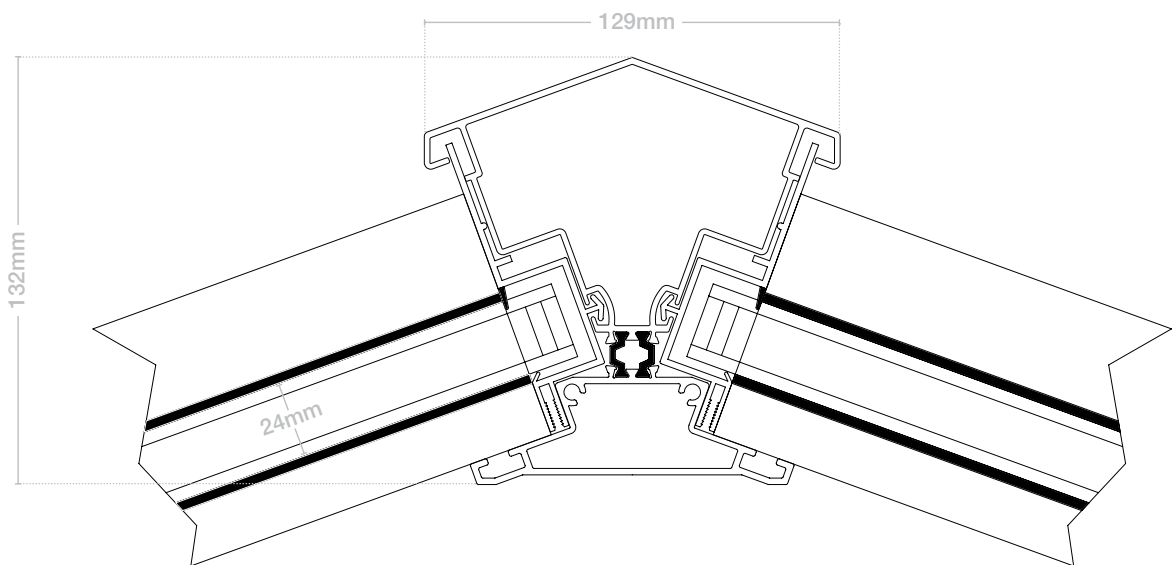

#### Rafter assembly

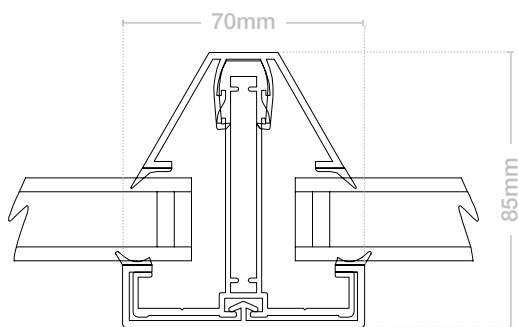

#### Hip assembly

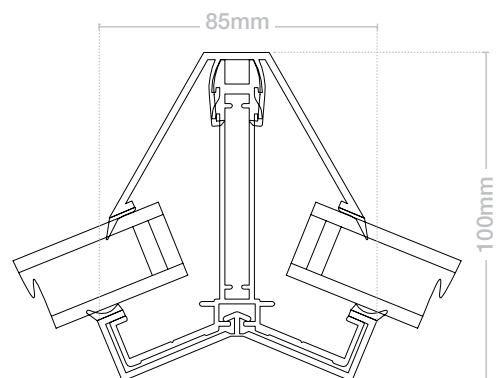

### INSTALLATION

To see an in-depth installation guide, please contact our Customer Care Team on **0800 988 3047**



CHOICE OF  
**TILES &**  
COLOURS

MULTI-LAYERED  
**ROOF DESIGN**

**equinox**<sup>®</sup>

TILED ROOF SYSTEM

## Transform under-used conservatories into year-round living spaces

Everyone loves the extra space and light offered by a conservatory, but fluctuating temperatures can often make them uncomfortable – too hot in summer and too cold in winter.

The market-leading Equinox tiled roof product offers the perfect solution to this problem. It enables you to transform under-used conservatories into valuable extra living space that can be used year-round – without the high cost of building an extension.

**Superb looks and outstanding energy efficiency**

As well as offering more colour options than alternative tiled roof systems, Equinox offers a choice of realistic slate-effect or steel tile finishes. A selection of roof windows means you won't be sacrificing the natural light that makes conservatories so appealing.

The exceptional energy efficiency of the Equinox roof system also helps to keep rooms at a comfortable temperature all year round. It offers U-values as low as 0.148 – achieved thanks to a multi-layered design which also prevents moisture build-up in the roof space and eliminates condensation.

### **Simple, rapid installation – every time**

Equinox incorporates a range of innovative features such as pre-positioned ring-beam nuts and bolts, along with minimal components to ensure that installation is fast, accurate and causes minimal disruption. A unique tile sheet is available so that tiles don't need to be fitted individually – further accelerating installation times. In fact, a whole roof can be fitted in as little as 48 hours. What's more, the roof is watertight on day one, so it can safely be left overnight.





**0.15\***  
U-VALUE

VARIABLE  
**10-35°** PITCH

**5°-35°**  
COVERS MOST  
LEAN-TO-DESIGNS  
– **UNIQUE**

### **SlateSkin GRP sheet tile system – installed in half the time**

Equinox is available with the innovative new SlateSkin GRP sheet tile system. These large sheets of tiles have all the looks of composite slate tiles, but allow roof tiling to be completed up to 50% faster.

### **Intelligent design provides multiple roof options**

Equinox offers variable pitches between 5°\* and 35 degrees, giving you a wider range of roof options. A reduced ring-beam overhang means there are no problems with replacing conservatory roofs on boundary lines – and no loss of strength. There are no load-bearing issues either, thanks to the internal roof support structure, making Equinox fully compliant with Building Regulations Part L. A gable end component allows improved aesthetics for gutters on gable end designs.

The SlateSkin GRP sheet tile system enables a 5° roof pitch to be achieved. This means that virtually all lean-to conservatories can now be fitted with an Equinox roof – a significant market development and something not currently possible using any other tile system.

Advanced features for improved performance and aesthetics Purpose-designed components such as flush-fitting rafters, box gutters and a variable ring beam, provide an attractive clean-lined finish to any Equinox roof. The superior aesthetics extend to the interior too, with a contemporary plastered internal finish and a choice of plasterboard or tongue-and-groove timber ceiling.

### **Versatile roof for a range of rooms**

Equinox isn't just a great system for conservatory roofs. This versatile solution can be used to transform flat roofs – whether on a new extension or an existing roof. Even porches can benefit from a contemporary Equinox makeover.

\* 10° pitch subject to tile type.



**equinox<sup>®</sup>**

**TILED ROOF SYSTEM**

**Colour options**

Equinox roof fascias are precisely colour-matched to all Eurocell window, door and conservatory roof products, so you can create a coordinated, consistent look across any property.



**FASCIA COLOURS**



WHITE CREAM GOLDEN OAK IRISH OAK



ROSEWOOD CHARTWELL GREEN ANTHRACITE GREY BLACK ASH

Additional colours are made-to-order on extended lead times

**GUTTERING COLOURS**



WHITE CLAY BROWN BROWN BLACK

## FEATURES AND BENEFITS

- ▶ Ring-beam assembly with variable pitch from 5° to 35° increases the types of roof that can be replaced.
- ▶ Variable pitch wall assembly for greater flexibility.
- ▶ Box gutter assembly designed for easier installation, improved aesthetics and performance.
- ▶ Solid roof support system for enhanced structural support, where required.
- ▶ Multi-layer roof design to prevent condensation, reduce noise and enhance energy efficiency.
- ▶ Interior aesthetic options include traditional plastered or tongue-and-groove timber ceilings.
- ▶ Recyclable composite tiles offer traditional looks without the risk of shattering, fading, warping or cracking.
- ▶ Wide choice of colours for both slate-style and standard steel tiles.
- ▶ SlateSkin sheet slate tiles offer authentic slate-effect appearance in large sheets to accelerate roof tile fitting.
- ▶ Designed for fast installation – with all ring-beam nuts and bolts ready positioned. Tiled roofs can be installed in just two days with a three-man team.
- ▶ One-box solution with all sealants and fixings required to install the roof to the highest standard.

## STEEL TILES

High-quality steel tiles come as standard, and are made from lightweight steel in a choice of colours

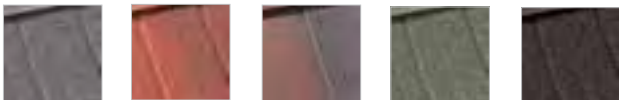

CHARCOAL

ANTIQUÉ RED

BURNT  
UMBER

MOSS GREEN

EBONY

## COMPOSITE SLATE TILES

Made from a recyclable mix of limestone and polypropylene, composite tiles offer traditional looks without risk of shattering, fading, warping or cracking.



BRICK RED

PEWTER GREY

STONE BLACK

CHESTNUT

PLUM

## SLATESKIN GRP SHEET SLATE TILES

This authentic slate-effect sheet tile allows you to tile an Equinox roof up-to 40% faster than steel or composite slate tiles. Sheet size 4000mm x 400mm or 6000mm x 400mm.



SLATE GREY

# equinox<sup>®</sup> TECHNICAL INFORMATION

## ROOF SYSTEM CROSS-SECTION

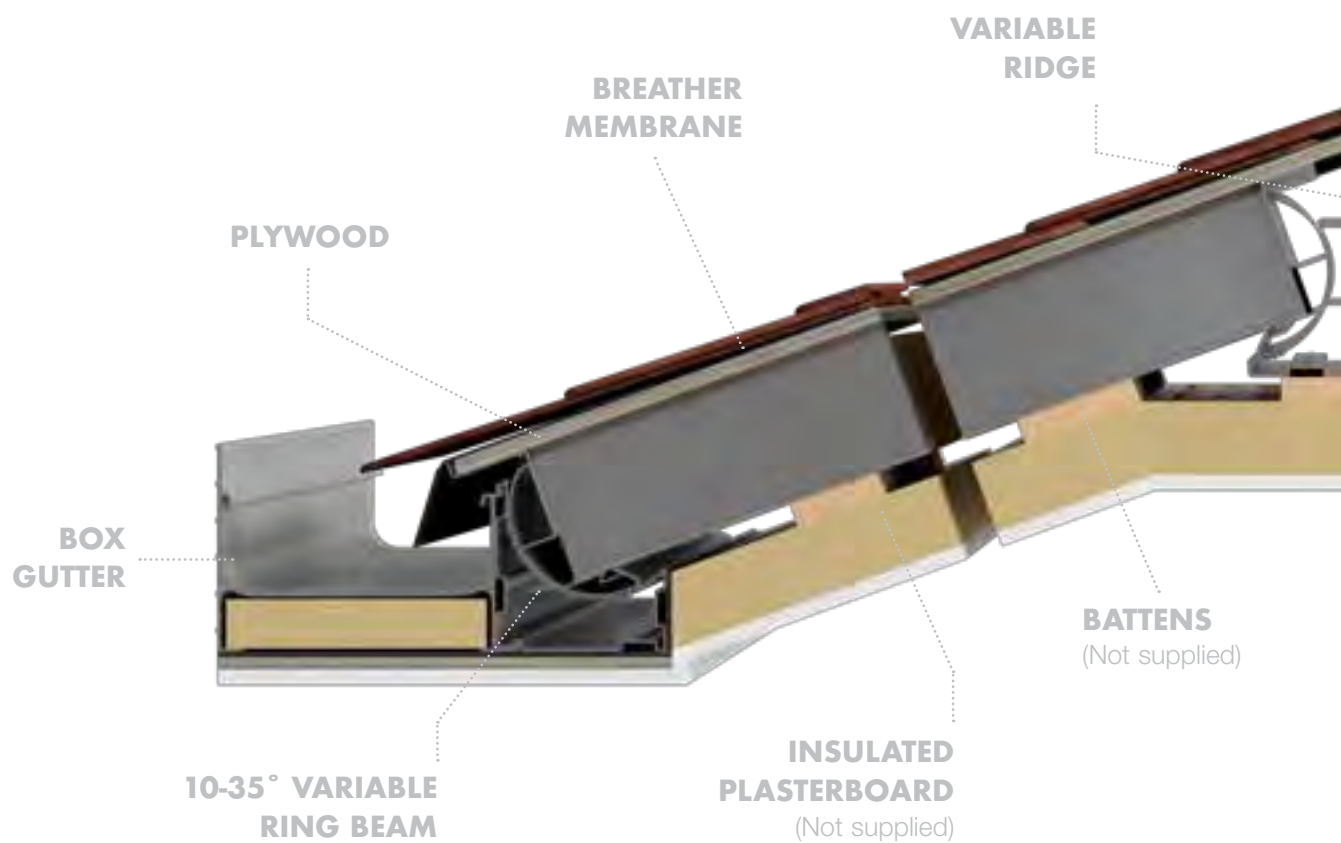

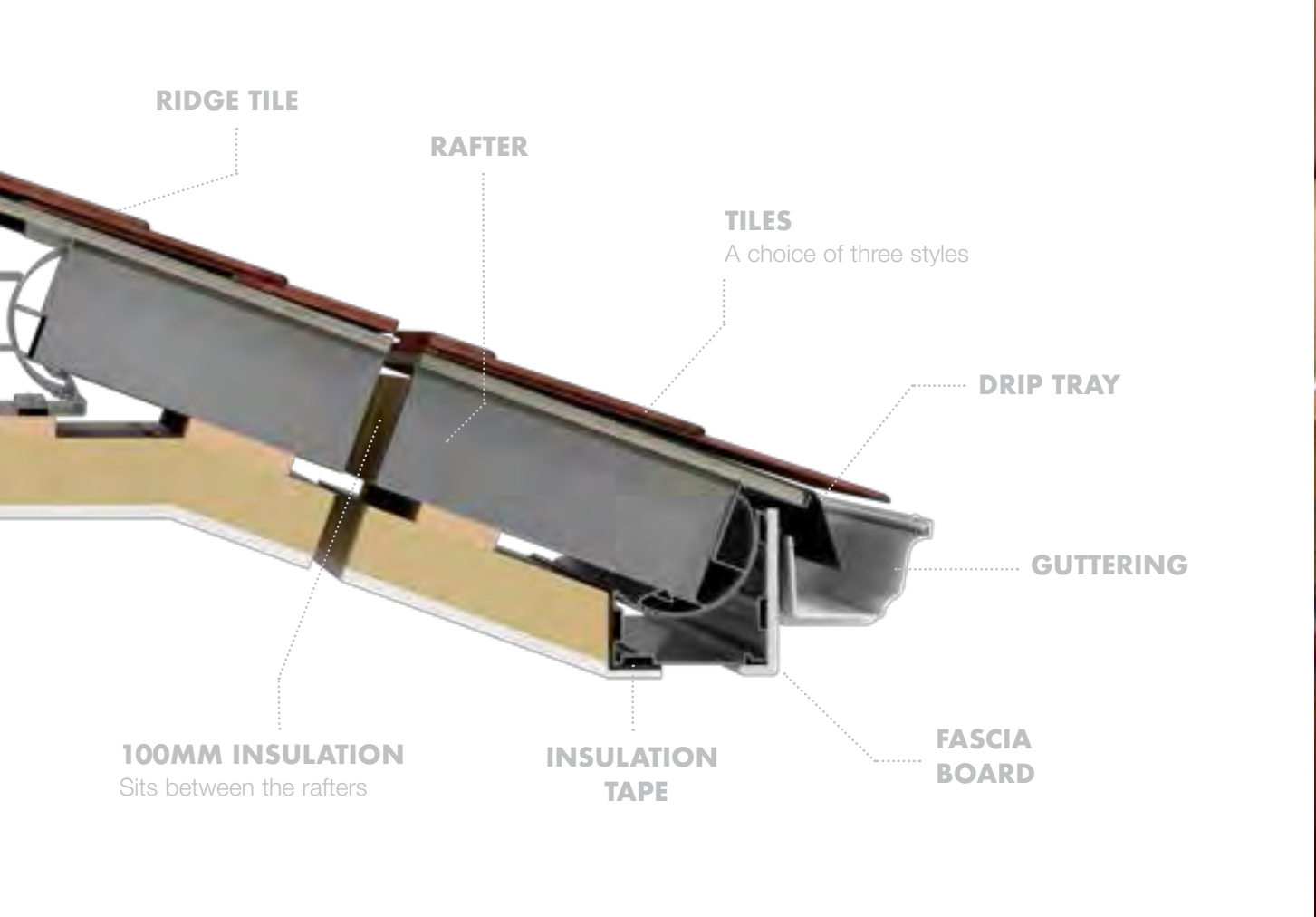



## CONSERVATORY ROOF SYSTEM

### TRADITIONAL CONSERVATORIES

From classical to contemporary, Eurocell conservatory roof systems create desirable living spaces for any property



Conservatories are the ideal way to extend any home, providing bright, airy rooms that connect indoor and outdoor spaces, and give valuable extra living space.

Eurocell offers a full range of conservatory roof systems, fully compatible with all our high-performance doors and windows – enabling you to create a complete conservatory from Eurocell products.

### **Designed for faster, smoother installation**

Designed for speed and ease of installation and fabrication, the Eurocell conservatory roof system is one of the most advanced and user-friendly on the market.

## FEATURES AND BENEFITS

### Roof glazing

- ▶ Roof pitches between 2.5° and 45° in 24mm glass or 25/32mm polycarbonate.
- ▶ Patented ridge end sealing assembly reduces the risk of water ingress and overcomes the need for silicone sealing.
- ▶ Incorporates glass retention system as standard on every roof design.
- ▶ The ridge top cap can be fitted and lead work completed before glazing, making it quicker and easier to achieve watertight installations.
- ▶ Aesthetically designed, maintenance-free aluminium and PVC-U ridge cresting and finials available.
- ▶ Fully foiled ridge top capping for all woodgrain installations.

### Glazing bars

- ▶ A built-in rafter gutter system is supplied as standard, for neat and leak-free lead flashing against house walls.
- ▶ Jack rafter locations allow four-way adjustment on-site to ensure neat connections.
- ▶ Simple, neat clip-up-and-over rafter end caps are great for box gutters or where access is limited.

### Box gutters

- ▶ High-strength standard box gutters never require additional internal strapping – even for glass.
- ▶ Silicone-free box gutter adaptors make for easy leak-free all-weather installation.
- ▶ Box gutters are cut square to the external face of the frames below, rather than mitred over them – minimising any risk of internal leakage.

### Guttering

- ▶ Ogee guttering sits clear in front of eaves beam – reducing any risk of overflow leaks.

### Roof vents

- ▶ Manual or electric roof vents can be incorporated into roof designs, as well as a climate-control system that automatically opens and closes the vents.

## Roofs to suit all building types

Eurocell can supply the components to create outdoor rooms of any style, size or configuration. Our bespoke conservatory roof enables you to fabricate any conservatory design, or you can choose from our range of classic styles, including Victorian, Edwardian and gable-ended conservatories. For a more cost-effective, but equally high-quality conservatory roof, you can choose our lean-to style.

## Glass or polycarbonate options

The Eurocell conservatory roof system is suitable for glass roof installation. Two glass types are available for conservatory roofs – standard toughened and high-performance Perfect Day glass, featuring a revolutionary dual-action self-cleaning coating as standard. Activated by sunlight and rain, the self-cleaning coat lasts the lifetime of the glass. A solar-control option is also available, which reduces heat build-up without costly air conditioning.

Multi-wall polycarbonate is a popular alternative to glass, available in a choice of colours and thicknesses, providing different levels of thermal efficiency. This lightweight material offers extra heat and noise insulation, as well preventing glare.

### Crestless ridge option available Autumn 2016





# CONSERVATORY ROOF SYSTEM

TRADITIONAL CONSERVATORIES

## PROFILE COLOURS

STANDARD

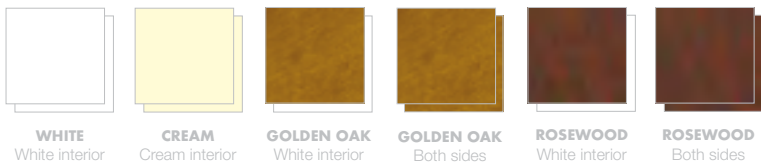

MADE TO ORDER

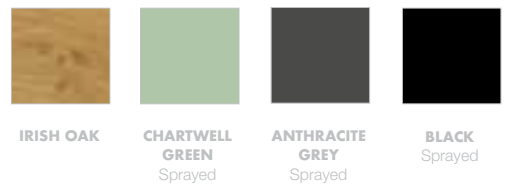

## GLASS COLOURS

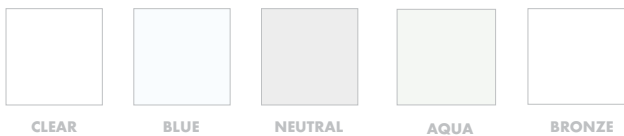

## POLYCARBONATE COLOURS

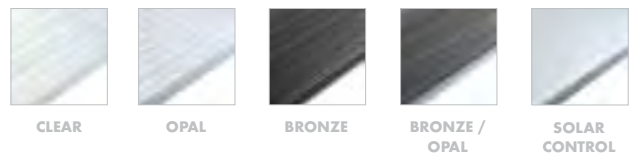

ADDITIONAL COLOURS ARE MADE TO ORDER ON EXTENDED LEAD TIMES



## STYLES



### Edwardian

Bold, square-fronted projection, styled to reflect the elegant and dignified simplicity of the Edwardian era.



### P-shaped

A combination of two conservatory styles (e.g. lean-to and Edwardian) offering greater flexibility and a multi-functional space.



### Victorian

Distinctive multi-faceted projection, with a choice of three or five facets, creating a classically styled addition to any property.



### Lean-to/ reverse lean-to

A cost-effective way to add a spacious conservatory to any property, with the reverse style adding an eye-catching contemporary twist.



### Gable-ended

Featuring a projection in the same shape as the gable end of a conventional house, with the vertical end wall meeting the ridge of the roof. This style maximises available space.



### Bespoke contemporary

Eurocell can help you to design bespoke conservatoires for specific projects using our advanced and versatile conservatory roof system.

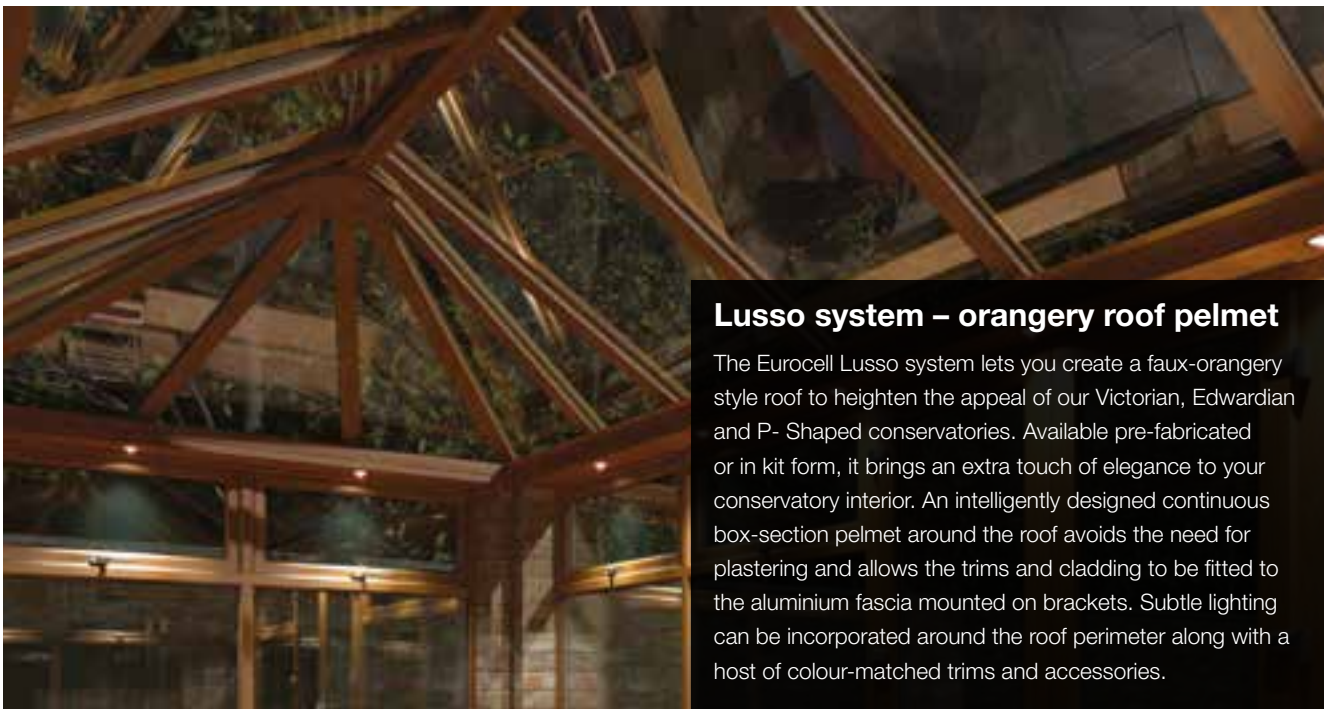

### Lusso system – orangery roof pelmet

The Eurocell Lusso system lets you create a faux-orangery style roof to heighten the appeal of our Victorian, Edwardian and P- Shaped conservatories. Available pre-fabricated or in kit form, it brings an extra touch of elegance to your conservatory interior. An intelligently designed continuous box-section pelmet around the roof avoids the need for plastering and allows the trims and cladding to be fitted to the aluminium fascia mounted on brackets. Subtle lighting can be incorporated around the roof perimeter along with a host of colour-matched trims and accessories.

# TECHNICAL INFORMATION

## CONSERVATORY ROOF MAIN ASSEMBLIES

### RAFTER & HIP ASSEMBLIES

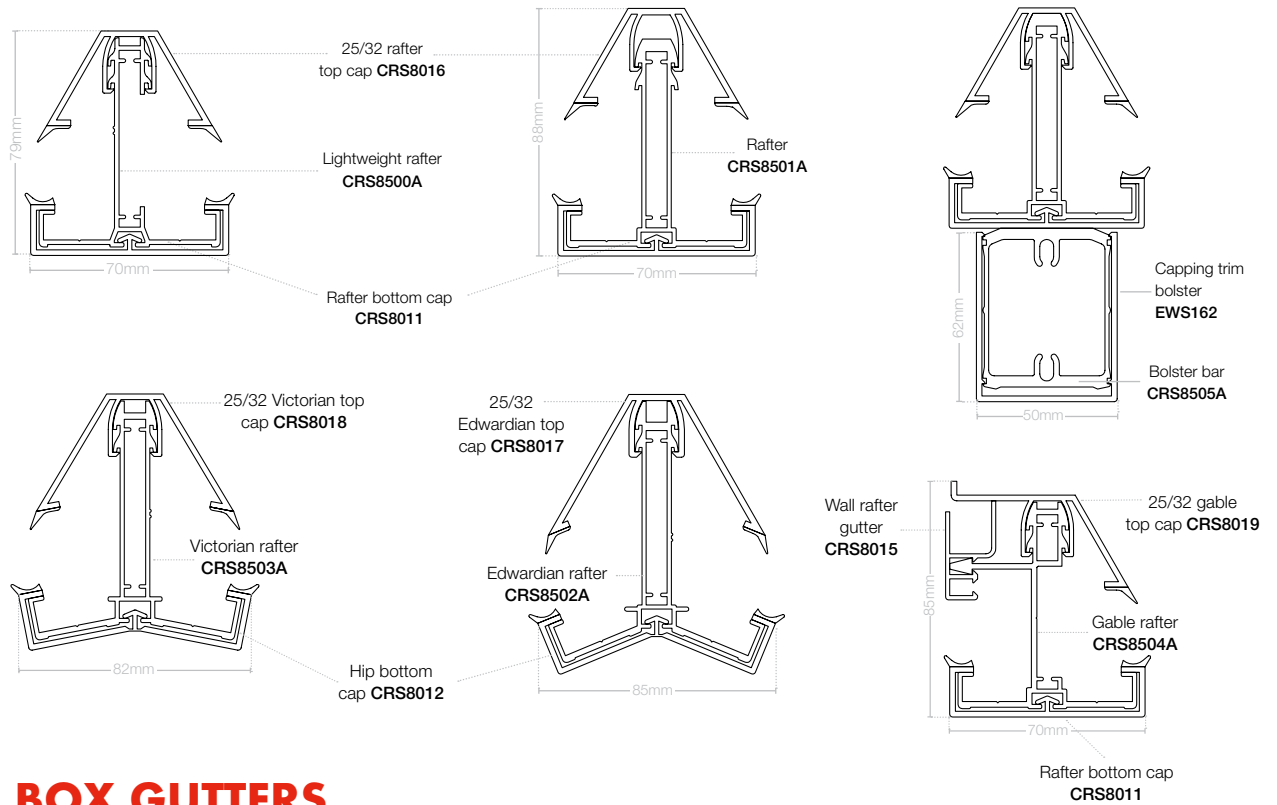

### BOX GUTTERS

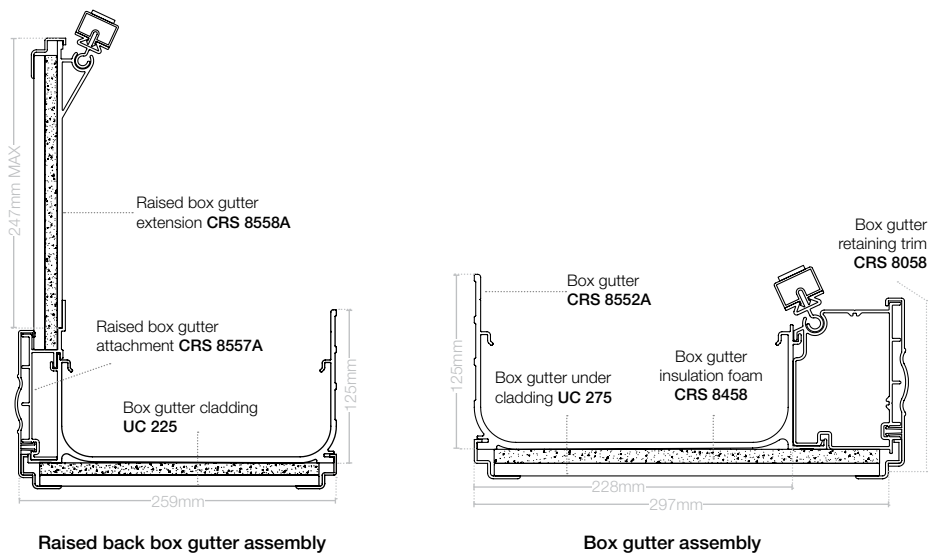

## VALLEY & RIDGE ASSEMBLIES

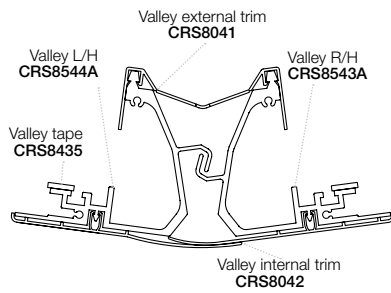

Valley assembly

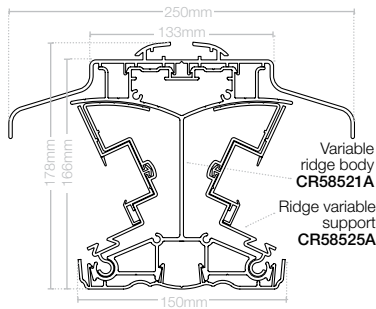

15-45° variable ridge assembly

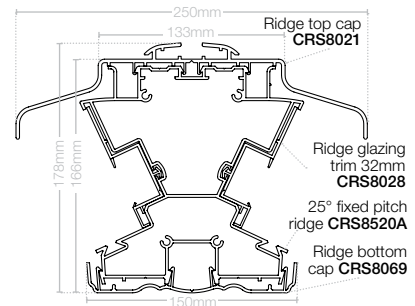

25° fixed pitch ridge assembly

## RING BEAMS

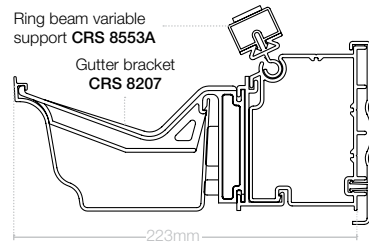

2.5-45° variable ring beam

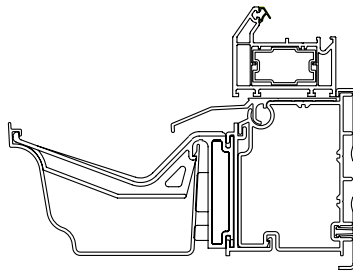

Gable ring beam assembly

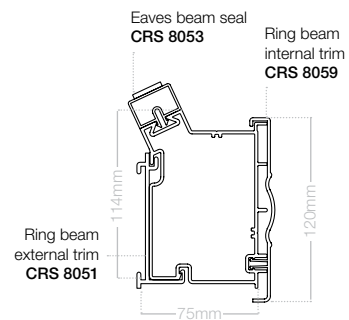

25° fixed ring beam

## LEAN-TO WALL PLATES

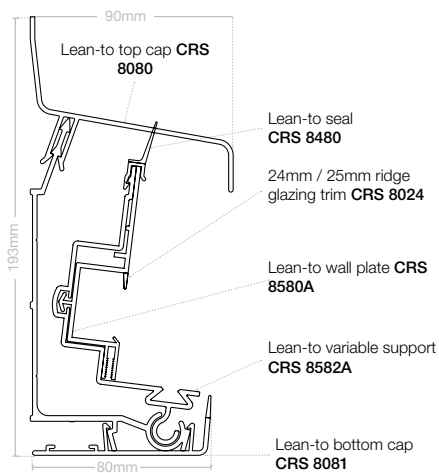

2.5°-15° lean-to wallplate assembly

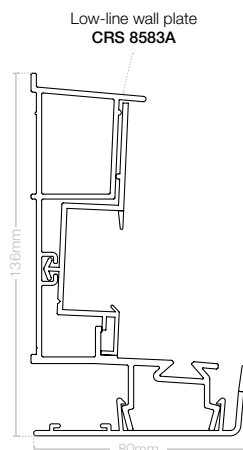

2.5°-5° low-line wallplate assembly

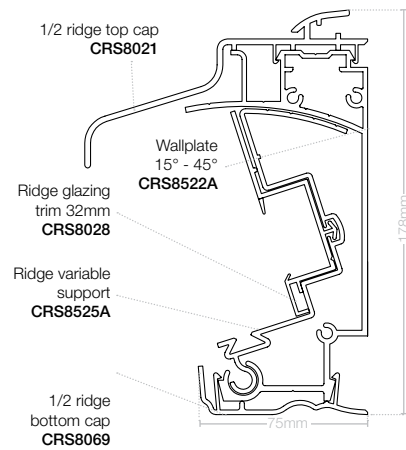

15°-45° lean-to wallplate assembly

# TECHNICAL INFORMATION

## CONSERVATORY ROOF SYSTEM COMPONENTS

### PVC-U COMPONENTS

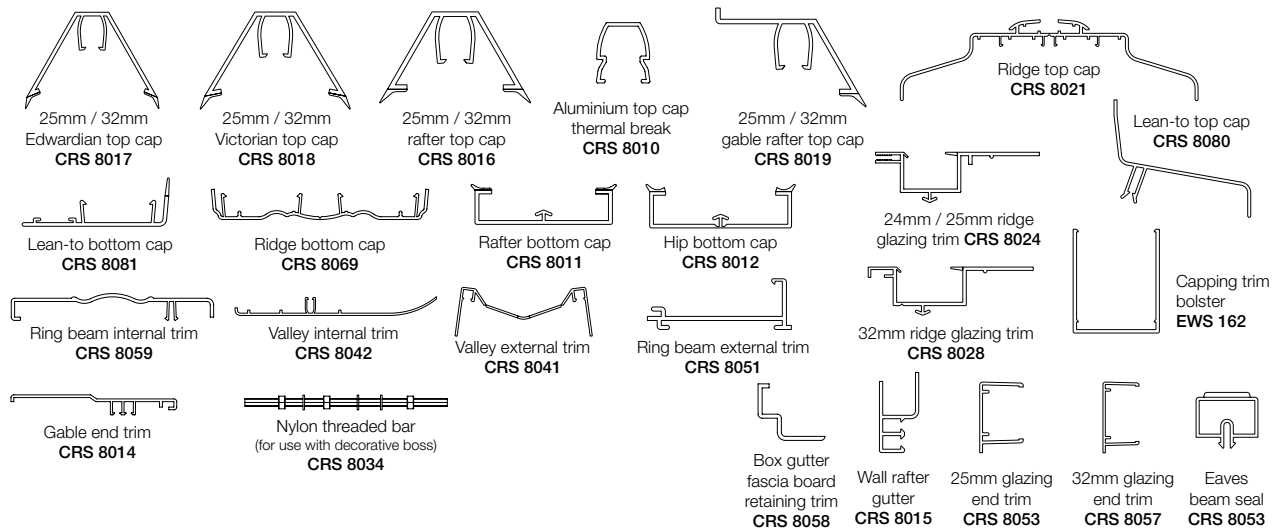

### MOULDINGS

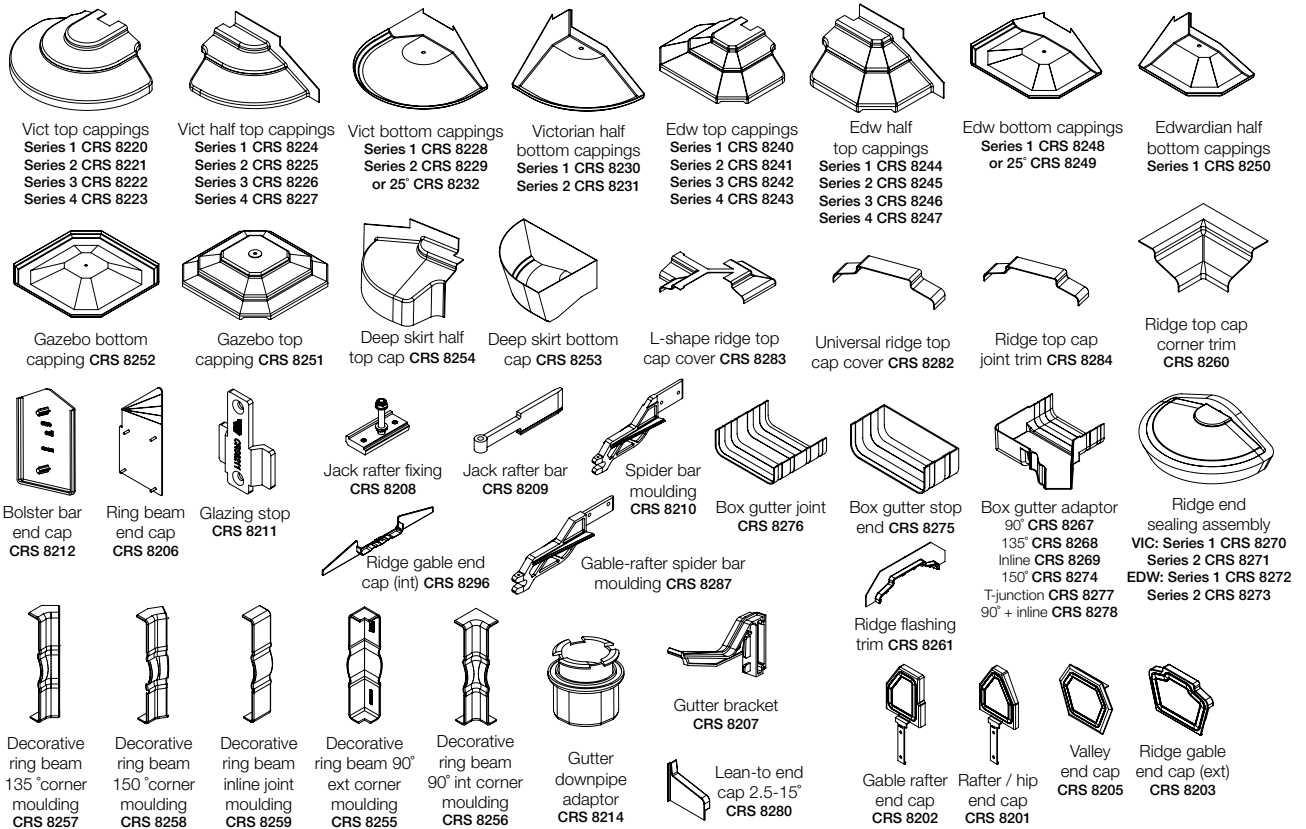

## ALUMINIUM COMPONENTS

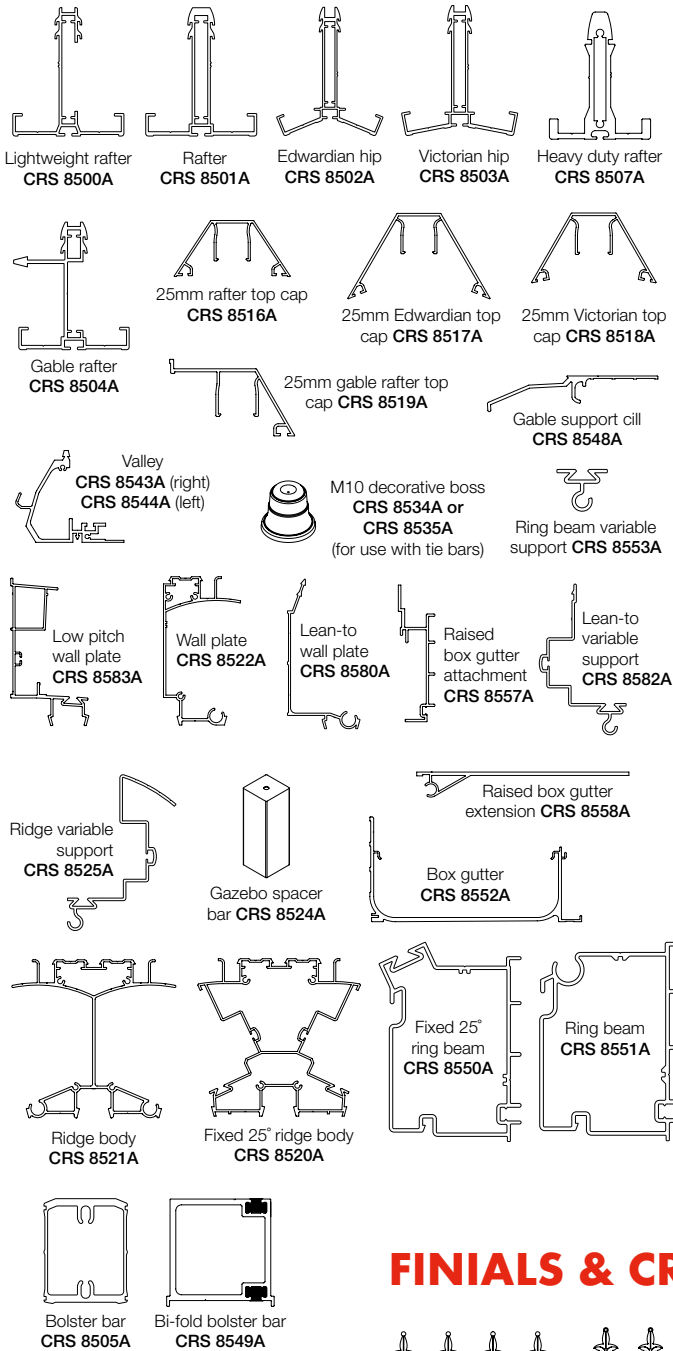

## STEEL COMPONENTS

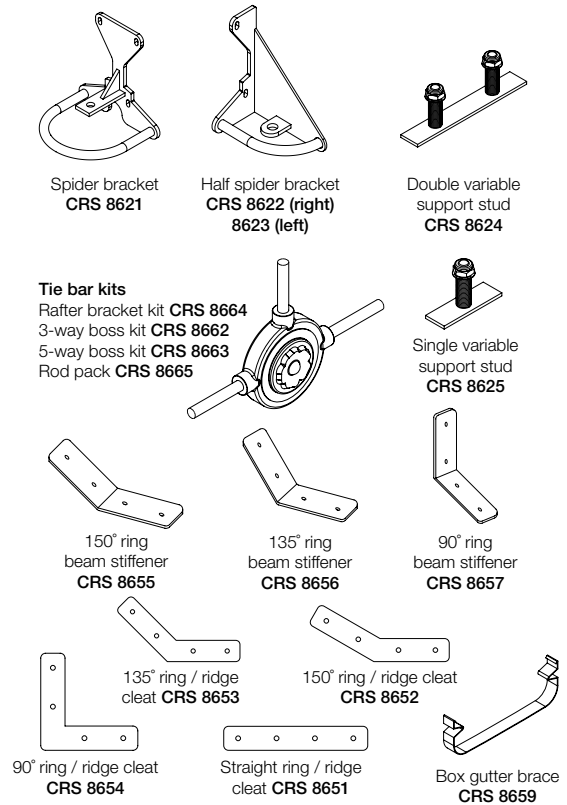

**ALSO AVAILABLE** (no drawings available)

Polytop screws (for ridge to cap) CRS 8627  
Spider bar screws (for ridge to spider) CRS 8626  
Glazing stop screws (for glazing stop) CRS 8628

## MISC

Lean-to seal CRS 8480  
Aluminium rafter top cap gasket CRS 8411  
Gable support block CRS 8450  
Valley double sided tape CRS 8435  
Box gutter thermal tape CRS 8458  
Raised box gutter under cladding UC 225  
Standard box gutter under cladding UC 275

## FINIALS & CRESTINGS

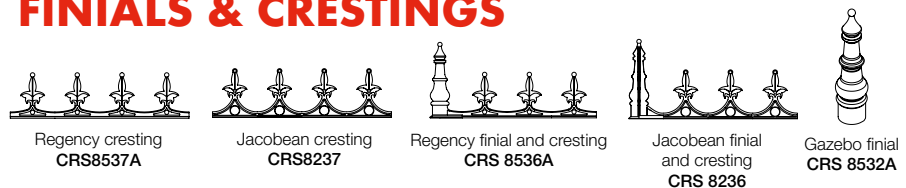

# PVC-U PROFILES

## TECHNICAL INFORMATION

### MATERIAL PROPERTIES

Material property	Requirement	Achieved
Charpy impact strength	12 Kj/m	Pass
Tensile yield stress	38 Mpa	Pass
Modulus	2250 Mpa	Pass
Tensile impact @ 23°C	600 Kj/m <sup>2</sup>	Pass
Tensile impact @ -10°C	400 Kj/m <sup>2</sup>	Pass
Vicat softening temperature	75°C	Pass
Thermal stability	85 mins	Pass
Heat reversion	2% frames 3% beads	Pass
Heat ageing	No bubbles /cracks / delamination	Pass
Low temperature impact (10°C)	No cracking through surface	Pass

#### Materials

All materials are subjected to stringent quality control procedures, to ensure the highest standards are maintained at all times.

#### Description

External grade PVC-U extrusion compound.

#### Colours

White: RAL9003

Cream: RAL1015\*

#### Application

PVC-U window profiles and glazing beads.

#### Physical properties

(Extruded profile samples)

BS: 2782 Test Methods

#### Reinforcement

Galvanised steel to BS 1449:Part 1 (CR2) and BS 2989 (Z2, Grade C). Aluminium alloy to specification 6063 or 6082, BS 1474:1987.

\* closest match

## MINIMUM AND MAXIMUM SIZES FOR WINDOWS AND DOORS

System	Width (mm)	Height (mm)
Eurologik casement windows (top hung) Espag	Max: 1200 Min: 320	Max: 1350 Min: 375
Eurologik casement windows (side hung)	Max: 750 Min: 400	Max: 1500 Min: 320
Eurologik tilt and turn windows	Max: 1500 Min: 550	Max: 1500 Min: 550
Charisma vertical sliding sash windows	Max: 1600* Min: 400 <small>*1250 for PVC-U TI</small>	Max: 2400* Min: 640 <small>*1500 for PVC-U TI</small>
Eurologik residential doors (outer to outer)	Max: 1000 Min: 800	Max: 2300 Min: 1800
Eurologik french doors (outer to outer)	Max: 2000 Min: 1200	Max: 2300 Min: 1800
Aspect panoramic doors	Max: 6000 Min: 1200	Max: 2300 Min: 1800
Eurologik fixed sizes (fixed)	Max: 3000 (combined width & height 5400)	Max: 2400

### Wind loads

The dimensions given (left) are the recommended minimum / maximum sizes for the relevant Eurocell products.

If the windows or doors to be manufactured are outside these sizes please consult Eurocell's technical department.



# PVC-U PROFILES

## TECHNICAL INFORMATION

### SAFETY GLAZING

1 The following locations may be considered 'critical' in terms of safety:

- i Between finished floor level and 800mm above that level in internal walls and partitions (diagram 1).
- ii Between finished floor level and 1500mm above that level in a door or in a side panel, close to either edge of the door (diagram 1).

#### Reducing the Risks

2. Glazing in critical locations should either:

- i Break safely, if it breaks (paragraph 3)
- ii Be robust or in small panes (paragraph 4)
- iii Be permanently protected (by screens and rails).

#### Safe Breakage

3. Safe breakage which, in practice is concerned with the performance of laminated and toughened glass, is defined in BS 6206: 1981 Specification for impact performance requirements for flat safety glass and safety plastics for use in buildings: clause 5.3. and is based on an impact test which requires the result of the impact be limited to creating:

- i A small clear opening only, with a limit to the size of the detached particles, or
- ii Disintegration, with small detached particles or
- iii Breakage resulting in separate pieces that are not sharp or pointed.

#### Robustness

4. Some glazing materials, such as annealed glass, gain strength through thickness, others such as polycarbonates or glass blocks are inherently strong. Some annealed glass is considered suitable for use in large areas forming fronts to shops, showrooms, offices, factories and public buildings.





## CRITICAL LOCATIONS IN INTERNAL AND EXTERNAL WALLS DIAGRAM

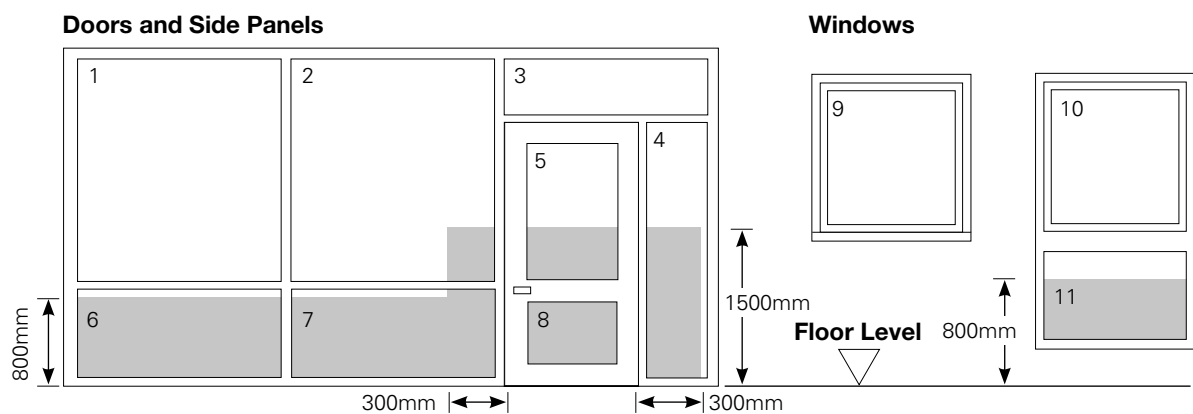

Shaded areas show critical locations to which requirement N1 applies (ie. glazing in areas numbered 2,4,5,6,7,8,11).

This data is provided for general information and to help assess what level of acoustic dampening is required of the glazed unit in the installation. More information can be found in the Building Regulations

# PVC-U PROFILES

## TECHNICAL INFORMATION

### NOISE LEVELS

Noise situation	Distance from window to centre of road (metres)	Outside sound intensity (dBA)
Motorway 3 - 5000 vehicles per hour	35	70
	100	60-70
Main town road or secondary road outside in a built up area	10	70
	35	66-70
	100	61-65
Secondary road in built up area	10	66-70
	35	61-65
	100	56-60
Residential road junction 50 - 200 vehicles per hour	10	66-70
	25	61-65
	35	56-60
	100	51-55
Residential road junction 50 vehicles per hour	10	61-65
	25	56-60
	35	51-55

Location	Recommended max level (dBA)
<b>Residential:</b>	
Bedrooms	30 - 40
Living Rooms	40 - 45
<b>Offices:</b>	
Private offices / small conference	40 - 45
Large offices	45 - 50
<b>Educational:</b>	
Classrooms (15-35 people)	40
Classrooms (35+ people)	35
Music and drama rooms	30
<b>Health &amp; Welfare:</b>	
General wards	55
Small consulting rooms	50
Diagnosis rooms	45

This data is provided for general information and to help assess what level of acoustic dampening is required of the glazed unit in the installation. This information can be found from the glass manufacturers.



## MEANS OF ESCAPE AND PROTECTION FROM FALLING, CORROSION AND IMPACT

### Emergency egress

Any window provided for emergency egress purposes and any external door provided for escape should comply with the following conditions:

- ▶ The window should have an unobstructed openable area that is at least 0.33m<sup>2</sup> and at least 450mm high and 450mm wide (the route through the window may be at an angle rather than straight through). The bottom of the openable area should be not more than 1100mm above the floor.
- ▶ The window or door should enable the person escaping to reach a place free from danger or from fire. This is a matter for judgement in each case, but in general a courtyard or back garden from which there is no exit other than through other buildings would have to be at least as deep as the dwelling is high to be acceptable, see diagram.

#### IMPORTANT INFORMATION

Approved document K, Protection from falling, collision and impact specifies a minimum guarding height of 800mm, except in the case of a window in a roof where the bottom of the opening may be 600mm above the floor.

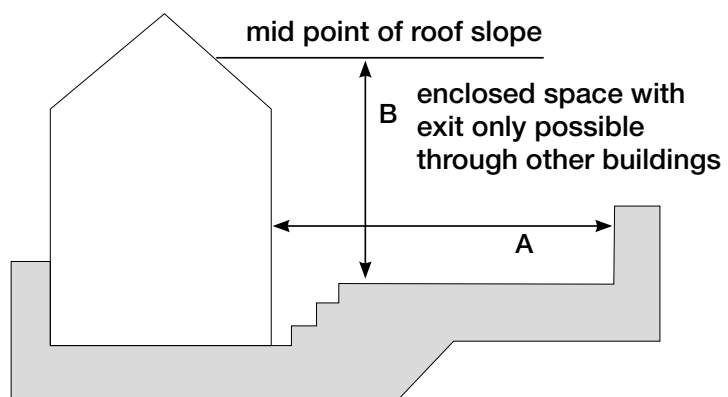

#### Ground or basement storey exit into an enclosed space

Depth of back garden 'A' should exceed the height 'B' of the house above ground level for it to be acceptable for an escape route from the ground or basement storey to open into the garden.



# PVC-U PROFILES

## TECHNICAL INFORMATION

### **CONDENSATION** REDUCING CONDENSATION ON PVC-U WINDOWS AND DOORS

#### **What is condensation?**

Condensation is water droplets that form on cold surfaces when humid air is in contact with it.

As our homes become more thermally efficient (with fully insulated walls, lofts and A-rated windows), there is less air movement / air changes happening – which results in any moisture being produced becoming trapped within a property.

#### **How is it caused?**

When moisture in the air comes into contact with a cool surface, it condenses into water vapour, appearing as condensation. This moisture content is known as relative humidity (RH).

#### **Internal condensation**

An average family can produce about 18 pints of moisture a day, which disperses into the warm air in our houses. This can be caused by simply drying clothes on radiators, using unvented tumble dryers, boiling a kettle, running a bath, taking a shower, cooking, washing, using gas heaters and even breathing.

The higher the temperature in our houses the more moisture this warm air can hold, if this RH rises too high, mildew will form in all areas of the home.

#### **External condensation**

Condensation can form on the external surface of some double glazed units when the surface temperature of the glass drops below the outdoor dew point temperature.

This is actually a sign that the windows are insulating the property well, and preventing heat from escaping through them – which is good news for heating bills!

#### **How do we prevent it?**

To prevent internal condensation, the amount of moisture within a property must be reduced – ventilation is key. This can be done in many ways: avoid drying clothes on radiators (but if you must, try to confine this to one room, close the door and open a window), use a tumble dryer that has a condenser (if not, ensure that it is fitted with an extraction venting kit to expel the steam outside), ensure that the bathroom door is closed and the window opened when taking a bath or shower.

If condensation is forming in unheated rooms and conservatories, try to provide some form of heating to these areas in cold weather, or keep doors to these areas closed to eliminate the possibility of moisture-laden air entering.

When it isn't practical to open a window or door, a de-humidifier unit will extract the moisture from the air without making the room colder.

## COLOURED PROFILES FOR BESPOKE PROJECTS

Meet the growing demand for coloured profiles with Eurocell  
– offering you a spectrum of possibilities

In addition to the standard colours and foils we offer for our products, Eurocell offers special colours available on extended lead times.

Coloured PVC-U windows are typically used in large multi-storey office blocks, industrial units, hotels, restaurants etc, and are a great alternative to powder coated aluminium. Coloured PVC-U products not only offer a considerable cost saving over aluminium, but are also much more thermally efficient, which in light of the revised building regulations Part L, is now a major factor in which products to choose.

We now offer a Made to Order range, with more than 45 superb colour options. There's everything from the beautiful natural appearance of woodgrain finishes to cool greys, greens and blues.

Made To Order colour lead times have been halved to just three weeks. Any other Renolit foils (excluding Classic) are also available to order on extended lead times.





# PVC-U PROFILES

## TECHNICAL INFORMATION

### SURVEYING AND INSTALLATION

ESSENTIAL WORKING PRACTICES FOR QUALITY INSTALLATIONS

#### Recommendations

The surveying and installation of PVC-U windows and doors are the most important elements of a contract. Incorrectly installed windows have a significant impact on technical performance and customer satisfaction.

As part of the BPF (British Plastics Federation), Eurocell strongly recommends compliance with the Code of Practice for The Survey of PVC-U Windows and Doors sets. Ref 347/1:1995. As well as the Code of Practice for The Installation of PVC-U Windows and Doors Sets. Ref 348/1:1995.

Find out more information at [www.bpf.co.uk](http://www.bpf.co.uk)

These documents cover all aspects of surveying and installing PVC-U windows correctly, including:

- ▶ Preliminary checks when surveying the property
- ▶ Wind loads on window for future design
- ▶ Load bearing windows
- ▶ Bay windows
- ▶ Fire escape windows
- ▶ Preparing openings
- ▶ Fixing methods
- ▶ Use of polyurethane foam for fixing
- ▶ DPC details
- ▶ Glazing and packing
- ▶ Sealing
- ▶ Final inspection checks
- ▶ Cleaning and maintenance

# SECURITY FOR YOUR PEACE OF MIND

## Window security specifications

PAS 24 is the Specification for Enhanced Security Performance of Windows for Domestic Applications.

The specification details the test criteria for manufactured windows to withstand pre-determined forces. British Standard PAS 24 is the basis for the 'Secure By Design' requirement for windows.

All Eurocell window systems have achieved PAS 24 and been awarded Kitemark Licence number KM 52187. Many of the Eurocell nationwide network of window fabricators have also gained this accreditation in their own right. Others (who may not have actually had their window tested) can still manufacture windows to meet this standard by following strict guidelines outlined by Eurocell. In this circumstance, only the hardware used by Eurocell to pass BS7950 may be specified. Plus, fabricators can only claim that they can manufacture windows to meet BS7950 standards and not that they are fully BS7950 accredited.

## Door security specifications

Eurocell has achieved these standards for its doors:

- ▶ PAS 24-1 Enhanced Security Performance Requirements For Door Assemblies
- ▶ PAS 23-1 General Performance Requirements For Door Assemblies
- ▶ Kitemark Licence number KM 500319
- ▶ Secured By Design (subject to specification)



# CASE STUDIES

## EUROCELL PRODUCTS IN ACTION

**Client:** Tauheedul Education Trust

**Project:** Eden Schools, West Midlands

Two new secondary schools in the West Midlands are using the latest Modus windows from Eurocell to achieve a distinctively contemporary appearance, while delivering market-leading thermal performance and a significant cost-saving over aluminium window frames.

Both single-sex schools were constructed as a design-and-build project by Thomas Vale Construction, which employed the Birmingham office of ADP as architects, and adopted Modus after discussions with Eurocell and the fabricator/installer, Leicester-based Unique Window Systems.

These showed that Modus slim-rebate casement windows in an Anthracite Grey (RAL 7016) finish, with a smooth white interior, would achieve the same appearance as more conventional alternatives, with a 25-year design life and ten-year warranty.

The two schools, Eden Girls' School in Coventry and Eden Boys' School in Perry Barr, Birmingham, will be Islamic free schools with 500 secondary places and 200 sixth form places. Both schools were commissioned on behalf of the Tauheedul Education Trust, which runs highly successful non-faith and Muslim faith schools.

According to Glenn Reeves, Project Manager for Thomas Vale, the windows successfully met the project brief: "The frames, glass

and profile are all working well and the installation went smoothly with no delays to our construction programme," he said.

The designs for each school are identical, including £250,000 of frames and fenestration. The 72 frames came in four configurations, but all the window units were unusually tall, measuring 2.4m high.

Featuring a unique 75mm six-chamber profile system, the Modus range delivers the optimum energy efficiency performance and can achieve a U-value as low as 0.7 from a standard system using triple-glazed units.

"We have found Modus to be very successful in taking us into both the educational and commercial sectors. It's a very adaptable profile system and clients like it because it looks great, is more accessible on price than aluminium and offers reduced costs-in-use, because of its superb thermal performance."

**Sunil Patel, Managing Director, Unique Window Systems**







**Client:** British Gas/BRE

**Project:** Smart Home, BRE Innovation Park

BRE Exemplar Project Partner Eurocell and approved fabricator Nationwide Windows have worked with the Building Research Establishment (BRE) and British Gas to refurbish Smart Home in Garston, Watford.

Eurocell windows, composite doors and BBA-Approved Aspect bi-fold doors were specified for the refurbishment as they provide high levels of thermal efficiency, sustainability and value for money.

The refurbished 'House of the Future' showcases the latest products and technologies with the aim of helping households to reduce energy consumption through sustainable refurbishment. Eurocell windows and doors provide greater air tightness than the previous timber windows, as well as improving U values.

Smart Home, formerly the Integer House (which stands for Intelligent and Green), will be used as a reference point by many housing associations, local authorities and architects.

The existing timber casement windows were replaced with casement and tilt & turn versions fabricated and installed by Rugby-based Nationwide Windows, using the Eurocell Eurologik profile system. All new windows incorporated Eurocell PVC-U Thermal Inserts to improve thermal performance and, being

made from 100% post-consumer recycled PVC-U, provide a sustainable method of dealing with end-of-life PVC-U frames from refurbishment projects.

Volunteers are invited to live in the Smart Home for up to two weeks at a time to provide feedback on its energy efficiency, running costs and overall comfort. BRE will work with British Gas, a partner on the project, to use the data from Smart Home to better understand how to apply technology in other homes to make them more efficient and cheaper to run.

“With the changes to the Building Regulations over the last 15 years, improved air tightness for windows and doors has been assisted by advances in frame and glazing technology. Smart Home will highlight how refurbishing existing buildings can be an affordable and a highly effective way of reducing energy bills and improving comfort for residents.”

**John O'Brien, Principal Consultant, BRE**



## CASE STUDIES

### EUROCELL PRODUCTS IN ACTION

**Client:** Wheeldon Homes

**Project:** Hopton Rise, Derbyshire

Derbyshire-based Wheeldon Homes is the latest housebuilder to specify the innovative new Modus window and door profile system from Eurocell.

Modus was specified on 47 properties in the Conservation Area of Middleton, near Wirksworth, a beautiful Derbyshire village. The properties at Hopton Rise feature Modus windows with the flush sash option, in a White Ash woodgrain finish. This offers a genuine alternative to timber windows, without creating an ongoing maintenance burden for homeowners.

Modus frames comprise up-to 50% post-consumer recycled PVC-U, from the dedicated Eurocell recycling facility in nearby Ilkeston. This material is made into the new Modus window profiles at the Eurocell production plant in Alfreton. The fact that the windows are then subsequently fitted in properties in the local area helps Wheeldon Homes achieve an exceptionally low carbon footprint on this development – with a total of just 53 miles travelled.

The post-consumer recycled material is concentrated in the central core of the profiles, where it is completely invisible in the installed window or door.

Complementing the low carbon footprint of these properties is the unique 75mm Modus multi-chamber profile system that locks heat inside the properties to deliver optimum energy efficiency for homebuyers. This innovative design is capable of achieving a U-value as low as 0.7 from a triple glazed window and 1.1 from argon filled double-glazed units.

Being in a conservation area meant that planners had to agree on all external elements of the 47 properties, including the windows. The Modus flush sash was specified because the planning authority felt that the windows offered a genuine alternative to timber, retaining the traditional aesthetic integrity of the village.



“The planners had a clear vision of creating traditional-looking limestone homes and, of course, the windows had to complement this,” said Louise Greenhoff, Quantity Surveyor at Wheeldon Homes. “Timber windows were considered, but we were conscious that these would leave homeowners with maintenance issues in the long-term.”

“The woodgrain finish was approved by the planners, as it works really well with the limestone exterior. The properties have managed to achieve a great balance between contemporary performance and traditional looks.”

“As soon as we presented the Modus flush sash to the planners, they agreed that it was suitable for this development. They liked the fact that Modus retained traditional aesthetics that complemented other properties in the village.”

**Louise Greenhoff, Quantity Surveyor, Wheeldon Homes**



## CASE STUDIES

### EUROCELL PRODUCTS IN ACTION

**Client:** The BRIT School for the Performing Arts & Technology

**Project:** Architectural window replacement

The BRIT School for the Performing Arts & Technology in Croydon, London, is singing the praises of Eurocell window systems after they provided a very exacting architectural window solution.

The school, which was constructed in 1824, is notable for famous students including Adele, Amy Winehouse, Jessie J, Leona Lewis and Katie Melua, among others.

The challenge with BRIT School was to maintain the original aesthetics of the building, which meant a wide variety of window styles had to be manufactured, including vertical sliding sash, arched, half moon, fixed lights, top-hung and specially shaped windows. Eurocell and approved fabricator Dorwin worked together to incorporate unprecedented levels of bespoke features and specifications into the replacement windows, including window frames with white exteriors and black interiors for the staging area of the school.

Adding to the complexity of the project was a requirement for a number of large, elaborate Palladium-style window arrangements to the front of the building. These comprised a large vertical sliding sash window with two narrower sliding sashes each side. The Palladium style was completed with an arched fixed light above and two smaller quadrant windows on each side.

Another challenge was a Building Regulations requirement for half-hour fire rating on all windows to the front East wing of the school. Fabricator Dorwin was able to work with the Eurocell technical team and use its experience and key supply partnerships to present the main contractor with a solution for the client.

**Client:** Etienne Patterson

**Project:** Kole Group Self Build

Etienne Patterson had four principles when he set about building a dream home for himself and a matching home for his parents in rural Hampshire: everything had to be cost effective to install, run and maintain as well as complementing the pastoral setting.

So he chose the innovative Modus system of doors and windows from Eurocell – the UK’s leading manufacturer, distributor and recycler of window, door, conservatory and roofline products – for both houses.

The decision was an important one for the Pattersons, since both two-storey homes are equipped with 49 triple-glazed Modus Casement windows and nine French doors, residential doors and stable doors, all finished in agate grey externally and white woodgrain internally. It is important to Etienne that every element looks as if it is timber but with the unrestricted sightlines of metal and the best-in-class technical performance of PVC-U.

“Everything had to be cost effective to run and maintain – I don’t want to be climbing ladders to paint windows in 10 years’ time – and clearly energy costs have to be low,” Etienne says.

He looked at many different door and window systems before selecting the Modus range, commenting: “This type of house is not intended to have PVC-U, but is meant to be fitted with external doors and windows made of more expensive materials, either all timber, composite or metal.” He added: “Given that we wanted to achieve efficiency both in energy and cost, Modus offered us both, particularly important was the fact Modus doesn’t have the clumsy welds that many PVC-U systems have and has the elegance and simplicity to fit in and enhance the design of the houses.”

The houses – a four-bedroom home for himself and a three-bedroom home for the Patterson parents – are a hybrid of two building methods, oak frame with timber frame encapsulation, with externally a combination of render, brick slips and weatherboarding. The impressive insulation overlaying a skeleton of oak offers a contemporary take on a traditional design.

The slim framed design of Modus casement windows matched the overall aesthetic of the two houses and the opening windows are indistinguishable from the non-opening ones, so the appearance is uniform.

“The casement design means the window can have a floating mullion, so the first floor windows work like a patio door, all four bedrooms have units in a line arranged so that the left-hand or right-hand pair can be opened together to provide a massive escape route,” For Etienne, an Incident Commander in the Fire & Rescue Service, this was an important point because, he says: “It means the bedroom windows provide excellent means of escape but they don’t look any different to the rest of the house.”

Colour was another important consideration as Eurocell could supply all the doors and windows with an agate grey finish on the outside to complement the general ‘heritage’ look made fashionable by paint manufacturers such as Farrow & Ball – and back it with the company’s unique colour match guarantee – while the internal finish is white ash.



# CASE STUDIES

## EUROCELL PRODUCTS IN ACTION

**Client:** Lissett Homes

**Project:** The Warren holiday home development, Gwynedd

Prestige leisure home manufacturer Lissett Homes specified Aspect bi-fold doors from Eurocell for its range of £500,000 luxury sea-front holiday properties at The Warren, Gwynedd in North Wales.

York-based Lissett Homes went further by sourcing a complete one-stop building plastics solution from Eurocell. This involved fabricating windows and contemporary-styled entrance doors using the Eurologik profile system, along with a full range of high-quality building plastics from the Eurocell branch in York.

The Eurocell branch provided a just-in-time (JIT) delivery service to Lissett Homes, enhancing production efficiencies and optimising stock holding. The one-stop-shop building plastics solution from Eurocell enabled Lissett Homes and its client Haulfryn to benefit from a high-quality, perfectly colour-matched product range for all of its deluxe leisure homes.

Lissett Homes specified Aspect bi-fold doors because of their stunning aesthetics, ultra-slim frames and absence of a dummy mullion for the transit door. These features maximise the area of glass so that even when the doors are closed, Lissett customers can enjoy magnificent sea views from a home filled with natural light.

Aspect doors met the demanding quality standards expected by Lissett, which manufactures all elements of its homes, including doors and windows, to control quality at every stage. As well as holding BBA approval, the Aspect bi-fold door system meets PAS24, the British Standard for enhanced security performance of door assemblies, along with PAS23 for general performance and weather tightness. This level of performance will enable Aspect to withstand the sea-front conditions at the site in Gwynedd.

Lissett Homes specified Aspect in White Ash with Satin Silver hardware. Double-glazed Aspect bi-fold doors were specified, achieving a U-value of 1.3Wm<sup>2</sup>/K.

“Aspect fits in perfectly with our brand of luxury holiday homes as it provides high-end aesthetics whilst ensuring that they are energy efficient and maintenance costs are kept to a minimum. These features are key to making our holiday homes an excellent investment that can be enjoyed all year round.”

**Justin Beharrel, Managing Director, Lissett Homes**





**Client:** Morris Homes

**Project:** UK's largest zero-carbon village, Peterborough

Eurocell Eurologik triple-glazed windows and fully recycled cavity closers were specified by Morris Homes for the UK's largest zero-carbon village in Peterborough.

Vista, in the Southbank area of the city, is a development of 295 zero-carbon homes designed to reduce energy emissions by 100% compared to an equivalent-sized standard housing development.

The Eurocell windows achieve a U-value of 0.8W/m<sup>2</sup>K, helping the properties to meet the carbon-reduction requirements of UK Building Regulations up to the 2016 zero-carbon deadline.

Eurologik windows, Cavalok cavity closers and the other energy-saving measures incorporated into the design will contribute to the Vista properties requiring 74% less heating per square foot, compared to the average UK home. Homebuyers will not only feel these benefits in terms of more comfortable and healthier homes, but will delight in the fact that they save around £310 on their annual energy bills.

Morris Homes has demonstrated how sustainable developments, often perceived to be expensive, are now a real alternative for all developers, with two-bedroom properties at the Vista site starting from just £139,000.

The Eurocell Eurologik triple-glazed windows were specified in a grey woodgrain finish to complement the contemporary style of the two and three-bedroom properties. They feature Eurocell 100% post-consumer recycled PVC-U Thermal Inserts, which enable lower U-values and higher Energy Index Ratings to be achieved.

The Cavalok cavity closer system is the UK's only BBA-approved 100% post-consumer recycled PVC-U cavity closer. The range offers a ready-made solution for all levels of the Code

for Sustainable Homes, up to Level 6, zero carbon, and higher levels of BREEAM. The range is suitable for cavities from 50mm to 300mm+ and is available in fire-rated versions.

Mark Starford, Architect at Barnett North, the appointed practice for Vista, said: "The Eurocell window and cavity closer solution is an integral part of helping us reduce energy emissions from these properties by 100% compared to an equivalent-sized standard housing development. We liked the fact that Eurocell was able to offer us a ready-made solution, as well as demonstrating innovative use of post-consumer recycled PVC-U."

Eurocell offers a wide range of specially developed zero and low-carbon window solutions that help housebuilders meet national targets to reduce UK carbon emissions from homes by 29% on 2008 levels ahead of 2020.

Eurocell has developed the largest and most advanced post-consumer PVC-U recycling facility in the UK, which is capable of processing up to 12,000 end-of-life PVC-U window frames per week.

"The Eurocell windows in grey create exactly the right contemporary appeal that homebuyers look for. We like the fact that the slim profile of the frames lets in the maximum amount of natural daylight – and you don't even notice that they have been specified to achieve zero-carbon."

**Cindy Vials, Regional Sales Director, Morris Homes**

# CASE STUDIES

## EUROCELL PRODUCTS IN ACTION

**Client:** Bloor Homes

**Project:** Loddiswell, Devon

Proposing three different colours of Eurologik 70 window from Eurocell – the UK’s leading manufacturer of PVC-U windows – helped Bloor Homes successfully address the concerns of South Hams District Council’s (SHDC) planning department and provide an attractively varied external appearance at its Woolston Fields development.

Set immediately on the outskirts of the small Devon village of Loddiswell, Woolston Fields is a development of 70 homes in a ‘country cottage’ style; including two, three, four and five bedroom properties, in the South Hams – an Area of Outstanding Natural Beauty.

Ideally suited for new build or replacement windows in sensitive areas such as the South Hams, Eurologik provides clean sight lines due to its unobtrusive gasket line and slim profile, while its 70mm front-to-back dimension enables timber frames to be replaced seamlessly.

The three colours selected – Chartwell Green, Cream White, and Moondust Grey – were from the 25+ options available in the Eurocell bespoke foil range and complement the heritage style appropriate to the area, while the windows themselves were fitted with sculpted ovolo beads and Georgian bars that suited the Country Cottage design.

Also available with chamfered beads, the advanced multi-chambered design of the Eurologik system (including optional six-chamber slim outer frame system) and innovative recycled PVC-U thermal inserts work together to lock in heat.

These windows were amongst the first to achieve the ‘A++’ band in England & Wales for Window Energy Ratings (WERs) since the British Fenestration Rating Council (BFRC) launched the new rating in May 2015. The ‘A++’ rating is only given to those windows achieving an energy index value equal to or greater than +20.

“We wanted to mix up the streetscape and provide interesting elevations, rather than just have the monochrome appearance we would have got with plain white frames. The planners were also keen that we should install timber windows but, with Eurologik, we were able to highlight the quality, the look and the finish that we could achieve with PVC-U.”

**Jonathan Pope, Senior Buyer, Bloor Homes.**





# BIM MODELS

Our BIM model library is expanding all the time. It means you're just a couple of clicks away from data rich, 3D objects in the industry's most popular file formats. Speeding up your building designs. Tightening up your costs. Increasing the accuracy of your performance forecasts.

All our BIM Models are available to download at [eurocell.co.uk/bimmodels](http://eurocell.co.uk/bimmodels)

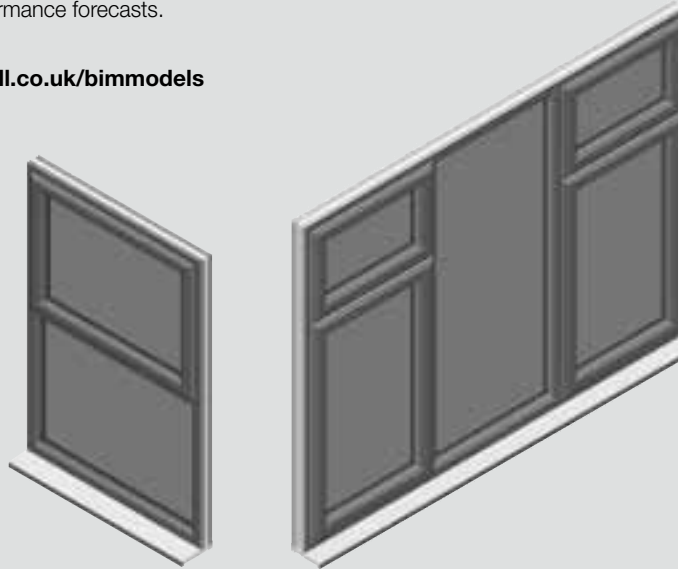

# CPD PRESENTATIONS



## Quality Online and Offline CPD Materials

Earn your CPD points with our RIBA approved windows presentation, available to attend at RIBA and DCE events, or to view on slideshare at [eurocell.co.uk/cpdpres](http://eurocell.co.uk/cpdpres)

Discover more  
visit: [eurocell.co.uk/cpd](http://eurocell.co.uk/cpd)

or call 0800 988 3047 to make  
an appointment for an in-house  
CPD presentation

PVC-U windows

THE PAST  
THE PRESENT  
THE FUTURE

eurocell

CASE STUDY

LIFE BEFORE GREEN DEAL & CLOSER TO ZERO:  
BRE RETHINKING  
HOUSING REFURBISHMENT

£633 SAVED per year on energy bills	75% CO <sub>2</sub> emission reduction	0.9 U-value
--	---	----------------

83  
SAP

TIPS

SPECIFYING RECYCLED PVC-U WINDOWS  
WHAT YOU NEED TO KNOW

Is the external finish extruded or foiled?  
Is it post-extrusion, post fabrication or  
post-consumer recycled material?  
What % post-consumer material content?  
If 100% post-consumer recycled, do  
sashes have untoiled faces?

BUILDING REGULATIONS

WHAT WE EXPECT TO HAPPEN

- VALUE ENGINEERING – COST OF ZERO CARBON
- BEST PRACTICE 2018 – 1.2 U-VALUE WINDOWS
- SOUND ATTENUATION – LAND AVAILABILITY

2016 → 2020

# EUROCELL BRANCHES NATIONWIDE

With more than 150 branches nationwide, Eurocell can provide a local service wherever you are. Find your nearest branch below:

## GREATER LONDON

Bow	020 7511 4850	Enfield	020 8804 9569	Romford	01708 381873
Crayford	01322 553632	Greenford	020 8575 3701		
Dartford	01322 285320	Hayes	020 8569 3363		

## THE NORTH

Accrington	01254 395220	Halifax	01422 344110	Rhyl	COMING SOON
Ashton-under-Lyne	0161 331 9994	Harrogate	01423 879231	Rochdale	01706 654020
Barnsley	01226 770844	Huddersfield	01484 518115	Rotherham	01709 525580
Birkenhead	0151 650 0090	Hull	01482 606611	Scunthorpe	01724 281195
Blackpool	01253 351515	Keighley	01535 600121	Scarborough	01723 586110
Bolton	01204 366272	Kendal	01539 731330	Selby	01757 210200
Bradford	01274 732101	Leeds	0113 238 1387	Sheffield	0114 242 1666
Bradford Collect	01274 722805	Leeds Collect	0113 249 9242	Sheffield Collect	0114 278 0230
Carlisle	01228 513833	Liverpool	0151 933 5353	Skegness	01754 769903
Chester	01244 371700	Manchester	0161 877 8888	Stockport	0161 476 2025
Chesterfield	01246 202968	Middlesbrough	01642 430510	Sunderland	0191 523 5892
Colwyn Bay	01492 540799	Morecambe	01524 843535	Wakefield	01924 298378
Darlington	01325 363686	Newcastle-u-Tyne	0191 270 1280	Warrington	01925 414769
Doncaster	01302 881441	Newcastle West	0191 271 3010	Wigan Collect	01942 825559
Gateshead	0191 491 0850	Oldham	0161 621 0118	York	01904 479201
Grimsby	01472 340177	Preston	01772 701211		

## MIDLANDS

Aldridge	01922 452809	Leamington Spa	01926 432873	Rugby	01788 579184
Alfreton	01773 545810	Leicester	0116 274 2100	Shrewsbury	01743 469897
Birmingham	0121 333 3956	Lincoln	01522 575400	Stafford	01785 215484
Brierley Hill	01384 481263	Mansfield	01623 422800	Stoke	01782 444570
Burton-on-Trent	COMING SOON	Newcastle-u-Lyme	01782 566695	Sutton Coldfield	0121 351 1791
Cannock	01543 462525	Northampton	01604 754833	Tamworth	01827 250630
Coventry	024 7663 7229	Nottingham	0115 985 2522	Telford	01952 292643
Derby	01332 345252	Nuneaton	024 7632 7415	Wolverhampton	01902 424567
Kettering	01536 516159	Peterborough	01733 895137	Worcester	01905 723579
Kings Norton	0121 4596009	Redditch	01527 526500		

## SOUTH & SOUTH EAST

Abingdon	01235 533210	Gloucester	01452 303347	Sittingbourne	01795 420003
Andover	01264 323413	Guildford	01483 563423	Southampton	023 8063 4966
Banbury	01295 271710	Hastings	01424 854414	Southend	01702 616326
Barnstaple	01271 376179	Hedge End	01489 799970	Stevenage	01438 355700
Basildon	01268 273463	Huntingdon	01480 436920	Swindon	01793 878771
Basingstoke	01256 817986	Ipswich	01473 726770	Taunton	01823 325232
Bedford	01234 340825	Kings Lynn	01553 774677	Tewkesbury	01684 276497
Blandford Forum	01258 459367	Luton	01582 562484	Thanet	01843 589686
Bognor Regis	01243 867033	Medway	01634 294300	Thetford	01842 765081
Brighton	01273 674959	Milton Keynes	01908 649501	Trowbridge	01225 765190
Camberley	01276 671901	Newmarket	01638 662692	Wickford	01268 562900
Cambridge	01223 244968	Norwich	01603 789918	Worthing	01903 216967
Chelmsford	01245 357000	Poole	01202 593300	Yeovil	01935 477693
Christchurch	01202 482389	Portsmouth	02392 376290		
Colchester	01206 841796	Reading	0118 986 1930		
Crawley	01293 514425	Redhill	01737 772596		
Folkestone	01303 842223	Salisbury	01722 322327		

## SOUTH WEST & WALES

Avonmouth	0117 982 7053	Cardiff	029 2048 6879	Plymouth	01752 345629
Bangor	01248 355484	Exeter	01392 829721	St Austell	01726 65353
Bridgwater	01278 453166	Newton Abbott	01626 335585	Truro	01872 271356
Bristol	0117 971 3371	Penzance	COMING SOON	Wrexham	01978 312859

## SCOTLAND

Aberdeen	01224 707660	Dundee	01382 835960	Inverness	01463 718488
Aberdeen south	COMING SOON	Edinburgh	0131 657 3196	Livingston	01506 443165
Coatbridge	01236 424287	Glasgow	0141 882 8490		
Dumfries	01387 269982	Irvine	01294 213214		

## REPUBLIC OF IRELAND

Dublin	00 353 1460 5383
--------	------------------

**FOR GENERAL ENQUIRIES,  
FREEPHONE**

**08000 77 88 88**

Find your nearest branch at  
[eurocell.co.uk/branchfinder](http://eurocell.co.uk/branchfinder)



For more information about Eurocell products and services,  
call our customer services team on **0800 988 3047**  
or visit **eurocell.co.uk**

BIM Models available to download at **eurocell.co.uk/bimmodels**

Eurocell plc, Fairbrook House, Clover Nook Road, Alfreton, Derbyshire DE55 4RF



**eurocell.co.uk**