

HOMELINE



Roofline: Specification & Installation

gap 



“Homeline from GAP. The PVC-U roofline range of choice for Britain’s house builders.”



Welcome to Homeline	2-3
GAP	4-5
Guarantees	6
Accreditations	7
Product Overview	8-9
Product Range	10-15
Fascias	10
Soffits	11
Trims	12
Core	14
Installation Requirements	16-17
Installation Diagrams	18
Roofline Ventilation	19
Colour Options	20-21
Product Information	22-23



Welcome to Homeline

Homeline is GAP’s PVC-U cellular building products brand, and sits behind one of the UK’s best-known and most trusted fascia, soffit, trim, dry verge, ventilation and cladding ranges.

It’s produced in our modern 150,000 sqft production plant in Aberdare, South Wales; which is one of the largest in the UK and features a dedicated mixing plant, 12 extrusion lines, 2 foiling lines and a 100 + workforce.

Through our network of 112 Depots we supply BSI and BBA-approved Homeline products to leading players in homebuilding, social housing, and building maintenance.

The range also features Homeline Core - the UK’s only BBA-approved recycled roofline products.

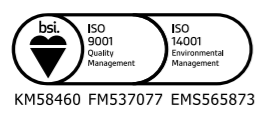



“Gone are the days of trying to manage several different suppliers without a common culture or single point of contact.”



 **Roofline**
Manufacturing

 **Depots**
112 Locations

 **Transport**
Wholly Owned Fleet

 **Local Deliveries**
Nationwide

The Power of One

- One Board of Directors
- One Manufacturer
- One Delivery Fleet
- One Depot Network
- One Account Manager
- One Admin Team
- One Invoice
- One Culture

Vertically Integrated Supply Chain

Guarantees

Homeline Building Products provide a robust guarantee policy that covers all white and foiled cellular products from discolouration, cracking and warping. We also provide guarantees for all rainwater products.



White Profiles – 25 Years

All white PVC-U profiles will retain their decorative (no change greater than grey scale of 3) and mechanical function for a period of 25 years, under natural weathering conditions from the date of installation, provided they are installed and maintained in accordance with the procedures detailed by the BBA.

A 50 year lifetime guarantee for White profiles is available for commercial contractors upon registration and acceptance as a Homeline registered installer.



White Profiles (Core) – 25 Years

All white PVC-U profiles will retain their decorative (no change greater than grey scale of 3) and mechanical function for a period of 25 years, under natural weathering conditions from the date of installation, provided they are installed and maintained in accordance with the procedures detailed by the BBA.

A 50 year lifetime guarantee for White profiles (Core) is available for commercial contractors upon registration and acceptance as a Homeline registered installer.



Foiled Cellular – 10 Years

All foiled (woodgrains and colours) PVC-U profiles will retain their decorative and mechanical function for a period of 10 years, under natural weathering conditions from the date of installation, provided they are installed and maintained in accordance with the procedures detailed by the BBA.



Rainwater Profiles – 10 Years

Rainwater profiles are guarantee against warping, cracking, splitting or discolouration for 10 years*, under natural weathering conditions from date of installation, provided they are installed and maintained in accordance with installation guidelines.

* Please visit www.gap.uk.com/homeline for a full guarantee certificate.

Accreditations

Products and processes within Homeline Building Products have been tested and inspected to ensure they comply with the most stringent product standards available, whilst also conforming to all relevant legislation within the industry.



Accreditations

- BBA 09/4639 (Including Core Recycled Rooflines)
- Manufactured under ISO 9001:2015 Quality Standard System
- Manufactured under ISO 14001:2004 Environmental Standard
- BSI Kitemarked
- BS 7619 Specification Kitemarked
- Fire BS 476 Part 7, 1997
- BS 6105 Compliant
- Members of the BPF (British Plastics Federation)



Product Overview

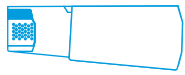

Dry Verge

Dry Verge provides a mortar-free and secure method of fixing concrete interlocking verge tiles. Its neat interlocking design provides a consistent appearance that requires no maintenance.



Fascia Boards

Fascia boards are available in several thicknesses to suit both new builds and refurbishment projects and come in various mouldings and colours to suit building designs and styles.

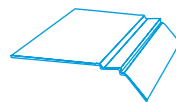

Ventilation

Ventilation is commonly provided through the use of over fascia ventilators which give continuous air flow to the roof space and prevent condensation. Ventilated soffit boards can also be used to provide ventilation to the roof space. See pg 19 for more information.

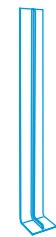

Joints & Corners

A large range of rigid and flexible joints, corners and trims are available to provide a neat finish to all roofline applications.



Rainwater

Available in five different styles to suit rainwater flow rates and six different colours, Homeline's rainwater systems work perfectly with all our fascia boards.

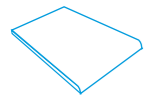

Soffit Boards

Soffit boards are available in solid, pre-ventilated and hollow designs to suit building designs. They provide the return from the fascia board lip back to the brick work and can be used to ventilate the roof space.



Bargeboard

Bargeboard use standard fascia boards as a method of covering the gable end of the roofline.

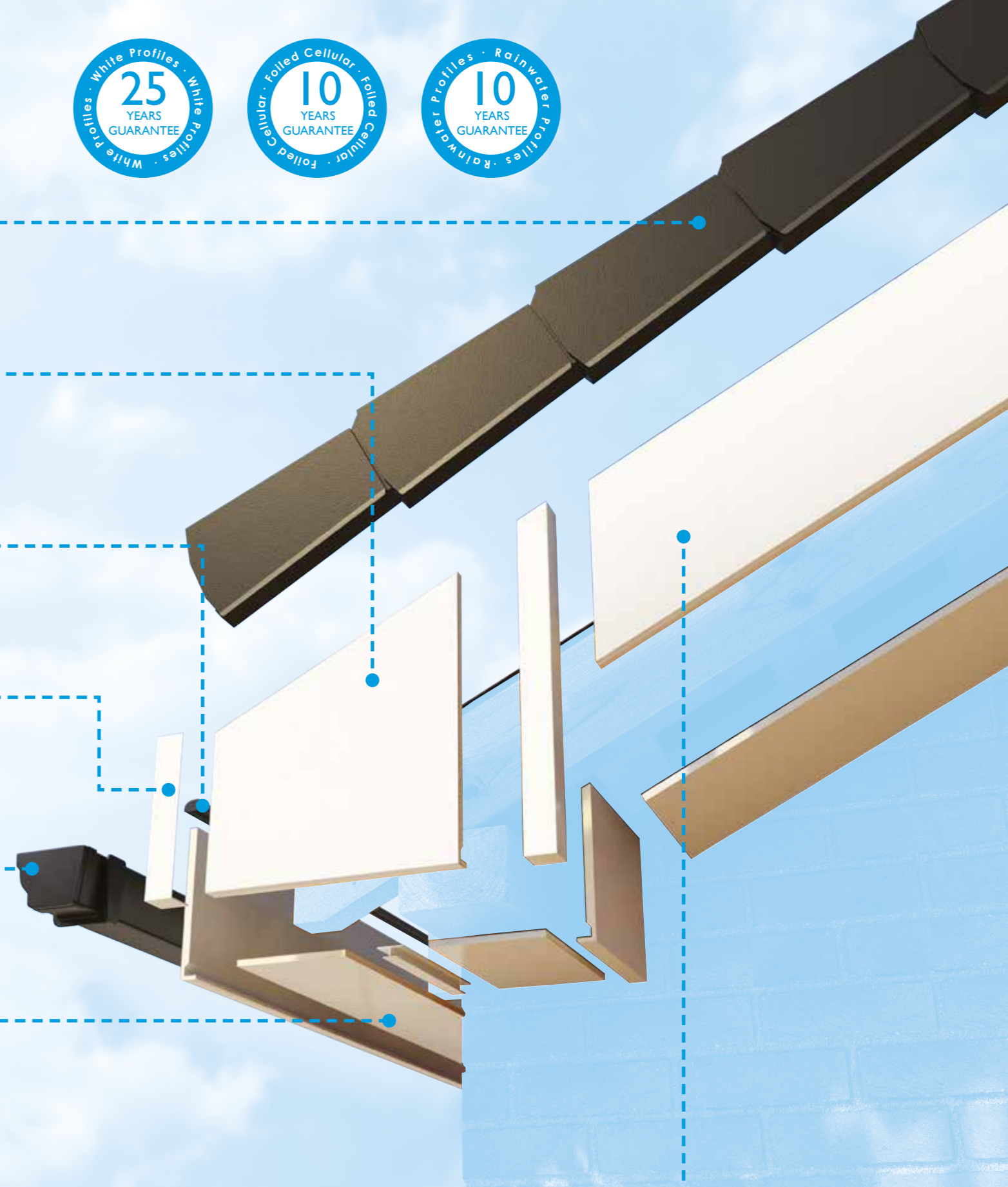

Product Range

A comprehensive selection of fascia boards are available in various styles and thicknesses with different return leg sizes designed to cover the lip of the soffit board. All fascias are available in a range of heights with double ended boards for boxends. Soffit boards are available in solid, pre-ventilated and hollow options in various widths.

Fascia Boards

Square 16mm

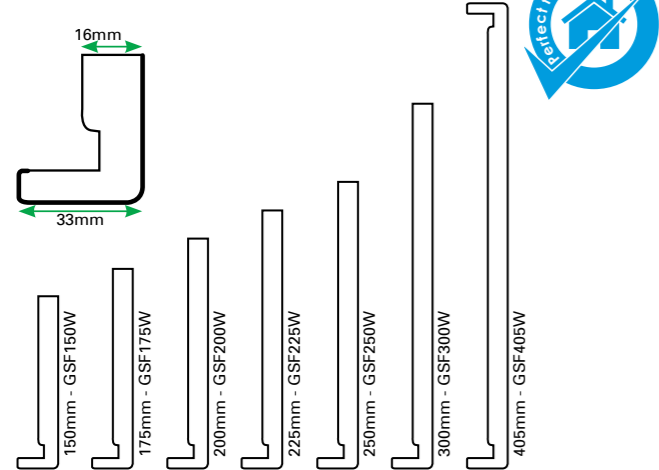

Square 22mm

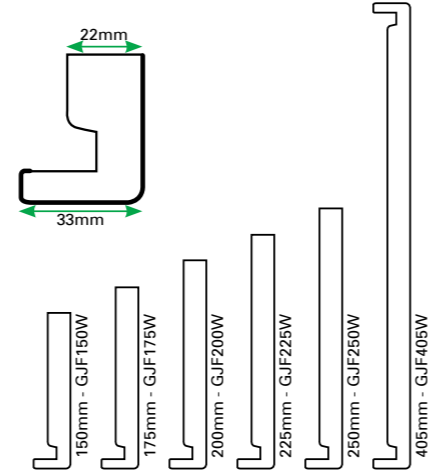

Flat 16mm

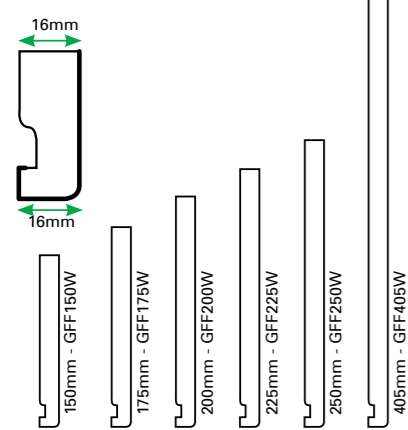

Ogee 16mm

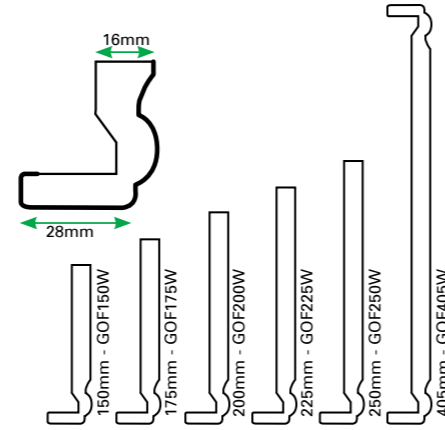

Bullnose 16mm

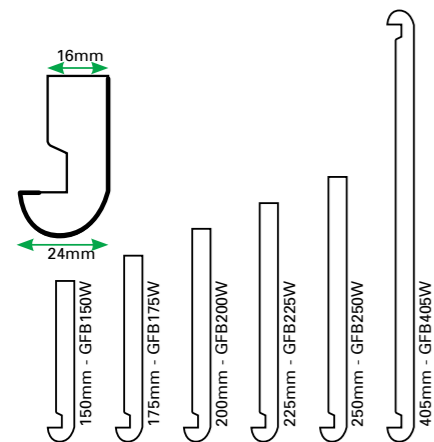

Bullnose 22mm

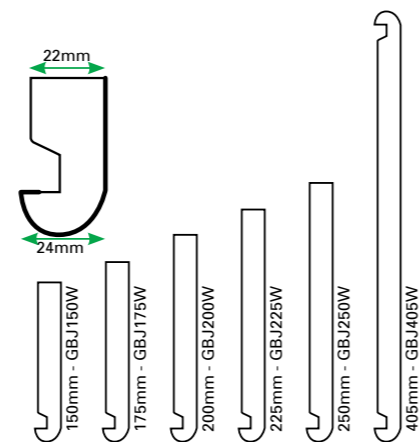

Cap Over Boards

Square Cap Over 9mm

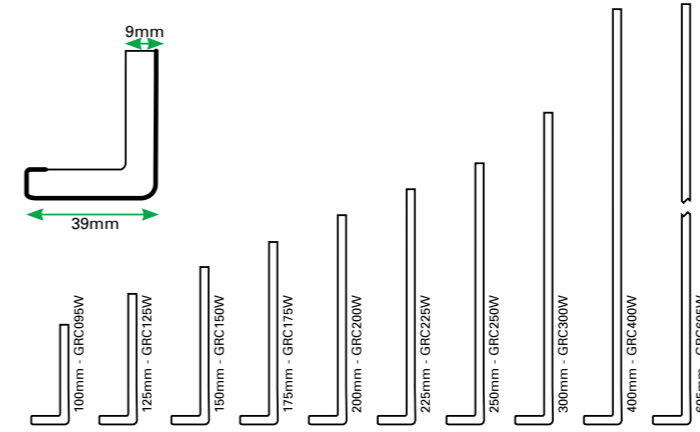

Ogee Cap Over 9mm

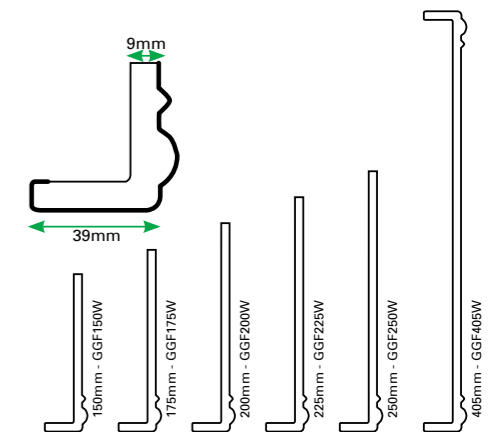

Soffit Boards

Solid Soffit Board 9mm

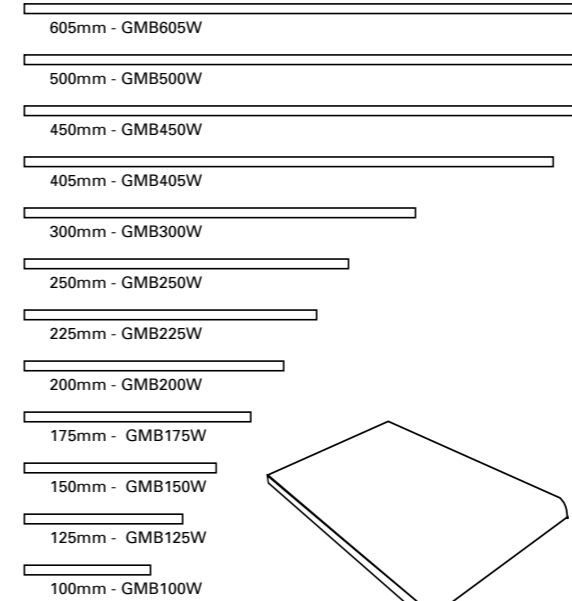

Vented Soffit Board 9mm*

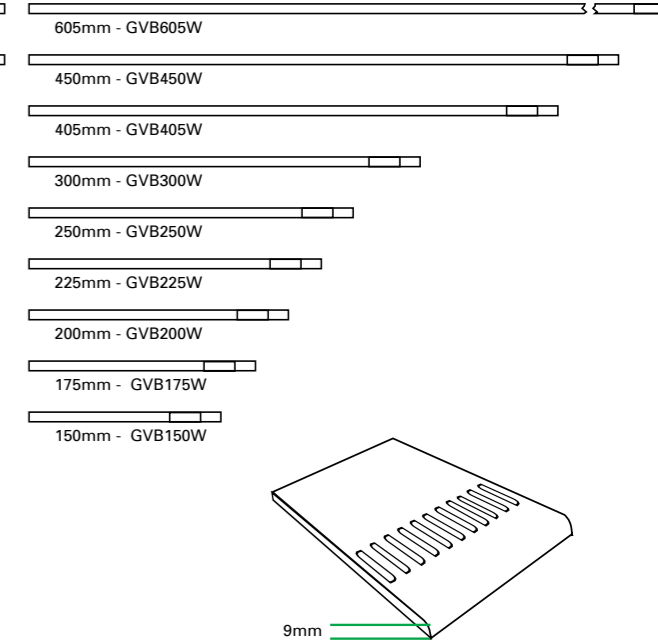

Double Vented Soffit Board 9mm*

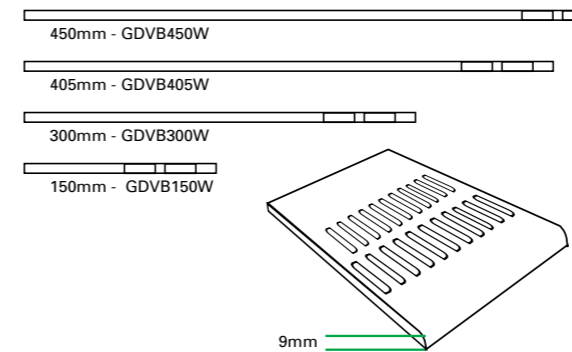

Hollow Soffit

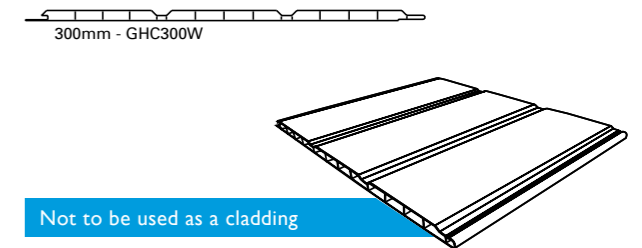

* Please see Ventilation guide at www.gap.uk.com/homeline

Product Range

To provide finishing touches a range of trims, joints and corners are available for roofline installations. Ventilation options are provided through over fascia ventilators or circular vents for the soffit.

Finishing Touches

Decorative Fascias Convex 16mm

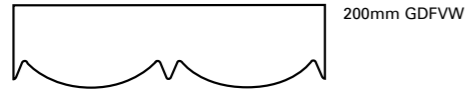

3D Spire

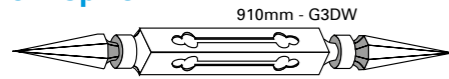

Flat Back Spire

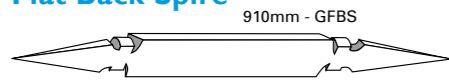

Decorative Fascias Concave 16mm



Ball End Finial

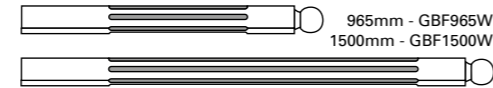

Bracing Bar

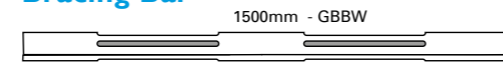

Gable Finial

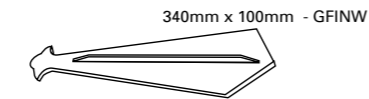

Joints

Single Ended Corners

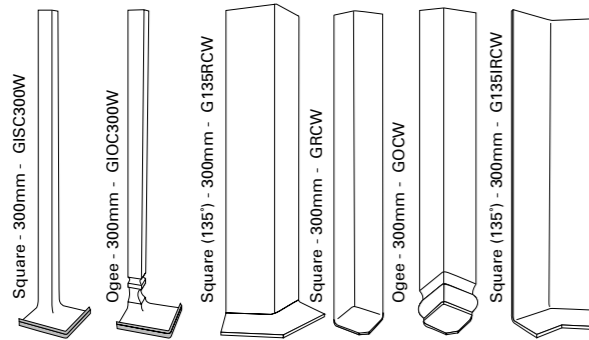

Single Ended Joints

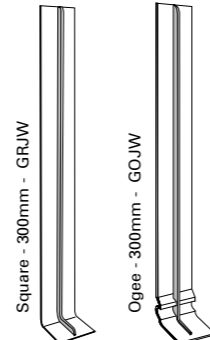

Double Ended Corners

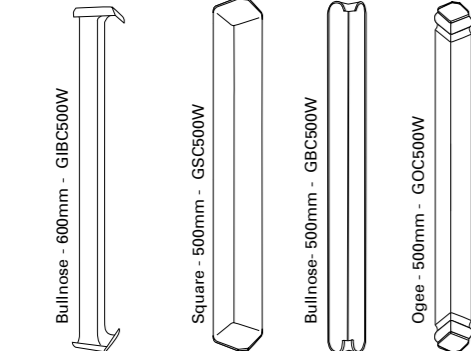

Double Ended Joints

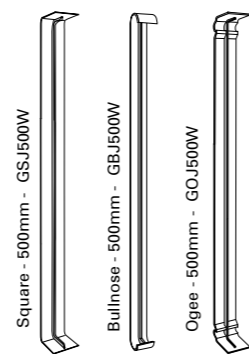

Trims

Soffit Joint Trim

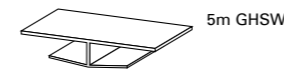

Centre Joint Trim

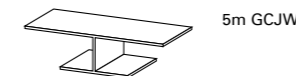

J Trim

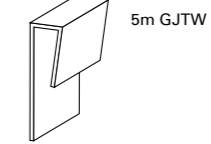

2 Part Universal Trim

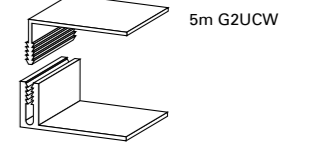

2 Part External Corner

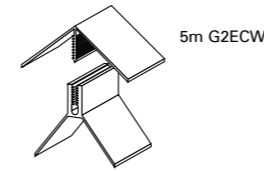

U Channel

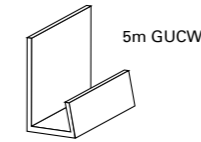

Felt Roof Edge Trim

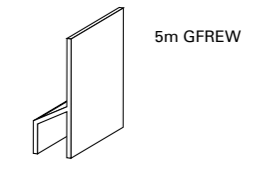

Ventilation

Over Fascia Protection

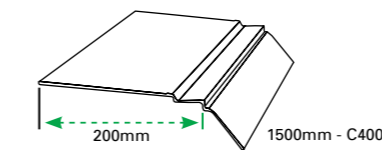

Combed Vent

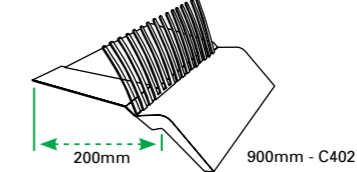

Jumbo Vent

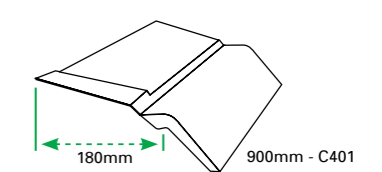

Circular Vent

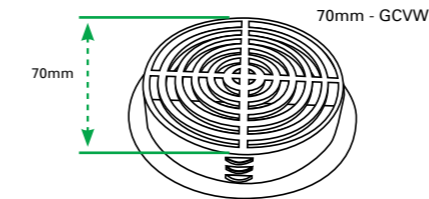

Over Fascia Ventilator

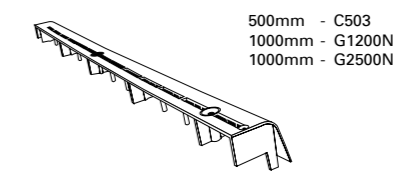

Please see Ventilation guide at www.gap.uk.com/homeline



HOMELINE

“The complete solution for PVC-U rooflines.”

Product Range

Core is Homeline's exclusive range of BBA-approved rooflines. Included in the range are full replacement fascia boards, soffit boards and a cap over board.



Fascia Board

Square 16mm

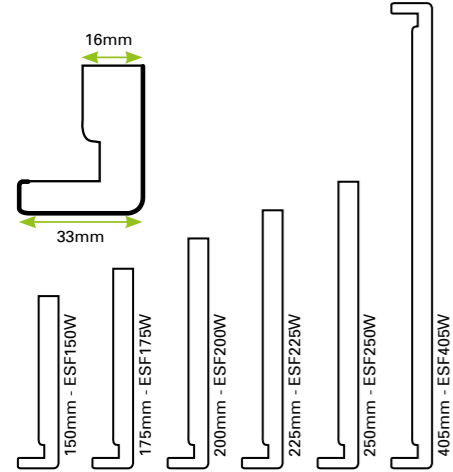

Cap Over Board

Square Cap Over 9mm

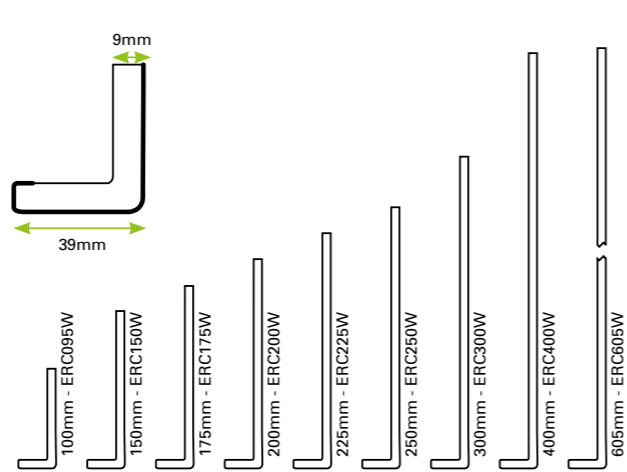

Soffit Board

Solid Soffit Board 9mm

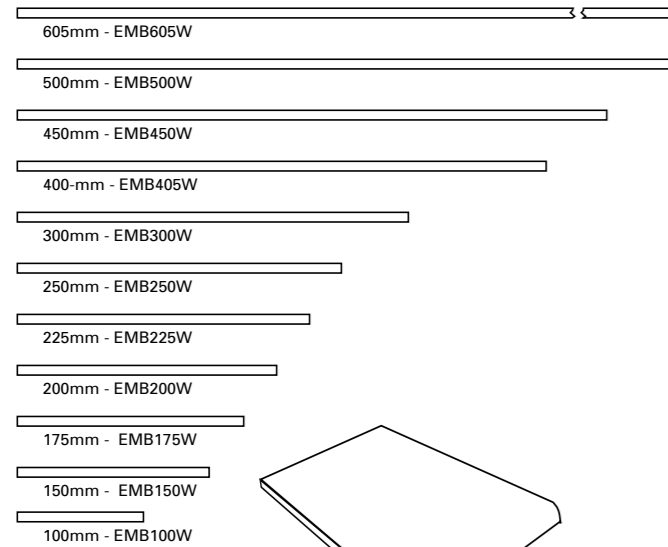

Virgin PVC-U Outer Skin

To ensure colour stability and exact colour matching, we use the same process as our standard fascias for the outer skin of the roofline system. This means once installed – it's impossible to tell the difference between a standard and recycled roofline.

100% Recycled Inner Core

We use recycled foam products which are processed and then pulverised into pellets to ensure they can be re-extruded into our inner core. The difference in colour is a natural occurrence based on different coloured foams being recycled. Don't forget that once installed you can't see the inner core.

Whether you're a House Builder or Specifier, using BBA-approved Core rooflines will demonstrate you're committed to using top quality recycled materials on your development, from one of the most forward thinking and environmentally friendly roofline manufacturers.



Installation Requirements

- Selected boards and accessories are assembled and cut to size.
- Rafter feet are cut to a line.
- Soffit bearers, battens, eaves fillets, brackets and other additional timber supports are fixed to a sound substrate.
- Remove protective film before or straight after installation.



Fascia Boards

- Full replacement fascia boards are fixed directly to rafter ends at centres not exceeding 600mm for white and 400mm for foiled profiles, using 2 x 65mm A4 marine grade stainless steel plastic headed nails.
- Cap over fascias should be fixed as above, as well as using a backing board of marine grade plywood of not less than 12mm thick.
- Butt joints between fascia boards should be made at the rafter end and covered with fascia joint, fixed to the end of one board with either a low-modulus silicone sealant or a solvent-weld adhesive. Provision for expansion (minimum 10mm in-between two 5m boards) should be allowed between boards.
- At corners the joint is covered with a corner trim, fixed to the end of one board only with a plastic headed pin, solvent-weld adhesive or low-modulus silicone sealant. Provision for thermal movement of the boards should be allowed as above.
- PVC-U gutter systems as specified to BS4576-1:1989 may be screw-fixed directly to full replacement fascia boards. Gutter bracket spacing must not exceed 1m and are typically at a maximum no greater than 800mm centres.



Soffit Boards

- Soffit boards are cut to size and fitted into the groove at the rear of the fascia.
- The boards are fixed to rafter feet, soffit bearers or other timber support at centres along their length, not exceeding 600mm for white and 400mm for foiled profiles, and across their width, not exceeding 200mm, using 2 x 40mm A4 marine grade stainless steel plastic headed pins.
- Where required, soffit boards may be joined along their length or width leaving a 4mm expansion gap at each board end using a soffit joint strip.
- To comply with building regulations, a vented soffit board, soffit ventilator or over fascia ventilation should be used as required.

Bargeboards

- Bargeboards are installed by fixing fascia boards to a gable ladder.
- Bargeboards meeting at a ridge should be mitred to the appropriate angle. A fascia joint or finial should be used to cover the joint.
- Box ends are constructed from a larger depth fascia board and trimmed to suit the roof pitch.

Square Fascia & Soffit

16mm square fascia boards should be nailed directly to rafter ends with ventilation provided through over fascia ventilators. The gap between the fascia and the brick should be closed using a 9mm soffit board.

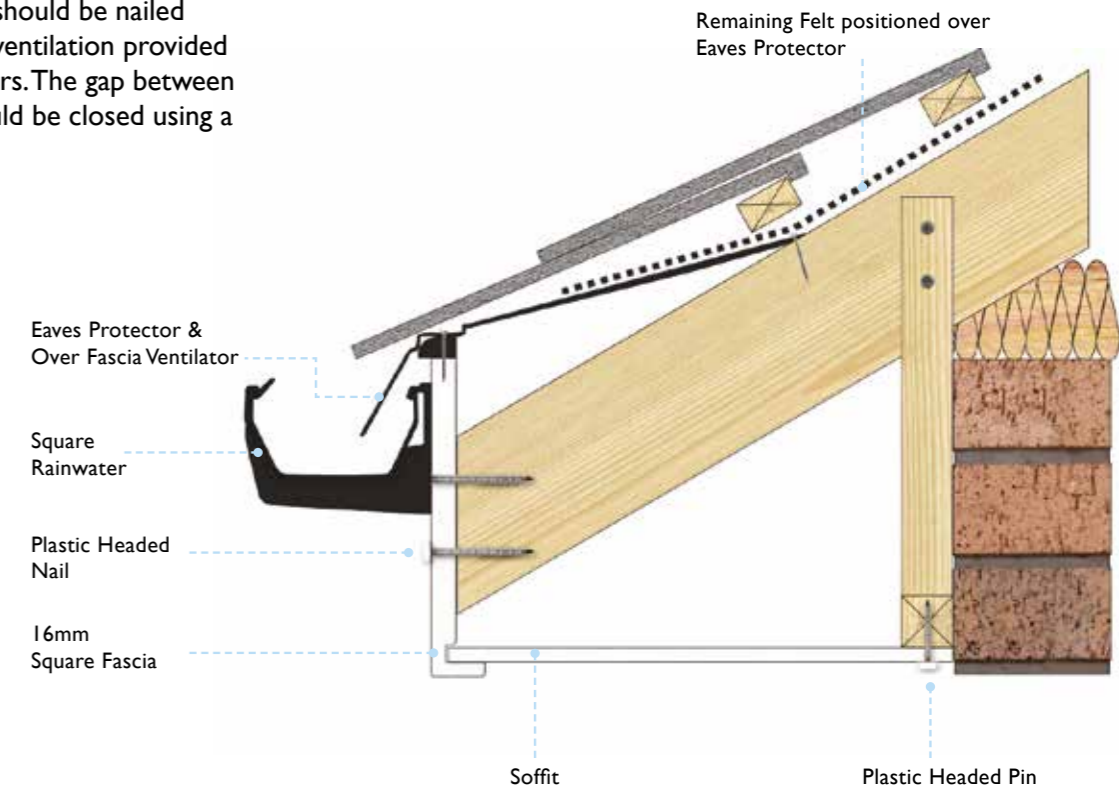

Bargeboard & Soffit

16mm square fascia boards should be used to protect the bargeboard on the gable end of the roof with interlocking or continuous dry verge being used to protect the verge. The gap between the fascia and the brick should be closed using a 9mm soffit board.

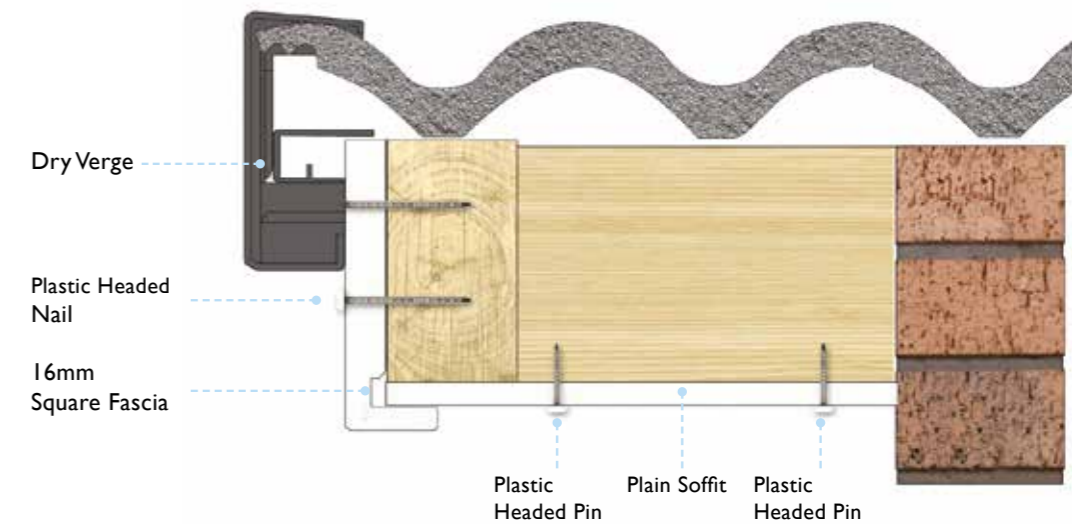

Installation Diagrams

Fascia Joints

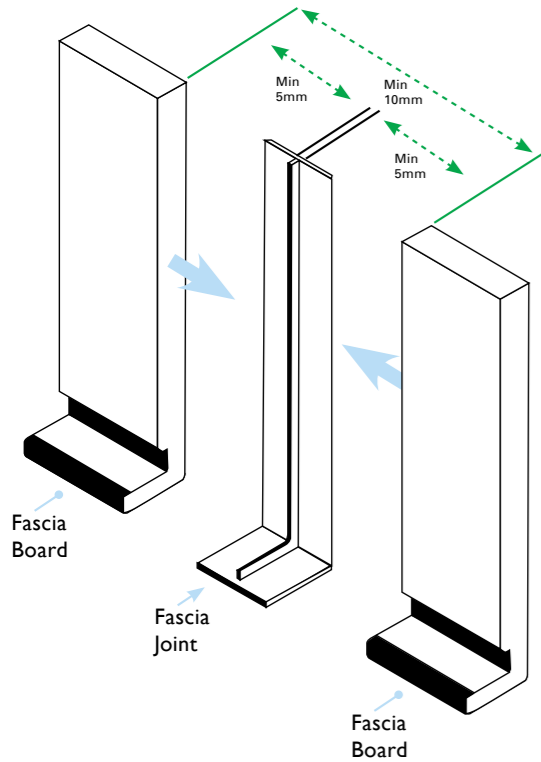

Soffit Joints

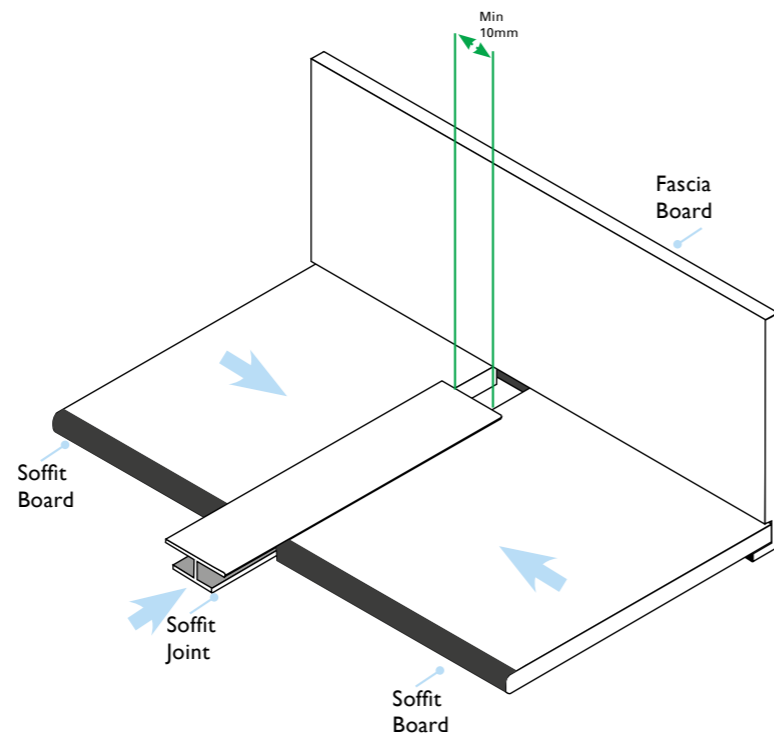

External Corner

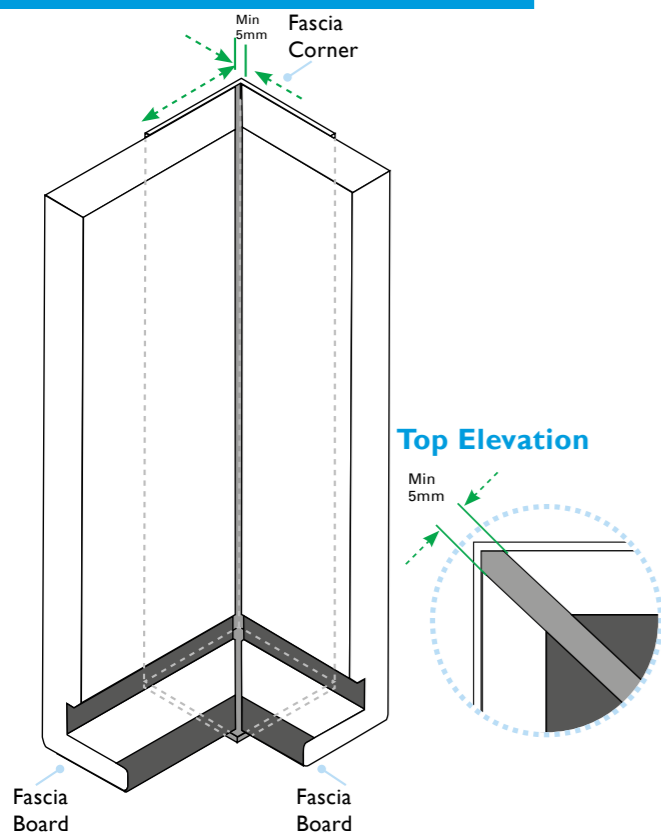

Internal Corner

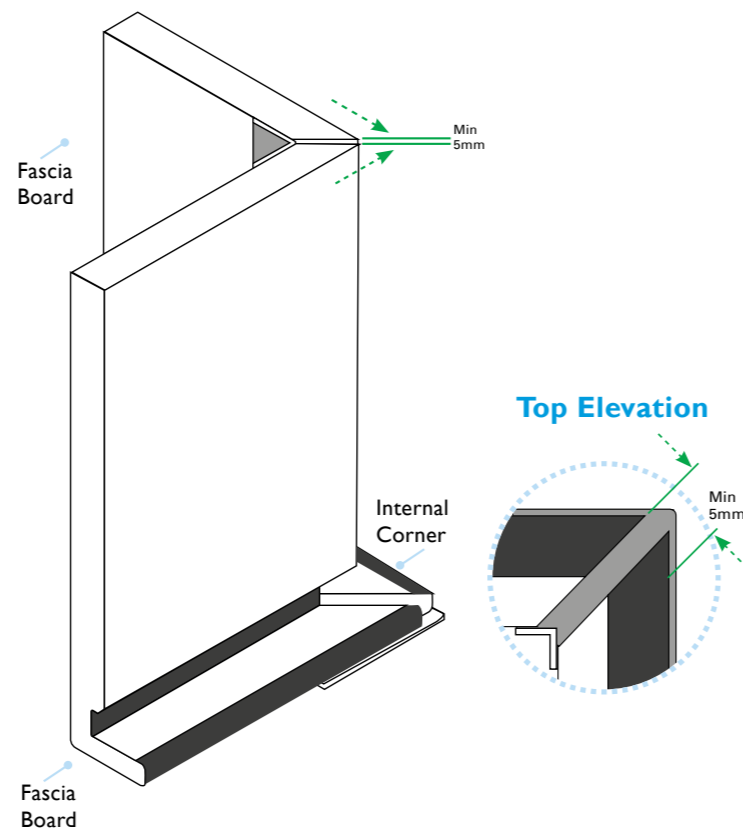

Roofline Ventilation

Homeline vented soffit boards are covered by the BBA certificate 09/4639. When used in accordance with this certificate they provide a simple and effect method for meeting building regulations.



Pitch Over 15

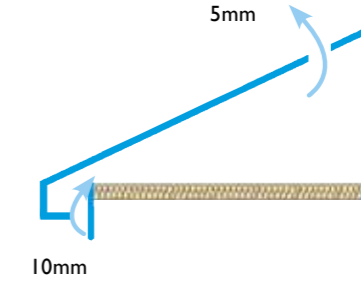
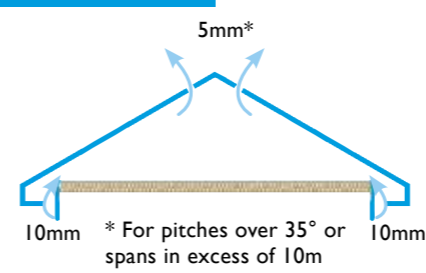

Pitch Under 15°

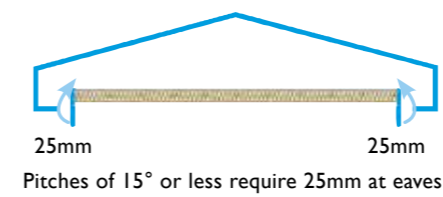

Warm Roofs

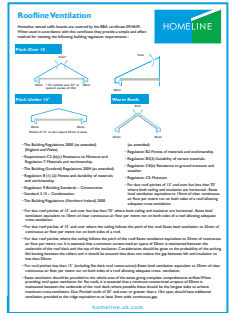
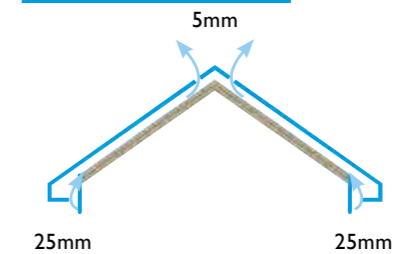

Roofline Ventilation guide is available on our website.

Single vented boards offer a 14mm continuous slot or 14,000 square mm pre linear metre, with double vented boards offering a 28mm continuous slot or 28,000 square mm pre linear metre.

For more information relating to ventilation, please visit www.gap.uk.com/homeline

Fascia Fixing Points

Homeline fascia boards are easy to install thanks to horizontal lines on the protective film. This ensures the plastic headed nails are perfectly level and spaced accurately along the board at either 600mm (white) or 400mm (foils) centres.

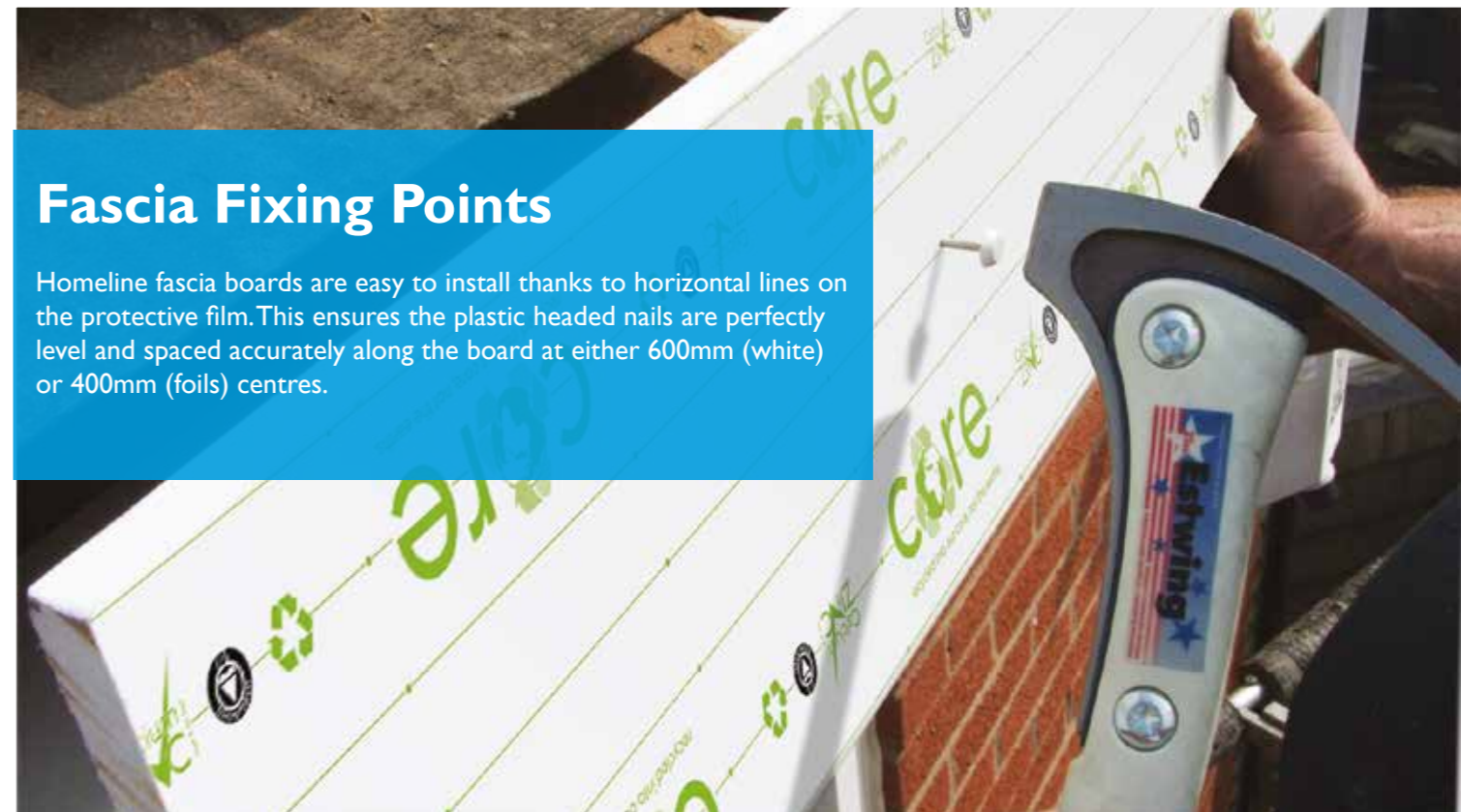



G Grained

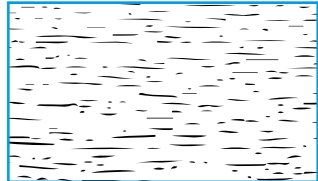

A woodgrain embossed finish which matches PVC-U window and door profiles.

S Smooth



A smooth finish to replicate the appearance of Aluminium profiles.

Colour Options

Homeline rooflines are available in several colour and finish options (smooth and grained) as shown above. For exact colour options, please ask your representative for a colour swatch.



For Appearance, Durability and Colourfastness please see page 22.



Heat Shield Protection

Exclusive to Homeline, Heat Shield is a revolutionary technology that prevents coloured or woodgrain foils from warping, bending, cracking or bubbling.



- Reflects 80% of the sun's harmful rays
- 12 times thicker than traditional foils
- 250 microns thick
- Difficult to scratch due to thickness of foil

Product Information



Appearance

Products are free from sink marks, cracks or foreign bodies when viewed at 90° to the surface at a distance of 1m in diffused north light.



Density

The density of Homeline Cellular PVC-U is on average 500 kg/m.



Durability

Products will retain their physical integrity for many years. Visually they will age uniformly with only minimum changes to appearance. White and foiled products carry comprehensive guarantees (please see pg. 6 for more details). Hollow Soffit must not be used as a cladding.



Colourfastness

All our products have passed the U.V. aged impact tests and the colourfast requirements set out in BS7619. All white products will not change greater than a Grey scale of 3 when exposed to normal weather conditions experienced in northern Europe.



Chemical Resistance

In order to preserve the high quality surface finish it is recommended that only warm soapy water is used to clean the product as required.



Fire Classification

When tested in accordance with BS476-7 : 1997, full replacement fascia boards achieve a Class 1 surface spread of flame rating. Soffit and the hollow soffit achieve a Class 1Y rating.



Impact Resistance

All Homeline products are certified by BS7619 for impact tests.



Softening Point

Homeline cellular products have a softening point in the region of 70°C.



Heat Shield

Standard on all Homeline foils, Heat Shield technology prevents heat from being absorbed into the profile preventing warping, bending and twisting.



Water Absorption

Tests have been carried out to BS EN ISO 62 1999 and typically Homeline cellular products have a water retention of < 1%.

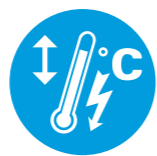

Thermal Movement & Conductivity

The co-efficient of linear expansion for our white products at 20°C is 5×10^{-5} as tested in accordance with BS4370-3 1998. For 9mm thick fascia profiles it is recommended that a 5mm expansion gap is given to both ends of the board. For foiled products it is recommended that an 8mm expansion gap is used both ends of the product. Homeline Building Products have been tested in accordance with BS4370-2 1993 resulting in a value of 0.062W/mK which is greater than the equivalent soft wood product.



Loading

Full replacement fascia boards will support eaves tiles in common usage, provided they are installed in accordance with manufacturer's guidelines.

Product Information

Homeline Building Products are manufactured and tested to BS7619 and our manufacturing facility has been accredited to ISO 9001:2015 and 14001:2004.



Handling & Storage

PVC-U cellular products are relatively light and easy to handle due to their composition. Therefore, when handling our products all you need to do is ensure both ends of the profile are supported to prevent the product being damaged.

It is advisable that products are stored under cover, with the face against a flat firm surface. If stacked (i.e. not in a steel stillage), do not exceed 1m in height. Cellular products are protected using polythene lo-tac film with fixing points on fascia boards.

Distribution

Products are delivered to site or storage facilities using GAP's own dedicated delivery fleet from 112 depot locations strategically located across the UK.

Environmental Information

Homeline Building Products takes its impact on the environment seriously. We are committed to providing quality products and services which comply with all relevant environmental legislation and we strive to use pollution prevention and environmental best practices in all aspects of our operation.

- 100% recyclable
- Can be recycled up to 10 times
- More thermally efficient than timber
- Weather resistant
- Working life of over 40 years
- Never needs painting
- Recycled roofline option available

Working with Materials

PVC-U by its very nature is virtually maintenance free. Once installed, we recommend the products are cleaned using soapy water to remove any dirt or dust that has gathered. Cutting and shaping of PVC-U is quite easy and existing carpentry tools may be utilised. It is recommended that the protective tape is removed either immediately before or straight after fitting, as exposure to sunlight can make the tape very difficult to remove.

Health & Safety

When cutting or shaping materials, ensure adequate protection is taken to avoid any injury. Protective eye and hand equipment should be worn. COSHH sheets available on request





GAP Ltd
Partnership Way
Shadsworth Business Park
Blackburn
BB1 2QP

T: 0845 313 10 12
F: 0845 313 03 13
W: gap.uk.com
S: @GAPLtd

General All-Purpose Plastics Ltd, T/A GAP Ltd
Registered No: 02767596

All photographs, colours and images are to be considered as representative of the actual product. Homeline reserve the right to change colours, sizes or designs without prior notice.

Homeline is a registered trade mark © 2377290. GHBP-PG-05-11/17.

gap.uk.com