

Ecophon Solo™ Rectangle

Solo Rectangle is a free hanging unit, offering high level design possibilities. Three different suspension systems offer opportunities to create several layers and angles. Suitable when the room volume should be maintained or when it's not possible to install a wall-to-wall ceiling.



M30 Achterden, Oisterwijk, Netherlands

SYSTEM RANGE

	Size, mm	1200x600	1800x1200	2400x600	2400x1200	3000x1200
	Special Fixing	•	•	•	•	•
	Thickness	40	40	40	40	40
	Inst. Diagr.	M637	M404, M506	M405	M406, M407, M506	M408

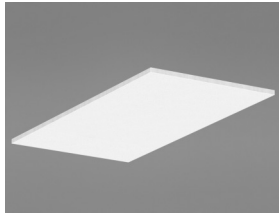

Solo Rectangle

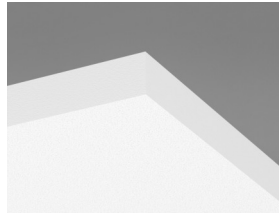

Solo panel

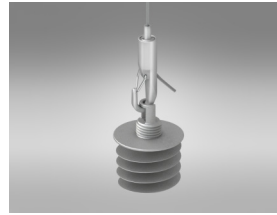

Suspension with Connect Adjustable wire hanger and Connect Absorber anchor



Suspension with Connect Adjustable wire hanger and Connect Absorber anchor

Acoustic



The values in the diagram refer to a single unit. If the units are arranged in a cluster with distances between units less than 0,5 meters, the Aeq per unit will be slightly reduced.

Sound Absorption:

Test results according to EN ISO 354.

A_{eq}, Equivalent absorption area per unit (m² sabin)

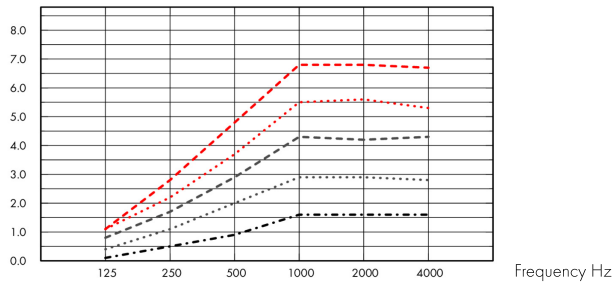

- Solo Rectangle 2400x1200, 1000 mm o.d.s.
 - Solo Rectangle 1800x1200, 1000 mm o.d.s.
 - Solo Rectangle 2400x600, 1000 mm o.d.s.
 - Solo Rectangle 3000x1200, 1000 mm o.d.s.
 - Solo Rectangle 1200x600, 1000 mm o.d.s.
- o.d.s = overall depth of system

	THK mm	o.d.s. mm	A _{eq} , Equivalent absorption area per unit (m ² sabin)					
			125 Hz	250 Hz	500 Hz	1000 Hz	2000 Hz	4000 Hz
2400x1200	40	200	1.3	2.8	3.5	4.1	4.1	3.9
2400x1200	40	400	1.2	2.4	3.3	4.7	4.9	4.7
2400x1200	40	1000	1.1	2.2	3.7	5.5	5.6	5.3
1800x1200	40	200	0.6	2.0	2.9	3.4	3.3	3.1
1800x1200	40	400	0.8	1.9	2.6	3.7	3.7	3.6
1800x1200	40	1000	0.8	1.7	2.9	4.3	4.2	4.3
2400x600	40	200	0.5	1.4	2.0	2.4	2.3	2.3
2400x600	40	400	0.4	1.2	1.8	2.6	2.7	2.7
2400x600	40	1000	0.4	1.1	2.0	2.9	2.9	2.8
3000x1200	40	200	1.1	3.3	4.4	5.1	5.1	5.0
3000x1200	40	400	1.2	3.0	4.2	5.8	5.8	5.7
3000x1200	40	1000	1.1	2.8	4.8	6.8	6.8	6.7
1200x600	40	200	0.1	0.7	1.0	1.3	1.3	1.4
1200x600	40	400	0.2	0.5	0.9	1.4	1.5	1.6
1200x600	40	1000	0.1	0.5	0.9	1.6	1.6	1.6

Indoor Air Quality



Certificate / Label	Standard	Plant
Eurofins Indoor Air Comfort®	IAC	IAC Gold
French VOC	A	A+
Finnish M1	•	•





Cradle to Cradle Certified®



This product is Cradle to Cradle Certified® at Bronze level (version 4.0).



Material Health

This product has received a C2C Certified Material Health Certificate™ at the Silver level (standard version 4.0). The C2C Certified Material Health Certificate™ is a verification of the health and safety of a product's composition using the Material Health requirements of the Cradle-to-Cradle Certified Product Standard.



Environmental Footprint

	kg CO ₂ equiv/m ²	Life-cycle stages A1 to C4 from EPD, in conformity with ISO 14025 / EN 15804
Solo Rectangle	9,12	
Solo Rectangle/Plant	5,32	



Circularity

Minimum post-consumer recycled content	57%
Recyclability	Fully recyclable



Fire safety

Country	Class	
Europe	EN 13501-1	A2-s1,d0

The glass wool core of the tiles is tested and classified as non-combustible according to EN ISO 1182.



Humidity Resistance

Product	According to EN 13964:2014	
Standard	Class C, RH 95% and 30°C	
Plant	Class A, RH 70% and 25°C	



Visual appearance

White Frost, nearest NCS colour sample S 0500-N, 85% light reflectance. Gloss < 1.



Cleanability

Daily dusting and vacuum cleaning. Weekly wet wiping.



Accessibility

The tiles are demountable.



Installation

Installed according to installation diagrams, installation guides and drawing aid. For information regarding minimum overall depth of system see quantity specification.



System weight

Approximately 6,5-17,5 kg.



Mechanical properties

The tile can take both point loads and distributed loads. See Functional demands, Mechanical properties at www.ecophon.com.



CE

Ecophon ceiling systems are CE marked according to the European harmonized standard EN13964:2014. CE marked construction products are covered by a Declaration of Performance (DOP) which enables customers and users to easily compare performance of products available on the European market.

INSTALLATION DIAGRAM (M404) FOR ECOPHON SOLO RECTANGLE 1800X1200

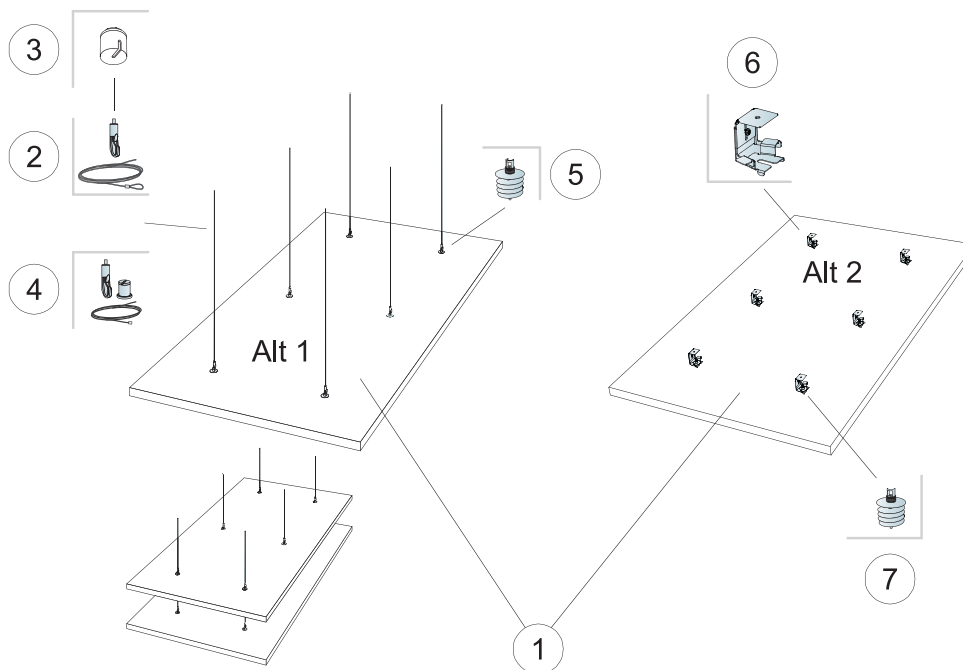

QUANTITY SPECIFICATION (EXCL. WASTAGE)

		Size, mm
		1800x1200
1	Solo Rectangle	2,16m ² /panel
2	Connect Adjustable wire hanger (Alt 1)	6/panel
3	Connect Covering cup (Alt 1, Optional)	6/panel
4	Connect Adjustable wire kit (Alt 1, Optional)	6/panel
5	Connect Absorber anchor (Alt 1)	6/panel
6	Connect Absorber bracket (Alt 2)	6/panel
7	Connect Absorber anchor (Alt 2)	6/panel
Δ Min. overall depth of system: Δ1 140 mm / Δ2 90 mm		-

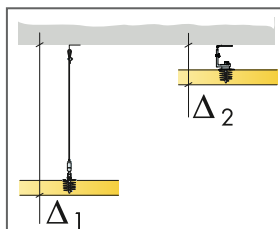

See Quantity specification

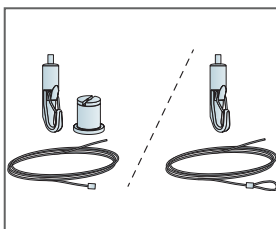

Two types of Adjustable wire solutions

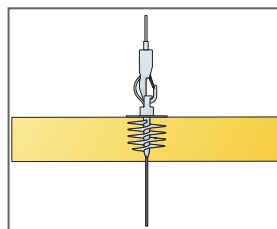

Panels can be suspended underneath each other

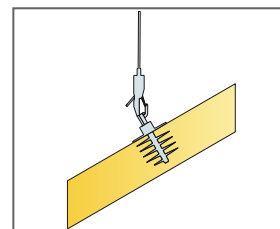

Panels can be installed in angles

INSTALLATION DIAGRAM (M405) FOR ECOPHON SOLO RECTANGLE 2400X600

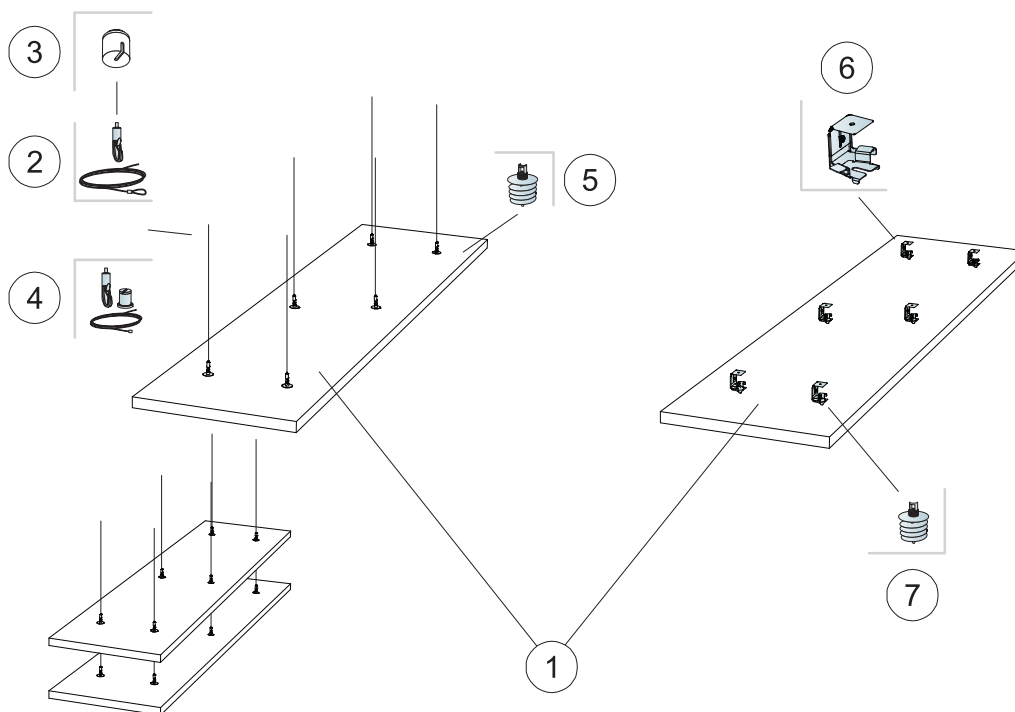

QUANTITY SPECIFICATION (EXCL. WASTAGE)

		Size, mm
		2400x600
1	Solo Rectangle	1,44m ² /panel
2	Connect Adjustable wire hanger (Alt 1)	6/panel
3	Connect Covering cup (Alt 1, Optional)	6/panel
4	Connect Adjustable wire kit (Alt 1, Optional)	6/panel
5	Connect Absorber anchor (Alt 1)	6/panel
6	Connect Absorber bracket (Alt 2)	6/panel
7	Connect Absorber anchor (Alt 2)	6/panel
Δ Min. overall depth of system: Δ1 140 mm / Δ2 90 mm		-

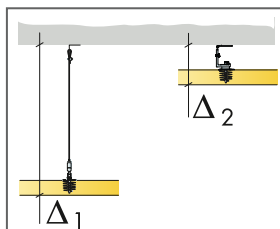

See Quantity specification

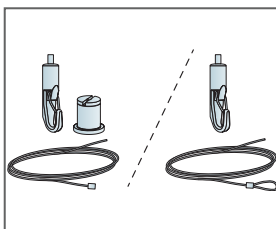

Two types of Adjustable wire solutions

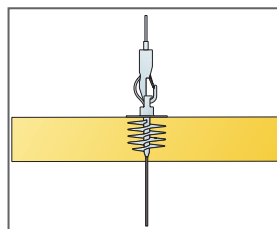

Panels can be suspended underneath each other

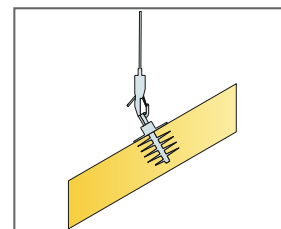

Panels can be installed in angles

INSTALLATION DIAGRAM (M406) FOR ECOPHON SOLO RECTANGLE 2400X1200

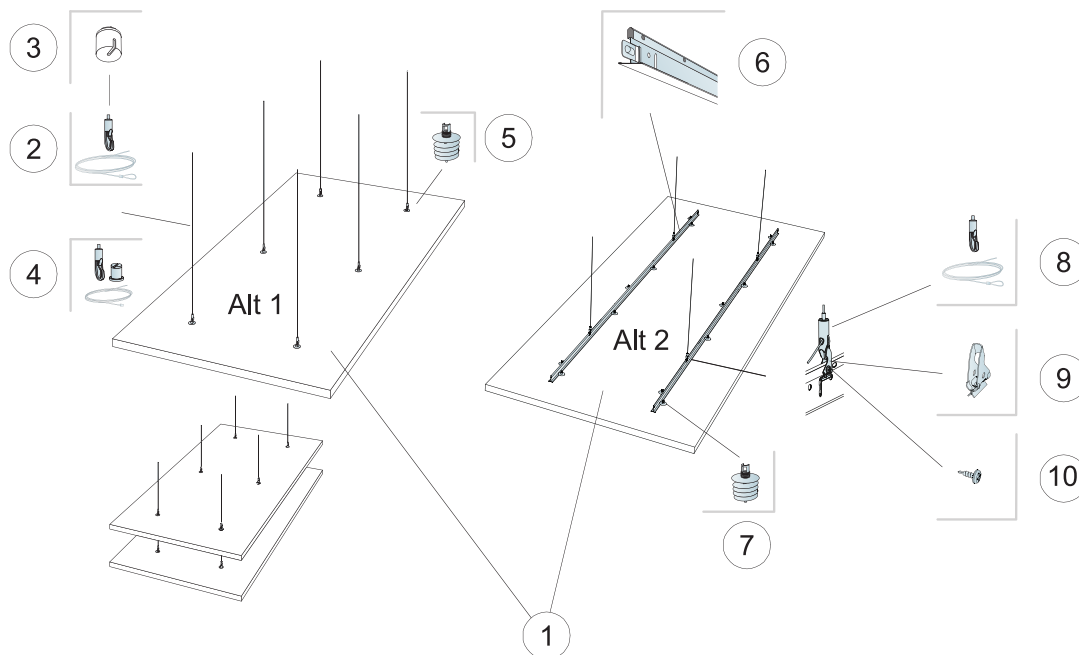

QUANTITY SPECIFICATION (EXCL. WASTAGE)

		Size, mm
		2400x1200
1	Solo Rectangle	2,88m ² /panel
2	Connect Adjustable wire hanger (Alt 1)	6/panel
3	Connect Covering cup (Alt 1, Optional)	6/panel
4	Connect Adjustable wire kit (Alt 1, Optional)	6/panel
5	Connect Absorber anchor (Alt 1)	6/panel
6	Connect T24 Main runner C3	2/panel
7	Connect Absorber anchor	14/panel
8	Connect Adjustable wire hanger	4/panel
9	Connect Adjustable wire hanger	4/panel
10	Connect Installation screw BR	4/panel
Δ Min. overall depth of system: Δ1 140 mm / Δ2 200 mm		-

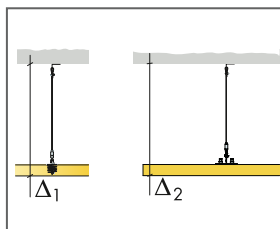

See Quantity specification

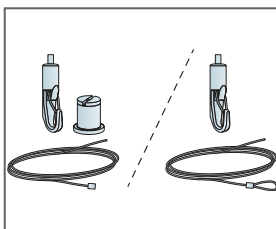

Two types of Adjustable wire solutions

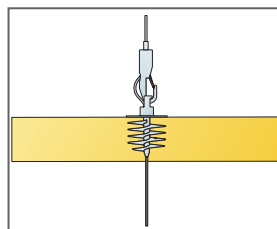

Panels can be suspended underneath each other

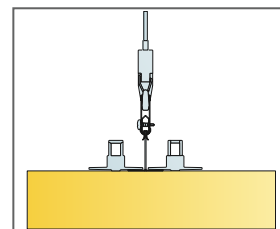

Panels can be suspended underneath each other

INSTALLATION DIAGRAM (M407) FOR ECOPHON SOLO RECTANGLE 2400X1200

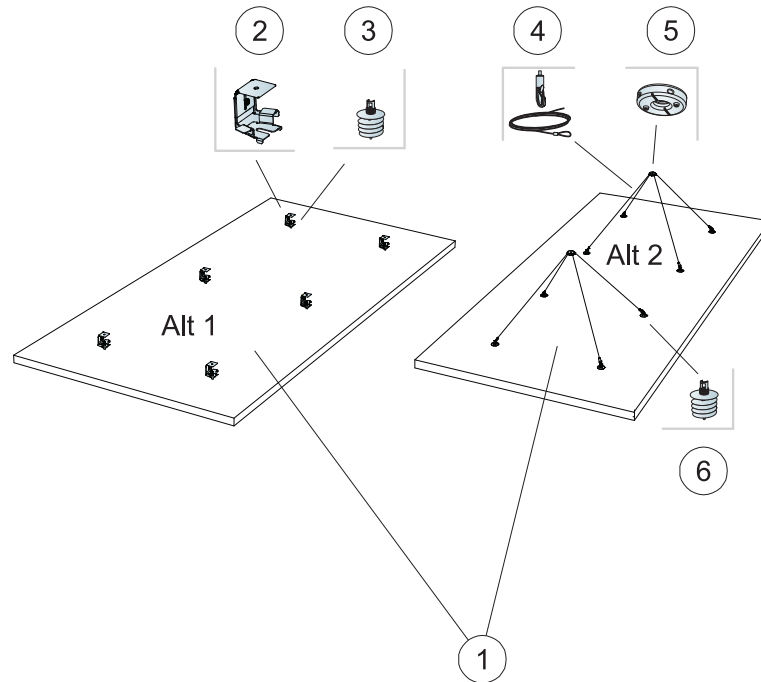

QUANTITY SPECIFICATION (EXCL. WASTAGE)

		Size, mm
		2400x1200
1	Solo Rectangle	2,88m ² /panel
2	Connect Absorber bracket (Alt 3)	6/panel
3	Connect Absorber anchor (Alt 3)	6/panel
4	Connect Adjustable wire hanger (Alt 2)	4/panel
5	Connect One-point fixing (Alt 2)	2/panel
6	Connect Absorber anchor (Alt 2)	8/panel
Δ Min. overall depth of system: $\Delta 1$ 140 mm / $\Delta 2$ 500 mm / $\Delta 3$ 121 mm		-

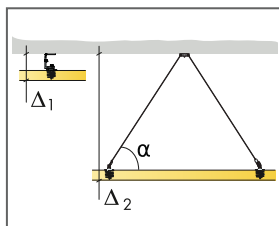

See Quantity specification

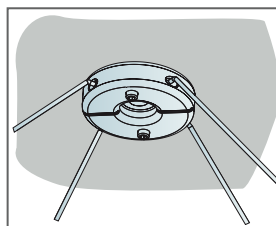

Detail of One-point fixing

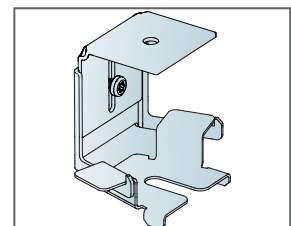

INSTALLATION DIAGRAM (M408) FOR ECOPHON SOLO RECTANGLE 3000X1200

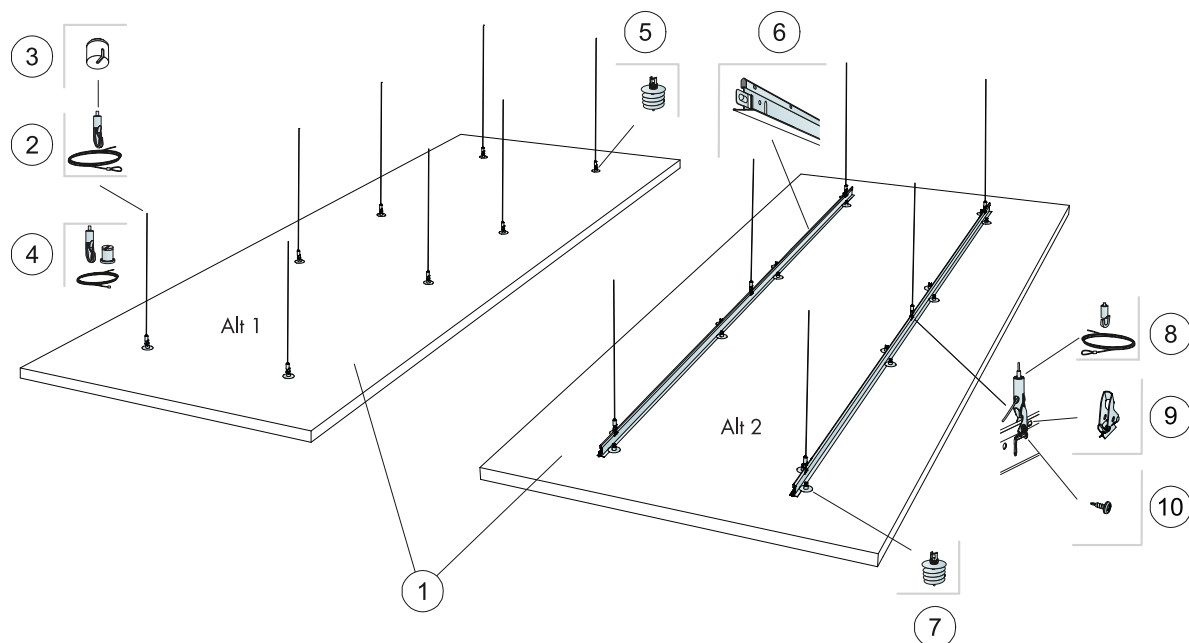

QUANTITY SPECIFICATION [EXCL. WASTAGE]

		Size, mm
		3000x1200
1	Solo Rectangle	3,6m ² /panel
2	Connect Adjustable wire hanger (Alt 1)	8/panel
3	Connect Covering cup (Alt 1, Optional)	8/panel
4	Connect Adjustable wire kit (Alt 1, Optional)	8/panel
5	Connect Absorber anchor (Alt 1)	8/panel
6	Connect T24 Main runner	2/panel
7	Connect Absorber anchor (Alt 2)	16/panel
8	Connect Adjustable wire hanger (Alt 2)	6/panel
9	Connect Adjustable wire hanger	6/panel
10	Connect Installation screw BR	6/panel
Δ Min. overall depth of system: Δ1 140 mm / Δ2 200 mm		-

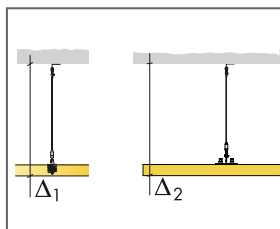

See Quantity specification

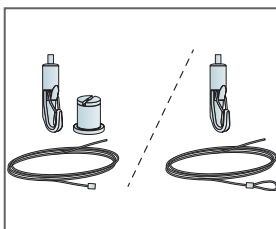

Two types of Adjustable wire solutions

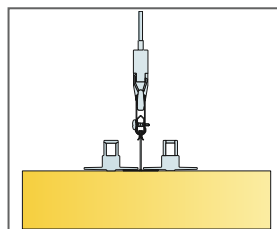

Panels can be suspended underneath each other

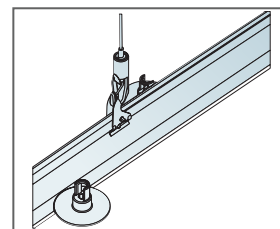

Panels can be suspended underneath each other

INSTALLATION DIAGRAM (M506) FOR ECOPHON SOLO RECTANGLE KIT

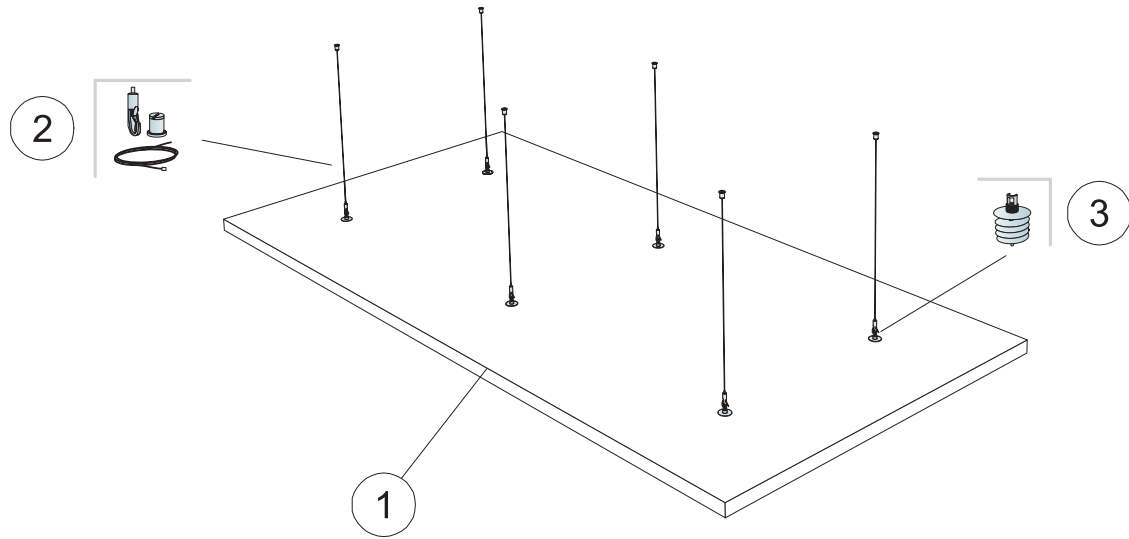

QUANTITY SPECIFICATION (EXCL. WASTAGE)

	Size, mm	
	1800x1200	2400x1200
1 Solo Rectangle Kit	2,16m ² /panel	2,88m ² /panel
2 Connect Adjustable wire kit 1500mm (included)	-	-
3 Connect Absorber anchor (included)	-	-
Δ Min. overall depth of system: Δ 140 mm	-	-
To install Connect Absorber Anchor, use Connect Absorber Anchor Bit.	-	-

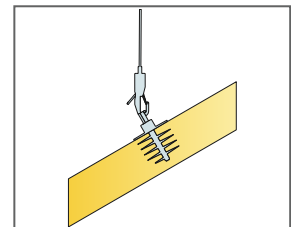
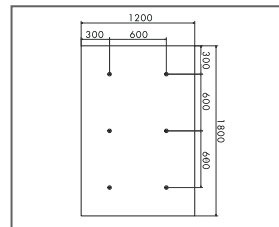
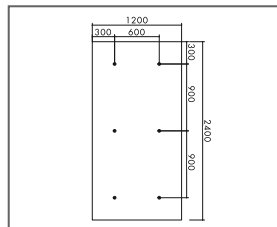
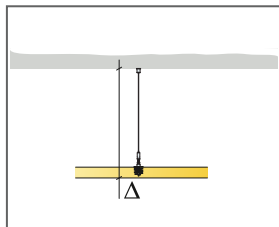

Panels can be installed in angles

INSTALLATION DIAGRAM (M637) FOR ECOPHON SOLO RECTANGLE KIT

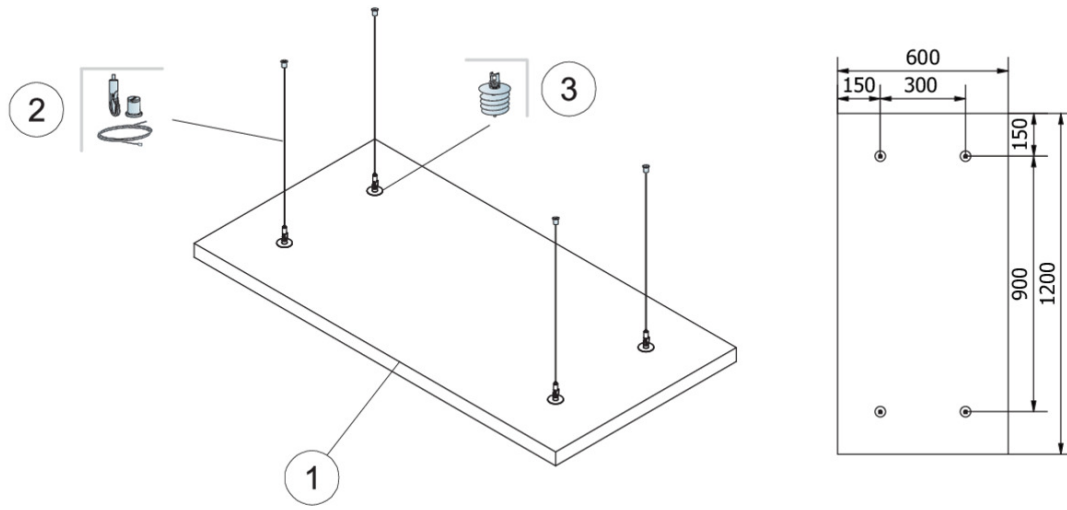

QUANTITY SPECIFICATION (EXCL. WASTAGE)

		Size, mm
		1200x600
1	Solo Rectangle Kit	0,72m ² /panel
2	Connect Adjustable wire kit 1500mm (included)	-
3	Connect Absorber anchor (included)	-
Δ Min. overall depth of system: Δ 140 mm		-
To install Connect Absorber Anchor, use Connect Absorber Anchor Bit.		-

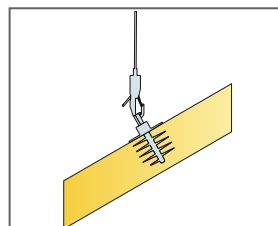
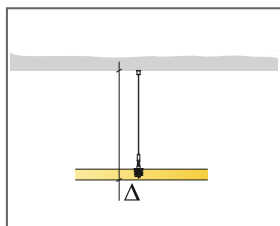

Panels can be installed in angles

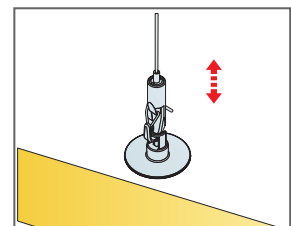

Easily adjustable suspension with Connect Adjustable wire hanger