

Uniclass L73144	July 2011
CI/SfB (52.5)	

ACO Building Drainage

Drainage Systems

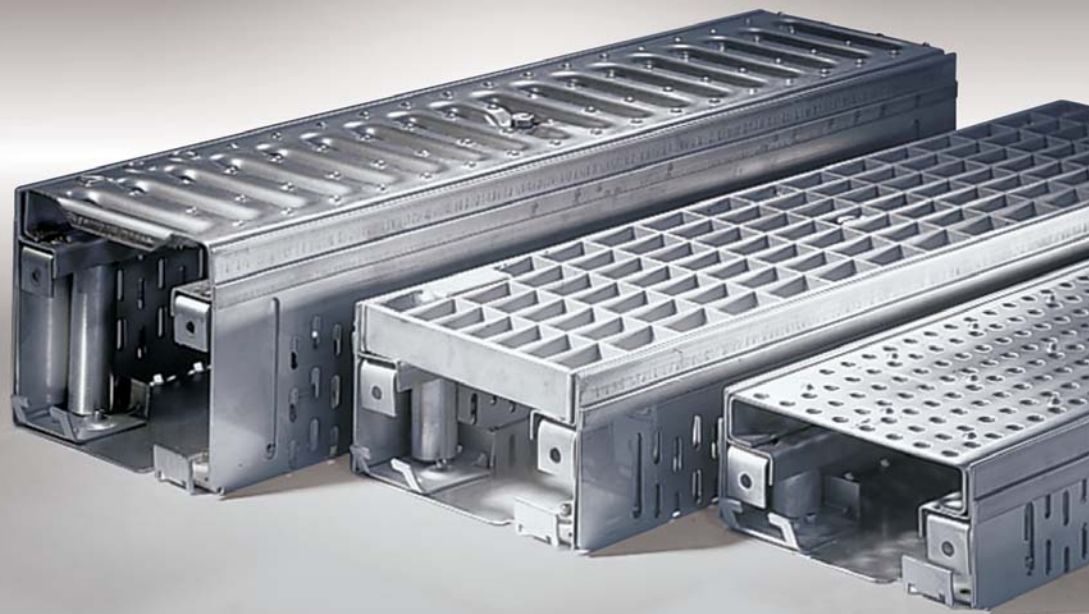

Product catalogue

**ACO FreeDeck - Level Access Flat Roof
and Terrace Drainage Systems**



ACO Building Drainage

Our built environment is becoming ever more complex. Applications are becoming more sophisticated and the increasing pressure of regulations and standards make achieving design, performance and financial goals ever tougher.

ACO Building Drainage is a new concept within the ACO Group. Our mission: to eliminate design risk, to reduce installed and life cost and to deliver exceptional finish and performance in every product application.

We achieve this through three factors:

- High performance materials
- Design experience and project support
- Global manufacturing capacity

Our global resources and fabrication capacity make it possible for us to deliver best value, both with our standard products and with our bespoke designs. Confidence is further assured with quality systems that are in accordance with ISO 9001-2008.

ACO Building Drainage's extensive portfolio includes:

- Roof/Balcony drainage systems
- Wetroom and shower drainage
- Stainless steel gullies and Selecta advanced system
- Standard stainless steel and galvanised steel channels
- Stainless steel and polymer composite access covers
- Grease Management systems
- Stainless steel socketed pipe system
- Anti-flood backflow protection systems
- Bespoke channel drainage systems

ACO Building Drainage is a division of ACO Technologies plc and part of the worldwide ACO Group. The Group has sales in excess of £400 million worldwide with production facilities in the UK, Germany, France, Switzerland, Denmark, Spain, Poland, Czech Republic, Australia and the USA. In total more than 3500 people are employed in 40 countries throughout the world.

Tel: 01462 816666

Fax: 01462 851490

e-mail Enquiries: buildingdrainage@aco.co.uk

website: www.acobuildingdrainage.co.uk



Contents

Linear Deck Drainage Systems	
Introduction and complying with national access regulations	4
Overview and Key features	5
Project Gallery	
ACO FreeDeck in application	6
Features and Benefits	
ACO FreeDeck system	8
Bespoke Solutions	
Design department at your service...	10
Components	
Channels and gratings	11
Adjustable corner, adjustable length and end plates	12
Access grating, access frame, access frame extension, drainage duct	13
Installation	
Inverted roof with level access threshold	14
Warm roof podium deck	15
Inverted roof parapet terrace	16
Specification	
Model specification clause, maintenance, flow performance	17
Rainwater Outlets	
Overview and product features	18

Linear deck drainage systems

Introduction

Applying design to the demands of modern living constantly challenges architects and engineers to conform to new compliances and improve function through choice of building materials.

ACO FreeDeck is an advanced roof and balcony drainage system combining line drainage with point drainage by using an open sided drainage channel system to collect and convey rainwater to drainage points within a raised or suspended deck structure. Rainwater is intercepted at 3 points

- Surface run-off
- Percolation within the deck
- Rainwater outlet positions.



Versatility

ACO FreeDeck is ideally suited for all types of flat roof and terrace construction requiring level access drainage in front of doorways, at the top of stairs or as perimeter drainage against abutments within:

- Warm Roof Construction
- Inverted Roof Construction

Manufactured in galvanised steel or stainless steel, ACO FreeDeck channel is simply laid directly onto the insulation layer or waterproofing membrane. Efficient drainage is provided where pavings are required to be laid "open or closed joint" improving safety for foot traffic and weathered protection of the building fabric.

Complying with national access regulations

ACO FreeDeck channels provide level access drainage in compliance with:

- England and Wales Building Regulations ACCESS TO AND USE OF BUILDING: Approved Document M
- Scottish Building Standards DOMESTIC AND NON DOMESTIC HANDBOOK: Section 4
- Northern Ireland Building Regulations, DFP Technical Booklet R:2006 ACCESS TO AND USE OF BUILDINGS: Section 7

National access regulations

ACO FreeDeck drainage systems assist in the compliance with national access regulations where drainage channels are used on structural decks and balconies as a level access solution by combining threshold access and rainwater interception within a single drainage system.

Systems

FreeDeck channel is available in two systems according to construction and function requirement.

- Height adjustable in three depths according to thickness of pavings and the need for level threshold access.
- Fixed height in two depths for general deck drainage

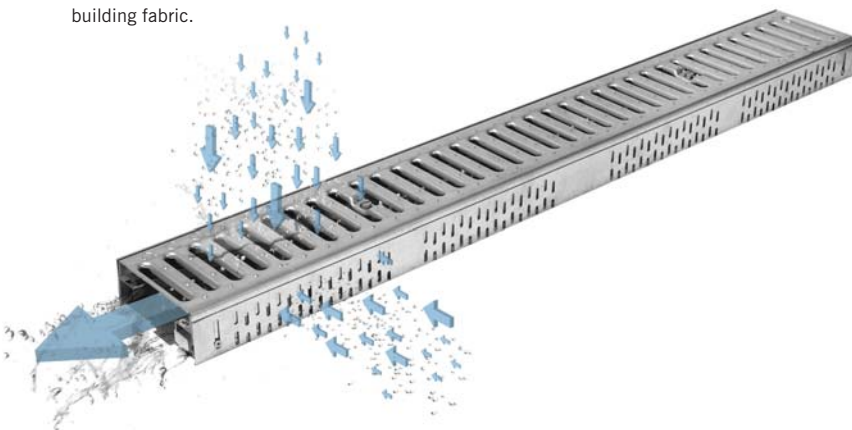

Linear deck drainage systems

Overview

ACO FreeDeck is the adaptable solution to managing rainwater on all types of raised deck construction.

- Provides drainage at point of access
- Level threshold compliant
- Versatile drainage of terraces, balconies, landscaped and flat roofs
- Safer access for all age groups and those with mobility restrictions
- Discreet and attractive drainage solution
- Eliminates ponding



Key features

- ACO FreeDeck is used for rainwater drainage and safe access in a variety of applications.
 - Flat roof drainage
 - Rainwater intercept at thresholds
 - Document M compliance for drained level access
 - Façade drainage
 - Glazed structures
- Drainage for all types of suspended deck construction.
 - Warm and Inverted flat roofs
 - Green roofs
 - Podia and terraces
- A system that details into all types of flat roof finishes.
 - Paviers on supports
 - Paving flags on sand or cement bedding
 - Brick paviers on sand bedding
- Practical within all applications throughout building life.
 - Rapid installation
 - Tamper resistant gratings
 - Vermin proof
- A drainage system that protects and maintains the building fabric.
 - Prevents saturation at critical point between wall and deck
 - Reduces effects of efflorescence
 - Stops frost attack on masonry

ACO FreeDeck in application

Project gallery



ACO FreeDeck system

Features and benefits

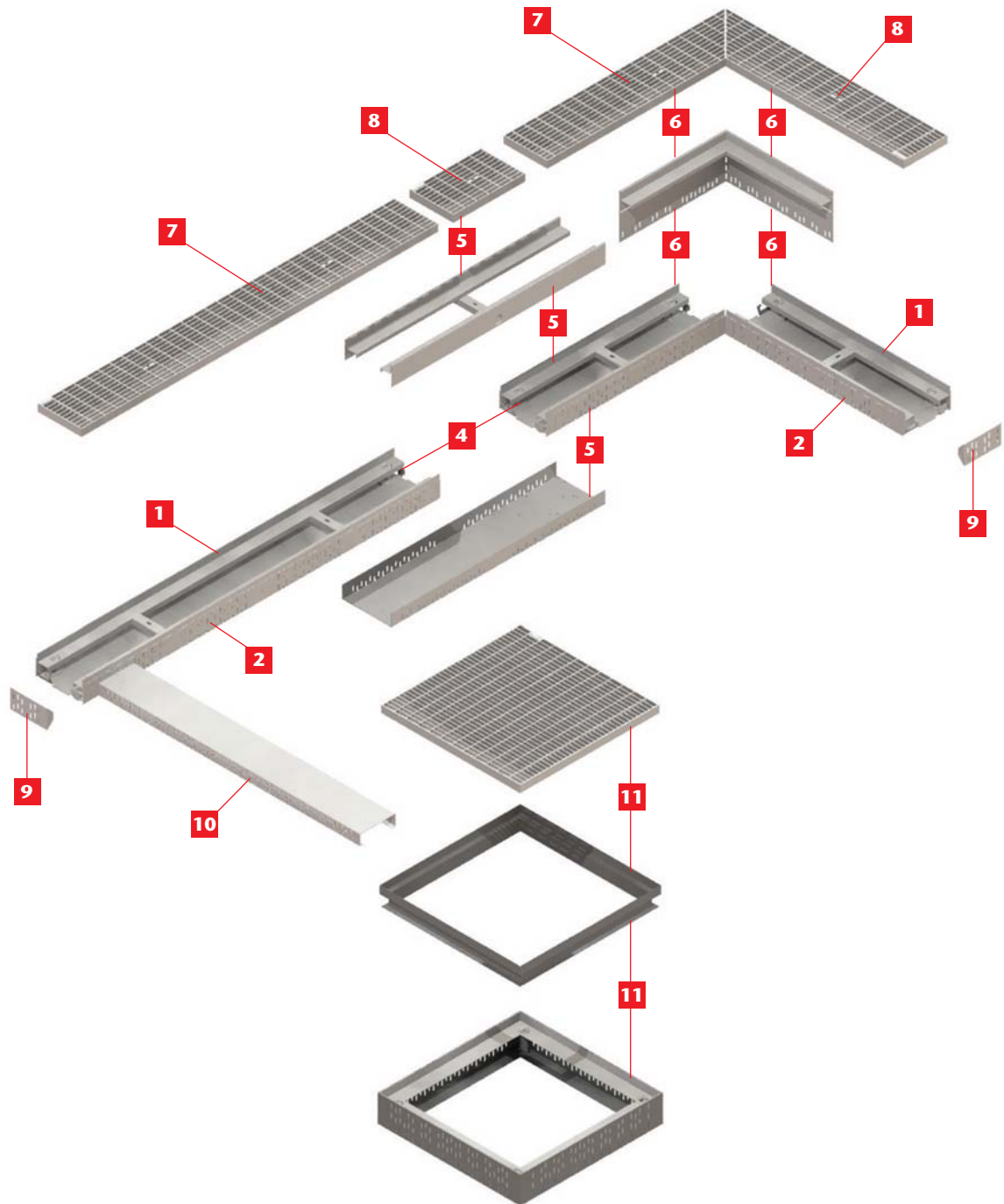

ACO FreeDeck system

Features and benefits



1 Five channel systems in galvanised steel or stainless grade 304 for warm and inverted roofs are available as a Fixed Height system with a choice of inverts to suit hydraulic demand, or Adjustable Height system allowing precise match to finished floor level in level threshold situations.

2 The FreeDeck system is designed to efficiently remove surface rainwater and low level percolation through perforated sidewalls.

3 Height Adjustable channels correct slope and level according to channel type (shallow section 55mm-77mm, intermediate section 75mm-105 and deep section 105mm-165mm) using a flat blade screwdriver.



4 Fast track "drop and lock" system for connecting channel lengths is quick and simple, requiring no tools.

5 Length correction to Height Adjustable channel runs* is achieved without need for cutting by using the Adjustable Length assembly. Fixed Height runs are cut to length.

6 Corners of 90° and greater for both systems benefit from the Adjustable Corner fitting which eliminates templates and reduces site work required to form fully supported angles.



7 Gratings are available as mesh or slot patterns conforming to FACTA Load Class A.

8 Gratings are securely fastened to Height Adjustable and Fixed Height channels using lock screws and simply cut down for length correction and forming of corners.

9 Clip in End Plates prevent foreign matter from entering the drainage system.

10 Concealed low profile Drainage Duct economically connects channels with offset rainwater outlet positions whilst collecting percolation and low level water.

11 Rainwater Outlets are easily top accessed through Access Grating and Frames suitable for both Fixed Height and Height Adjustable channel systems.



***IMPORTANT**

Do not cut Height Adjustable channels as this will cause loss of adjustment.

A comprehensive range of ACO Rainwater Outlets is available for use with FreeDeck channel systems. Refer to page 18.

Bespoke solutions

Design department at your service...

The challenge - a green roof drainage system accommodating both surface and subsurface water with the added requirement to incorporate flow from additional rainwater down pipes, all of which have to drain to only one outlet. To minimise construction time the contractor requested a number of modular design features.

Overall depth of the system caters for both low level water percolation (1) as well as providing the necessary capacity (2) to achieve a single outlet discharge point.

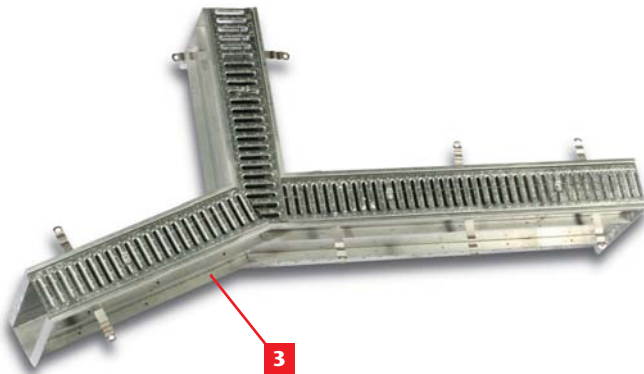
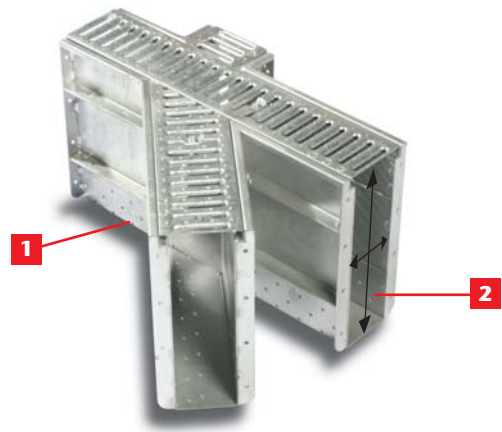

Integration of the rainwater down pipes was achieved without need for additional site-work through fabrication of special corners which included the required branch unit (3).

Practical and economic considerations led to the use of pre-galvanised sheet material with specially designed ribs (4) to reinforce the drainage structure, a feature necessary because of the overall depth of the system.

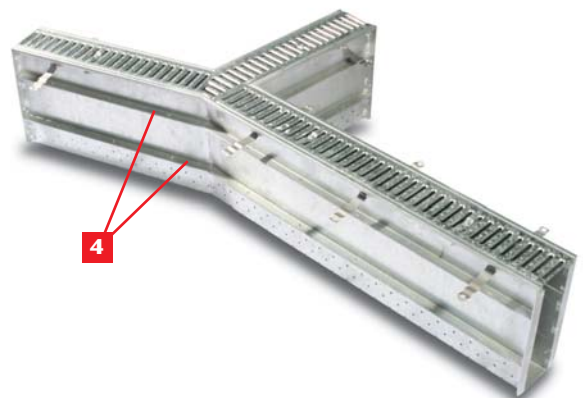

Components

Note: The mixing of stainless steel and galvanised components will result in bimetallic corrosion and is to be avoided.

Channels

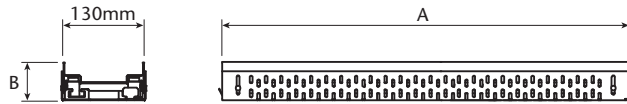

Description	Part No. Galvanised	Part No. Stainless	A mm	B mm	Weight kg
Adjustable Channel - shallow section	36940	36942	500	55 - 77	3.1
	36941	36943	1000	55 - 77	4.9
Adjustable Channel - intermediate section	36789	36837	500	75 - 105	3.3
	36788	36836	1000	75 - 105	5.4
Adjustable Channel - deep section	36807	36855	500	105 - 165	3.8
	36806	36854	1000	105 - 165	6.4
Fixed Height Channel - shallow section	38147	38222	500	50	1.1
	38146	38221	1000	50	2.0
	38145	38220	2000	50	4.0
Fixed Height Channel - intermediate section	36982	36987	500	75	1.5
	36981	36986	1000	75	2.65
	36980	36985	2000	75	4.8

Gratings

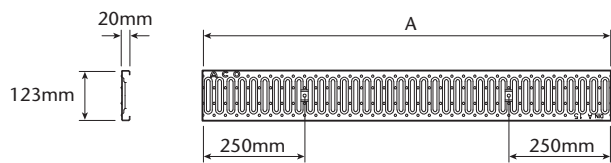

Description	Part No. Galvanised	Part No. Stainless	A mm	FACTA Load Class	Weight kg
Slotted Grating - 10mm x 80mm slot	00277	00273	500	A	1.0
	00276	00272	1000	A	2.2

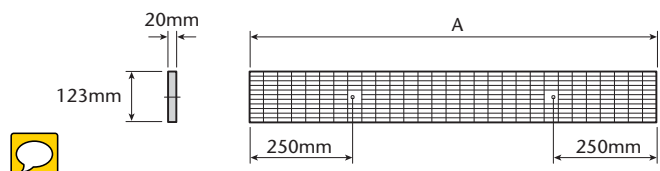

Description	Part No. Galvanised	Part No. Stainless	A mm	FACTA Load Class	Weight kg
Mesh Grating - 14mm x 30mm mesh	36952	36954	500	A	1.6
	36953	36955	1000	A	3.0

Note: Other design gratings, such as Heelsafe stainless steel and Perforated stainless steel and galvanised steel are also available to special order.

Components

Adjustable Corner

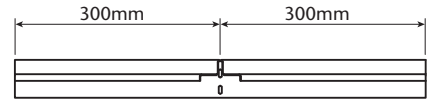

Description	Part No. Galvanised	Part No. Stainless	Weight kg
Adjustable Corner (Adjustable Channels only)	38634	38643	1.5
Adjustable Corner (Fixed Height Channels only)	38634F	38643F	1.5

Adjustable Length

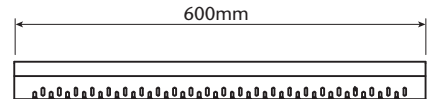
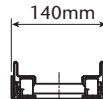

Description	Part No. Galvanised	Part No. Stainless	Weight kg
Adjustable Length - shallow section (Adjustable Channels only)	36948	36949	2.1
Adjustable Length - intermediate section (Adjustable Channels only)	36790	36838	2.2
Adjustable Length - deep section (Adjustable Channels only)	36808	36856	2.9

End Plates

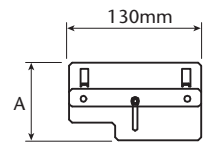

Description	Part No. Galvanised	Part No. Stainless	A mm	Weight kg
End Plate - shallow section (Adjustable Channels only)	36950	36951	55 - 77	0.1
End Plate - intermediate section (Adjustable Channels only)	36793	36841	75 - 105	0.1
End Plate - deep section (Adjustable Channels only)	36811	36859	105 - 165	0.2

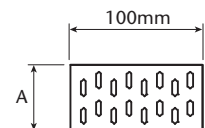

Description	Part No. Galvanised	Part No. Stainless	A mm	Weight kg
End Plate - shallow section (Fixed Height Channels only)	38148	38223	25	0.1
End Plate - intermediate section (Fixed Height Channels only)	36983	36988	50	0.07

Components

Access Grating

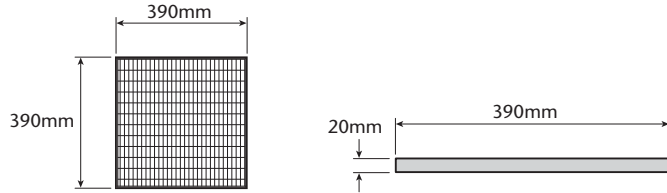

Description	Part No. Galvanised	Part No. Stainless	Weight kg
Access Grating - 14mm x 30mm mesh FACTA Load Class A	36754	36760	3.5

Access Frame

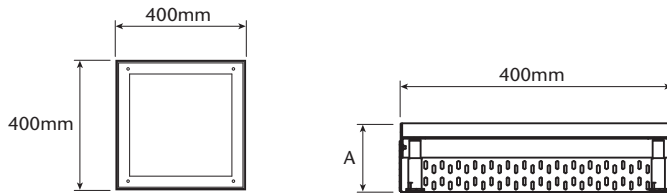

Description	Part No. Galvanised	Part No. Stainless	A mm	Weight kg
Access Frame - adjustable	38801	38803	75 - 105	3.1
Access Frame - fixed height	38150	38156	50	5.7

Access Frame Extension

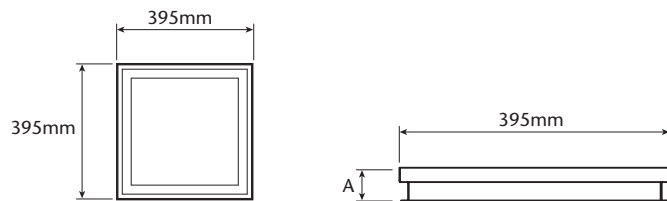

Description	Part No. Galvanised	Part No. Stainless	A mm	Weight kg
Access Frame Extension	38685	38686	50	1.3
	38687	38688	75	1.9

Drainage Duct

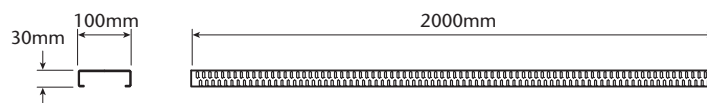

Description	Part No. Galvanised	Part No. Stainless	Weight kg
Drainage Duct	00328	00307	2.4

Installation

Inverted roof with level access threshold

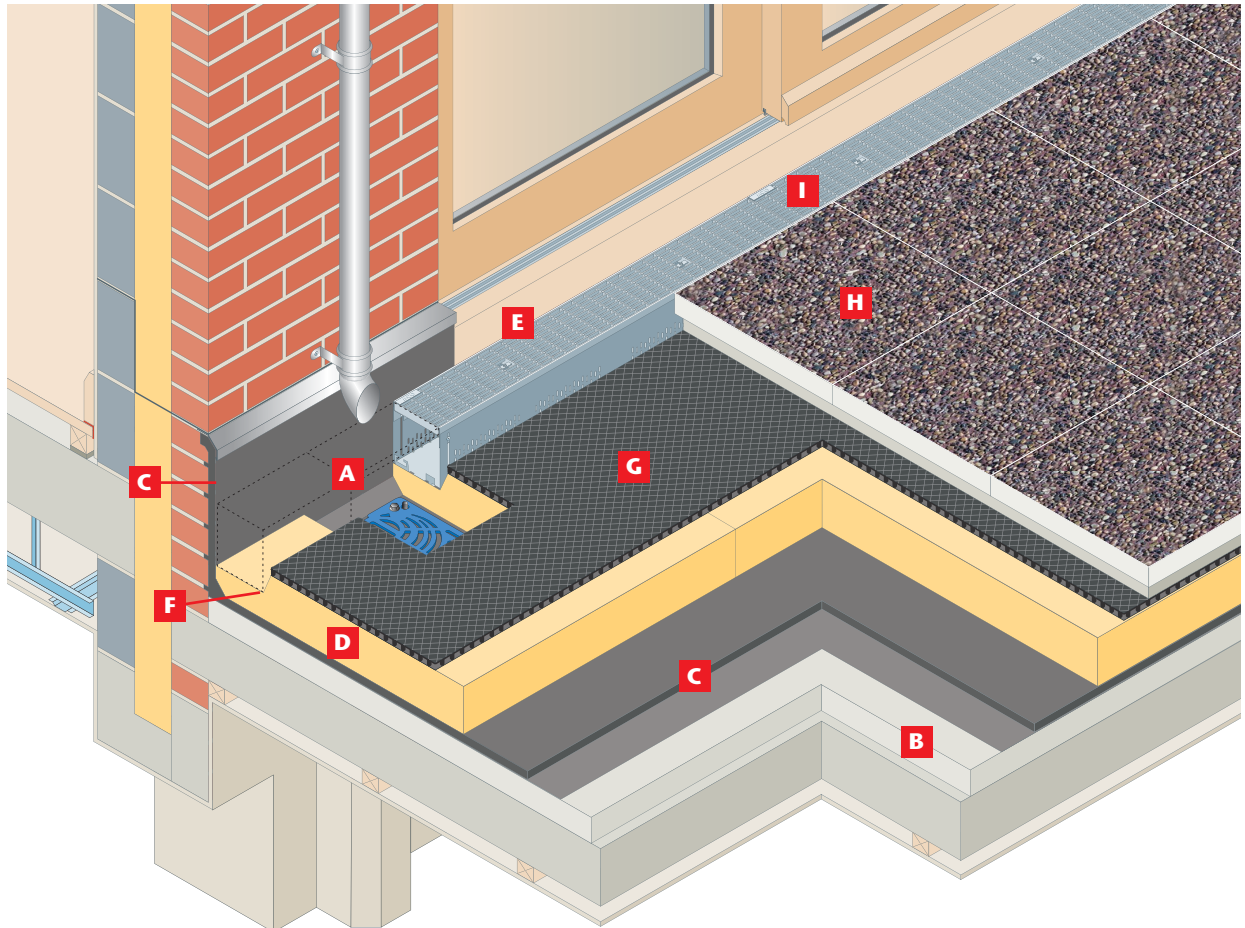

- A** Form hole in deck and locate ACO Balcony Outlet to screed level.
- B** Lay screed to falls over structural slab.
- C** Lay isolating layer and two coats of mastic asphalt keyed into brickwork and beneath cill.

- D** Lay insulation board cut around outlet and flush to asphalt upstand. Ensure that insulation board is one course below cill regardless of overall board thickness specified.
- E** Position Adjustable Channel and adjust to cill height.

- F** Chamfer edge of insulation away from channel to improve percolation.
- G** Lay drainage mat.
- H** Lay paving slabs on lean mix base.
- I** Fit channel gratings and secure with lock screws provided.

Installation

Warm roof podium deck

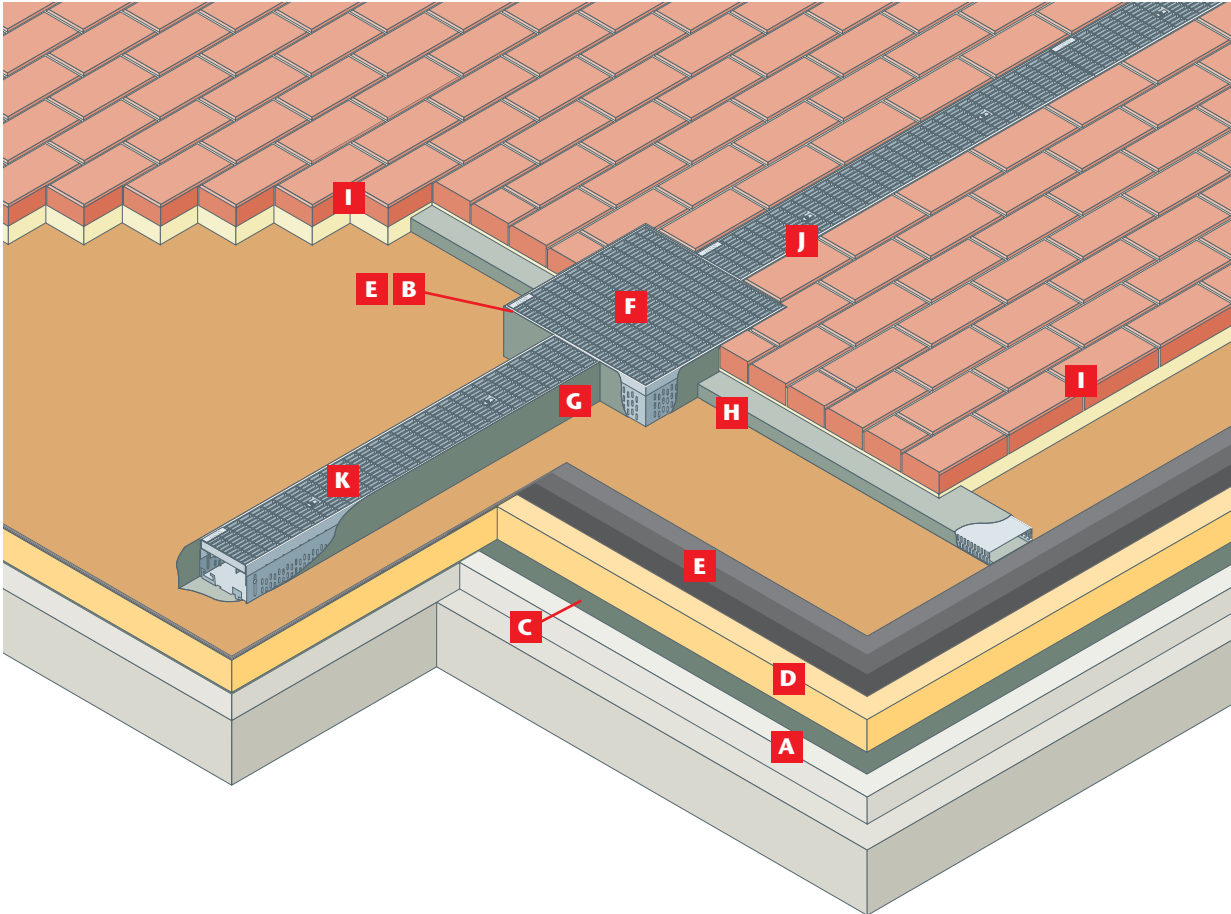

A Lay screed to falls over structural slab.

B Form hole in deck and locate ACO HP rainwater outlet level with surface of insulation (hidden detail).

C Lay vapour barrier.

D Lay and bond roofing grade insulation to vapour barrier.

E Lay and bond built up felt waterproofing to insulation and dress into outlet (hidden detail).

F Position height adjustable Access Grate and Frame over ACO rainwater outlet.

G Butt joint channels to Access Frame and wrap with geotextile filter membrane. Cut away filter membrane at butt joint to ensure free flow.

H Butt joint concealed Drainage Ducts to Access Frame and wrap with geotextile filter membrane. Cut away filter membrane at butt joint to ensure free flow.

I Prepare sharp sand bed and lay brick paviors.

J Adjust channel height to finished paved level.

K Fit channel gratings and secure with lock screws provided.

Installation

Inverted roof parapet terrace

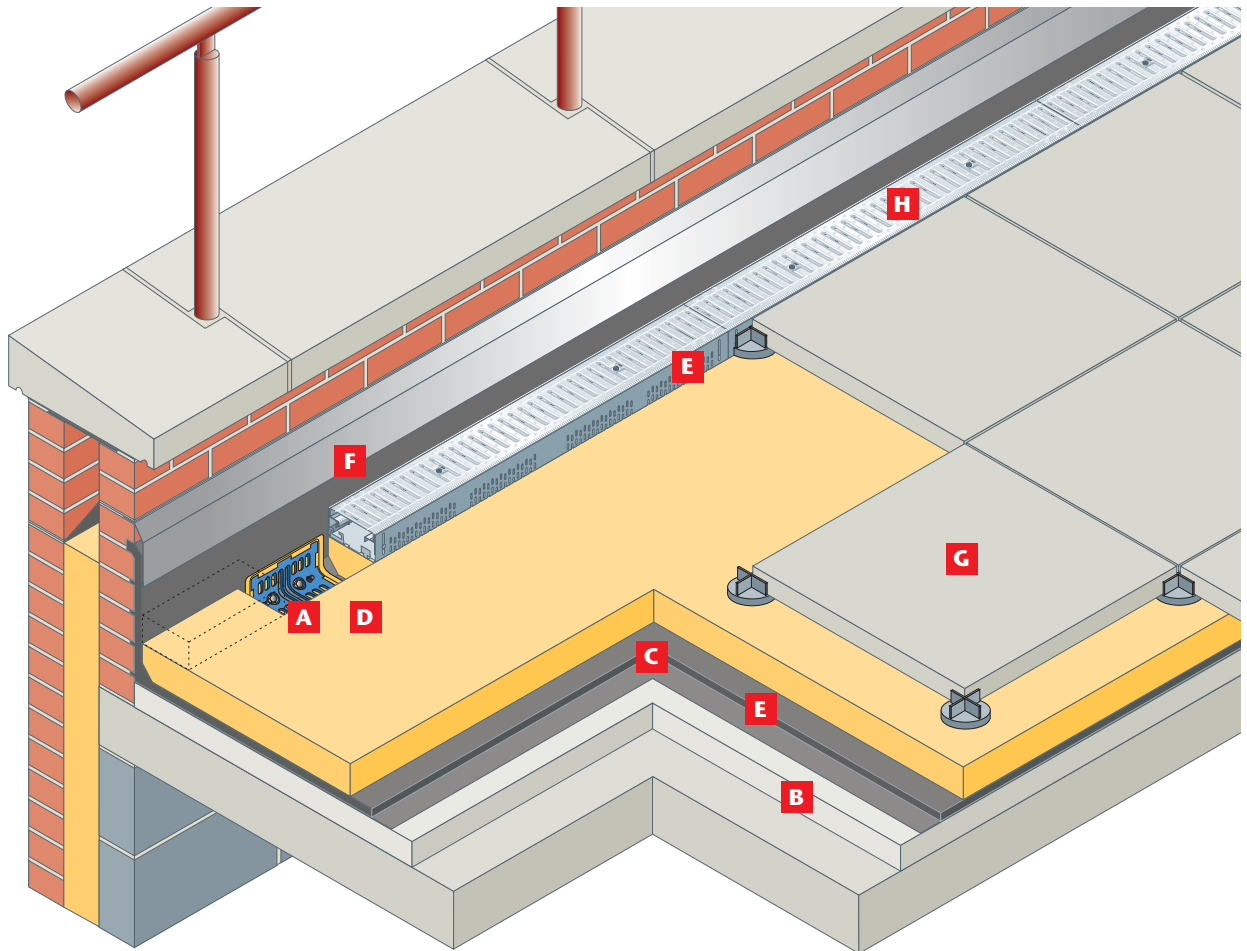

- A** Form hole in wall, position ACO Two Way outlet and connect pipework.
- B** Lay screed to falls over structural slab.
- C** Lay isolating layer and two coats of mastic asphalt keyed into brickwork and fitted with flashing.

- D** Lay insulation board cut around rainwater outlet and flush to asphalt upstand.
- E** Position appropriate channel to be laid level with combined depth of paving slabs on paving supports.

- F** Install channel flush to wall.
- G** Ballast insulation with paving slabs laid on supports.
- H** Fit channel gratings and secure with lock screws provided.

Specification

Model specification clause

ACO Building Drainage - FreeDeck Drainage System

Refer NBS R10 Gravity Rainwater Drainage Systems. Subsection 365.

Suitable for drainage of warm and inverted roof construction in reinforced decks, uninsulated structural slabs, restricted excavations within podia, balconies, paved areas and terraces.

Manufacturer: ACO Building Drainage
ACO Business Centre, Caxton Road, Bedford, Bedfordshire MK41 0LF
Tel: 01462 816666 Fax: 01462 851490
Email: buildingdrainage@aco.co.uk

Description: Linear, percolating rainwater drainage channels consisting of shallow form perforated channel sections, slotted or mesh gratings c/w end stops, corners and outlets.

Material: Mild steel hot dip galvanised to BS EN ISO 1461:1999 or Stainless Steel grade 304.

Product: Channels - adjustable or fixed height. Gratings - lockable with slot or mesh openings.

Load - FACTA Load Class A.

Literature: Consult ACO Building drainage technical literature for details.

Link to web: www.acobuildingdrainage.co.uk

Design: ACO Building Drainage Technical Services provide design and specification.

Maintenance

ACO FreeDeck systems are generally low maintenance but the following should be noted.

- Drains should be inspected bi-annually and kept clear of blockages.
- Wear protective gloves when handling metal work.
- Do not sweep rubbish into the drain.
- Gratings are top accessible using a flat blade screwdriver to undo the recessed locks.
- Grates should be cleaned with a natural or plastic bristle brush.
- Flush through with clean water.
- Never use caustic or bleach drain cleaners nor acid paving cleaners as these will strip the protective galvanizing.
- Reassemble all parts noting any losses.

Flow performance

ACO Hydro design software is used to calculate FreeDeck channel drainage requirements in conjunction with ACO flat roof rainwater outlets. For assistance with all drainage design contact ACO Building Drainage Technical services 01462 816666.

Flow performance is expressed in litres per second per metre run of channel. Mesh gratings have greater free area than slotted gratings.



Rainwater outlets

Overview

The ACO Building Drainage range of rainwater outlets is ideally suited for use with FreeDeck drainage systems in warm roof and inverted roof construction using mastic asphalt, high performance felts and single ply membranes. Outlets are manufactured in diecast aluminium grade LM6 and are suitable for connection to cast iron pipework conforming to BS EN 877 or to uPVC "O" ring socket pipe to BS 4514.

Product features

- HP outlets are manufactured with either spigot or threaded pipe connections.
- Waterproofing membranes are positively secured into the mouth of the outlet by means of a compression clamp held by bolted fixings ensuring integrity of seal between clamp and outlet body.
- Standard HP Vertical Spigot outlets are available with domed gratings. Flat gratings are also available for discreet location within FreeDeck Access Frames.
- HP Two Way outlets are screw threaded to provide a watertight connection where inaccessible pipework passes through the structure. Threaded adapters are also supplied.
- HP Balcony outlets are supplied with flat gratings only and connect pipework between different levels of balcony.
- All fixings used are stainless steel.

The ACO Building Drainage Technical Department can advise on flat roof drainage requirements and a 48 page brochure, **Product Catalogue and Specifiers Design Guide - 2nd Edition** is available upon request. To request a brochure telephone 01462 816666

HP Vertical Spigot outlet



ACO Vertical Spigot rainwater outlets are ideal for all types of warm roof and inverted roof construction.

Vertical Spigot rainwater outlets are suitable for connection to pipes with 82.5mm, 110mm and 160mm outside pipe diameters.

HP Two Way screw outlet



ACO Two Way outlets are located at the junction between flat roof and parapet wall providing "through the wall" drainage to external rainwater pipes and hoppers. Outlets are parallel threaded for connection to taper male, screw threaded adapters to ensure a completely watertight connection to pipes with 55mm, 82.5mm and 110mm outside pipe diameters.

HP Balcony spigot outlet



ACO Balcony outlets are designed to be installed against an abutment wall and permit the introduction of successive rainwater pipes discharging from higher level balcony areas. Balcony outlets are suitable for connection to pipes of 82.5mm and 110mm outside pipe diameters.

ACO Technologies plc

- ACO Building Drainage
- ACO Water Management
Civils + Infrastructure
Urban + Landscape
- ACO Sport
- ACO Wildlife
- ACO Technic
- ACO Home & Garden

ACO Building Drainage

A division of ACO Technologies plc

ACO Business Centre

Caxton Road

Bedford

Bedfordshire

MK41 0LF

Tel: 01462 816666

Fax: 01462 851490

e-mail: buildingdrainage@aco.co.uk

www.acobuildingdrainage.co.uk

The ACO Group: A strong family you can depend on.

© July 2011 ACO Technologies plc. All reasonable care has been taken in compiling the information in this document. All recommendations and suggestions on the use of ACO products are made without guarantee since the conditions of use are beyond the control of the Company. It is the customer's responsibility to ensure that each product is fit for its intended purpose, and that the actual conditions of use are suitable. This brochure and any advice is provided by ACO Technologies plc (the Company) free of charge and accordingly on terms that no liability including liability for negligence will attach to the Company or its servants or agents arising out of or in connection with or in relation to this brochure or any such advice. Any goods supplied by the Company will be supplied solely upon its standard conditions of sale, copies of which are available on request. The Company's policy of continuous product development and improvement renders specifications liable to modification. Information provided in this brochure is therefore subject to change without prior notification.

